



UNITED NATIONS
INDUSTRIAL DEVELOPMENT ORGANIZATION



Technology Compendium for Energy Efficiency and Renewable Energy Opportunities in Pharma Sector

Sikkim Pharma Cluster



UNITED NATIONS INDUSTRIAL DEVELOPMENT ORGANIZATION

September 2020



Disclaimer

This document is prepared to provide overall guidance for conserving energy and costs. It is an output of a research exercise undertaken by Confederation of Indian Industry (CII) supported by the United Nations Industrial Development Organization (UNIDO) and Bureau of Energy Efficiency (BEE) for the benefit of the **Pharma Industry located at Sikkim, India**. The contents and views expressed in this document are those of the contributors and do not necessarily reflect the views of CII, BEE or UNIDO, its Secretariat, its Offices in India and elsewhere, or any of its Member States.

Promoting Energy Efficiency and Renewable Energy in Selected MSME Clusters in India

(A GEF funded project being jointly implemented by UNIDO & BEE)



UNITED NATIONS
INDUSTRIAL DEVELOPMENT ORGANIZATION



Compendium of

Energy Efficiency and Renewable Energy Technologies for Sikkim Pharma Cluster

September 2020

Developed under the assignment

Scaling up and expanding of project activities in MSME Clusters

Prepared by



Confederation of Indian Industry
125 Years - Since 1895

CII Sohrabji Godrej Green Business Centre
Survey No.64, Kothaguda Post, R R District,
Hyderabad, Telangana 500084
INDIA



Acknowledgement

Acknowledgement

This assignment was undertaken by Confederation of Indian Industry (CII) as a project management consultant under the Global Environment Facility (GEF) funded project ‘Promoting Energy Efficiency and Renewable Energy in selected MSME clusters in India.’ The Technology Compendiums are meant to serve as an informative guide to the clusters that the project is currently working in and also to the other potential clusters across the country.

CII would like to express its gratitude to United Nations Industrial Development Organization (UNIDO) and Bureau of Energy Efficiency (BEE) for having provided the guidance in the completion of this assignment.

CII would like to specially thank all the professionals for their valuable contributions in finalizing the different technology compendiums developed under the assignment. CII is grateful to Mr. Abhay Bakre, Director General, BEE, Mr R K Rai, Secretary, BEE and Mr. Milind Deore, Director, BEE for their support and guidance during the assignment. CII would like to express its appreciation to Mr. Sanjaya Shrestha, Industrial Development Officer, Energy Systems and Infrastructure Division, UNIDO, for his support in execution of the assignment. We would like to thank Mr. Suresh Kennit, National Project Manager, and the entire Project Management Unit (PMU) for their timely coordination and valuable inputs during the assignment.

CII would like to take this opportunity to thank all the industries, local service providers and equipment suppliers for their active involvement and valuable inputs in the development of the technology compendiums. We extend our appreciation to the different Industry Associations in the clusters for their continuous support and motivation throughout the assignment.

Finally, we would like to thank each and every personnel from CII team who have been actively involved at every step of the compilation and whose tireless and valuable efforts made this publication possible.

CII Team

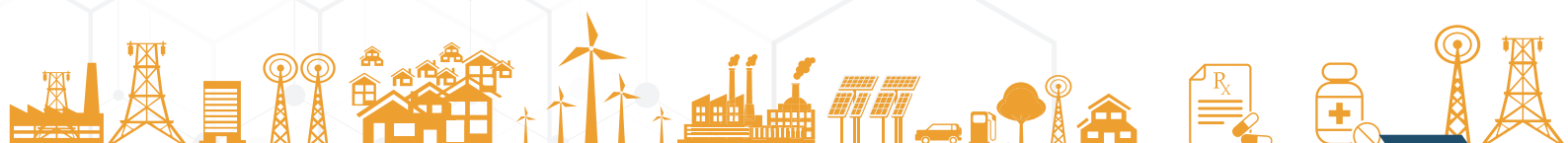
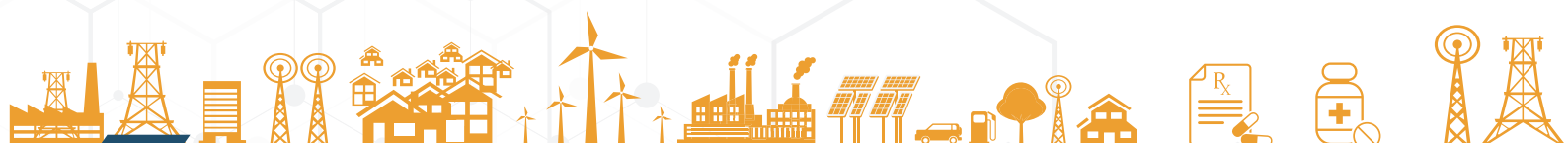
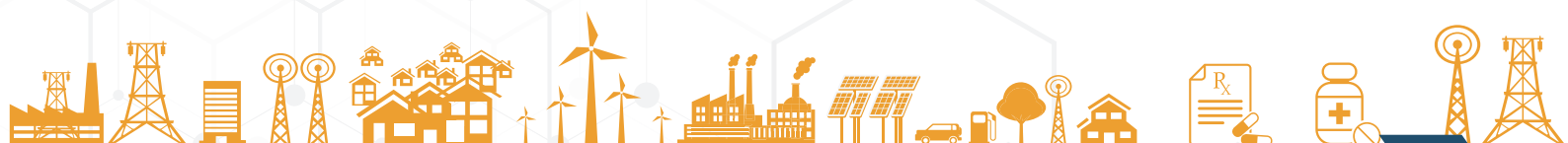

Table of Contents

List of Figures	8
List of Tables	9
List of Abbreviations.....	11
Unit of Measurements	14
About the Project	17
About the Technology Compendium	19
Executive Summary	21
1. Indian Pharmaceutical Sector	25
1.1 Background	25
1.2 Pharma Sector Growth and Revenue.....	27
1.3 Sikkim Industrial Cluster.....	29
2. Energy Consumption Pattern	31
2.1 Energy Consumption	31
2.2 Pharma Sector – Manufacturing Process	32
2.3 Technology Status in Sikkim Cluster.....	34
3. Energy Efficiency Opportunities	37
3.1 Energy Efficiency in Sikkim Pharma Cluster.....	37
3.2 Energy Efficiency Measures	38
3.2.1 Energy Efficiency in Steam Systems	39
3.2.2 Energy Efficiency in Refrigeration Systems.....	40
3.2.3 Energy Efficiency in Utilities	41
3.2.4 Best Practices and Key Indicators for Energy Efficiency.....	43
4. Energy Efficient Technologies – Case Studies	47
4.1 Case Studies in Steam Generation and Distribution	49
4.1.1 Conversion of HSD-fired Boiler to Biomass-fired Boiler	49
4.1.2 Condensate Recovery System	53
4.1.3 Steam Operated Pumping Traps.....	58
4.1.4 Steam Driven Heat Pump.....	61
4.2 Case Studies in Refrigeration Systems	66
4.2.1 VFD for Screw Chiller Compressor	66
4.2.2 De-Superheater for Chiller Compressors	69
4.2.3 kVAr Energy Compensator for Chiller Compressor.....	73
4.2.4 VFD for Chilled Water Pumps	77
4.2.5 Evaporative Condenser	81
4.2.6 Electronically Commutated Motors for AHUs.....	86
4.2.7 Online Condenser Cleaning System	90
4.2.8 Replace three port with two-port valves in AHUs and install VFD for chilled water pump	94
4.2.9 Active refrigerant agent addition in lube oil for chillers	97
4.2.10 Optimize Chilled Water Pumping System	100



4.3 Case Studies – Utilities	104
4.3.1 VFD for Air Compressor.....	104
4.3.2 Energy Efficient Pumps	107
4.3.3 IoT-based Water Management System	110
4.3.4 Replacement of plant HP compressor with LP compressor	114
4.4 Case Studies – Renewable Energy	117
4.4.1 Solar rooftop system	117
4.4.2 Solar-Wind Hybrid system.....	121
5. Conclusion	125
Bibliography	129



List of Figures

Figure 1: Breakup of the Indian Pharma sector	25
Figure 2: Structure of Indian Pharmaceutical sector	26
Figure 3: Scheduled and Non-Scheduled formulations in India.....	27
Figure 4: Market size and exports from India	28
Figure 5: Energy Cost – Breakup	31
Figure 6: Tablet compression	33
Figure 7: Energy Efficiency Approach	37
Figure 8: Energy Consumption Overview	38
Figure 9: Typical condensate recovery system.....	53
Figure 10: Heat content in condensate.....	54
Figure 11: Steam Loss Chart.....	58
Figure 12: Schematic of Heat pump	61
Figure 13: VAM working	62
Figure 14: Vapour Compression Cycle	69
Figure 15: WHR from chiller compressor.....	70
Figure 16: kVAR energy compensator.....	73
Figure 17: Existing pumping layout	77
Figure 18: Existing Condenser System	81
Figure 19: Evaporative Condenser	82
Figure 20: EC Fan	86
Figure 21: Schematic of Online Condenser Cleaning System	90
Figure 22: Three element control for AHUs	94
Figure 23: Two port control for AHUs	95
Figure 24: Oil coagulating inside copper tube	97
Figure 25: Protective layer formation	98
Figure 26: Present pumping system	100
Figure 27: Proposed system for chilled water pumping.....	101
Figure 28: Capacity control of compressor	104
Figure 29: Chilled Water Pumping Systems	107
Figure 30: Pump Characteristic Curve	107
Figure 31: Solar Irradiance.....	117
Figure 32: Solar wind hybrid system	121
Figure 33: Hybrid mill connected to supply	122
Figure 34: Hybrid mill connected to loads.....	122
Figure 35: Unit Abatement Cost - Energy Efficient Technologies.....	128

List of Tables

Table 1: Energy Efficiency Technologies – Attractiveness and Investment.....	22
Table 2: Major players in Pharmaceutical sector	28
Table 4: Technology Status – Sikkim Cluster	34
Table 5: Energy Efficiency Measures in Steam Generation and Distribution Systems.....	39
Table 6: Energy Efficiency in Refrigeration Systems	40
Table 7: Energy Efficiency in Utilities	41
Table 8: Best Practices for Energy Efficient Operations	43
Table 9: Energy – Key Performance Indicators.....	45
Table 10: Case Studies for Pharma Sector	47
Table 11: Boiler and Fuel Parameters	49
Table 12: Cost Benefit Analysis – Energy Efficient Boiler	51
Table 13: Vendor details – Energy Efficient Boiler	52
Table 14: Cost Benefit Analysis – Condensate Recovery Systems	55
Table 15: Implementation Details - Condensate Recovery System	56
Table 16: Vendor Details – Condensate Recovery Systems.....	57
Table 17: Cost Benefit Analysis – Installation Steam Operated Pumping Traps.....	59
Table 18: Vendor Details – Steam Operated Pumping Traps	60
Table 19: Technical specification for VAM.....	62
Table 20: Cost Benefit Analysis – Heat Pump	64
Table 21; Vendor Details – Steam Driven Heat Pump	65
Table 22: Operating Parameters of compressors	66
Table 23: Cost Benefit Analysis – VFD for Refrigeration Compressor.....	67
Table 24: Vendor details – VFD for Refrigeration Compressor.....	68
Table 25: Key technical parameters of de super heater.....	70
Table 26: Cost Benefit Analysis – Installation of Desuperheater	71
Table 27: Reference Plant Implementation - De-superheater.....	72
Table 28: Vendor details – De-superheater for Compressors.....	72
Table 29: Electrical parameters	73
Table 30: Cost Benefit Analysis – kVAr Energy Compensator.....	74
Table 31: Reference Plant Implementation – kVAr Compensator	75
Table 32: Vendor Details – kVAr Energy Compensator.....	76
Table 33: Cost Benefit Analysis – VFD for chilled water pump	78
Table 34: Reference Plant Implementation – VFD for chilled water pump	79
Table 35: Vendor Details – VFD for chilled water pump	80
Table 36: Existing Parameter – Refrigeration Systems	82
Table 37: Cost Benefit Analysis – Evaporative Condenser	83
Table 38: Vendor Details – Evaporative Condenser.....	85

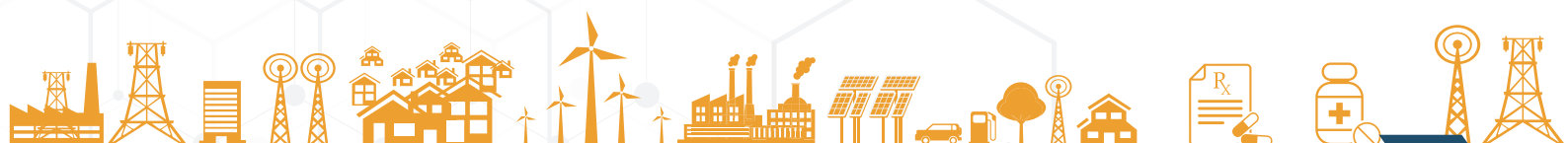
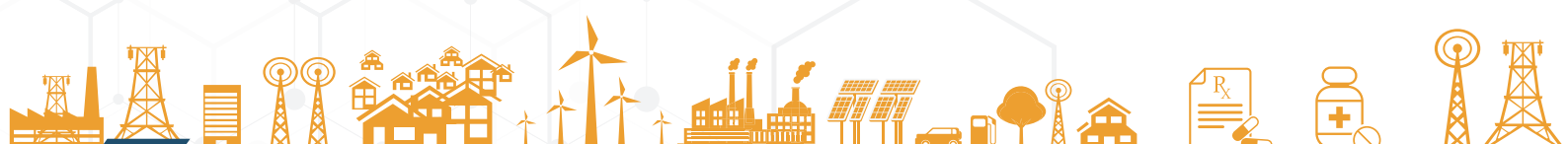
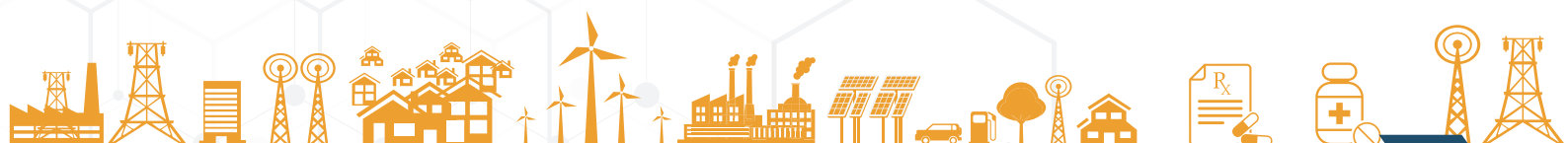

Table 39: Cost benefit analysis: EC fans for AHUs.....	87
Table 40: Reference plant implementation - EC blowers for AHUs	88
Table 41: Vendor Details – EC fans.....	89
Table 42: Cost Benefit Analysis – Online condenser cleaning system.....	91
Table 43: Reference plant implementation - Online Condenser Tube Cleaning System	92
Table 44: Vendor Details – Online Condenser Cleaning System	93
Table 45: Cost benefit analysis - Two port system for AHUs.....	95
Table 46: Vendor Details – VFD for Chilled water pump	96
Table 47: Cost benefit analysis - Active refrigerant agent.....	99
Table 48: Vendor Details – Active refrigerant agent	99
Table 49: Cost benefit analysis – Optimize chilled water pumping system	102
Table 50: Vendor Details – Optimizing pumping system	103
Table 51: Plant compressor loading pattern	104
Table 52: Cost Benefit Analysis - VFD for Air Compressor	105
Table 53: Vendor Details – VFD for Air Compressor	106
Table 54: Cost Benefit Analysis – Energy Efficient Pump	108
Table 55: Vendor Details – Energy Efficient Pumps	109
Table 56: Cost Benefit Analysis – IOT Based Water Management System.....	111
Table 57: Reference Plant Implementation – IOT based water management system.....	112
Table 58: Vendor Details – IOT Based Water Management System	113
Table 59: Performance of HP compressor.....	114
Table 60: Cost Benefit Analysis – Energy Efficient LP Compressor	115
Table 61: Vendor Details – LP Compressor	116
Table 62: Site Specification – For Solar PV.....	117
Table 63: Features/requirements for Grid Connected Solar PV Systems (Rooftop).....	118
Table 64: Cost Benefit Analysis – Solar PV Systems.....	120
Table 65: Vendor Details – Solar PV.....	120
Table 66: Cost Benefit Analysis – Solar Wind Hybrid Systems	123
Table 67: Vendor Details – Solar-Wind Hybrid Systems.....	124



List of Abbreviations

AC	Alternating Current
AHU	Air Handling Unit
APFC	Automatic Power Factor Controller
API	Active Pharmaceutical Ingredient
BEE	Bureau of Energy Efficiency
BEP	Best Efficiency Point
BLDC	Brushless Direct Current
CAGR	Compound Annual Growth Rate
CHW	Chilled Water
CII	Confederation of Indian Industry
COP	Coefficient of Performance
CT	Cooling Tower
CUF	Capacity Utilisation Factor
DC	Direct Current
DG	Diesel Generator
DPCO	Drug Price Control Orders
DPR	Detailed Project Report
EC	Electronically Commutated
ETP	Effluent Treatment Plant
FCU	Fan Coil Unit
GCRT	Grid connected Roof top
GCV	Gross Calorific Value
GDP	Gross Domestic Product
GEF	Global Environmental Facility
GHG	Greenhouse Gas
GI	Galvanized Iron
HSD	High Speed Diesel
HVAC	Heating Ventilation and Air Conditioning



ID	Induced Draft
IIoT	Industrial Internet of Things
INR	Indian Rupee
IoT	Internet of Things
IRR	Internal Rate of Return
ISO	International Standards Organization
LED	Light Emitting Diode
LP	Low Pressure
LSP	Local Service Provider
MNRE	Ministry of New and Renewable Energy
MPPT	Maximum Power Point Tracker
MS	Mild Steel
MSME	Micro, Small and Medium Enterprises
NB	Nominal Bore
NPV	Net Present Value
O&M	Operation and Maintenance
OEM	Original Equipment Manufacturer
PCU	Power Conditioning Unit
PF	Power Factor
PHE	Plate Heat Exchanger
PID	Proportional Integral Derivative
PLC	Programmable Logic Controller
PMU	Project Management Unit
PRV	Pressure Reducing Valve
PV	Photovoltaic
RE	Renewable Energy
RTD	Resistance Temperature Detector
SEC	Specific Energy Consumption
SOPT	Steam Operated Pumping Trap
TCV	Temperature Control Valve
TDS	Total Dissolved Solids

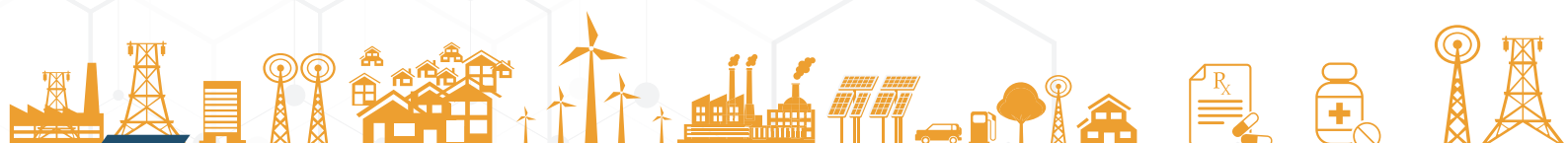

TOE	Tons of Oil Equivalent
UAC	Unit Abatement Cost
UNIDO	United Nations Industrial Development Organization
UOM	Unit of Measurement
VAM	Vapour Absorption Machine
VFD	Variable Frequency Drive
WHR	Waste Heat Recovery

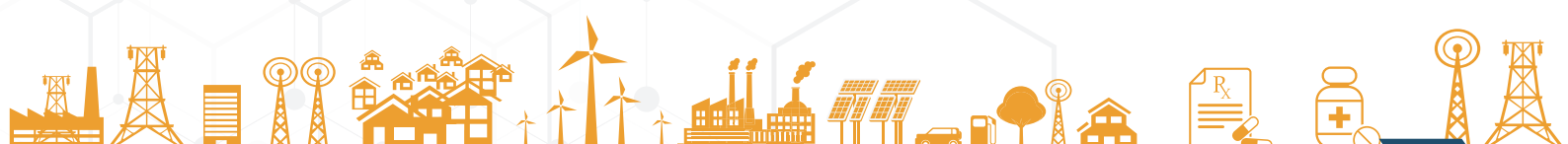

Unit of Measurements

CFM	Cubic Feet per Minute
gm	Grams
Hp	Horse Power
kg	Kilogram
kg/cm ²	Kilogram per centimeter square area
kJ	Kilo Joule
kl	Kilo Litre
kl/hr	Kilo Litre per Hour
km	Kilometre
kVAr	Reactive Power
kW	Kilo Watt
kWh	Kilo Watt Hour
kWp	Kilowatt Peak
°C	Degree Celsius
ppm	parts per million
Psi	Pounds per Square Inch
INR	Rupees
TCO ₂	Tons of Carbon dioxide
TDS	Total Dissolved Solids
THD	Total Harmonic Distortion
TOE	Tons of Oil Equivalent
TPD	Tons Per Day
TPH	Tons per Hour
TR	Tons of Refrigeration

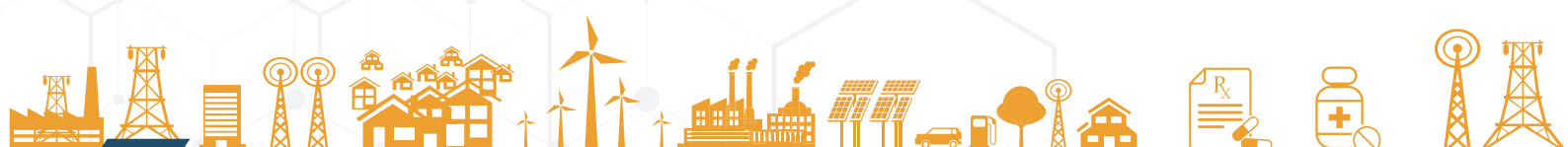

This Page Intentionally Left Blank

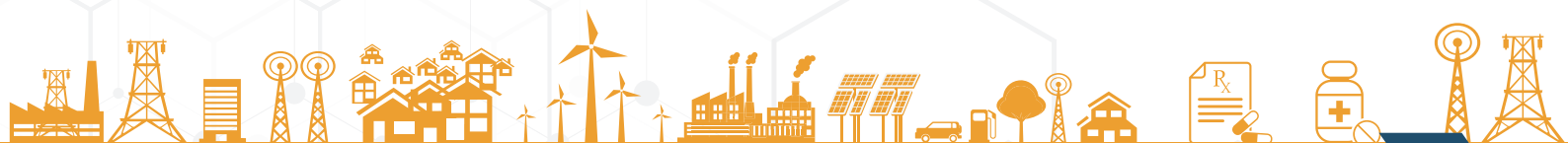



About Project & Technology Compendium

About the Project

The United Nations Industrial Development Organization (UNIDO), in collaboration with the Bureau of Energy Efficiency (BEE), a statutory body under the Ministry of Power, Government of India, is executing a Global Environment Facility (GEF) funded national project titled 'Promoting energy efficiency and renewable energy in selected MSME clusters in India'. The project was operational in 12 MSME clusters across India in five sectors, respectively: Brass (Jamnagar); Ceramics (Khurja, Thangadh and Morbi); Dairy (Gujarat, Sikkim and Kerala); Foundry (Belgaum, Coimbatore and Indore); Hand Tools (Jalandhar and Nagaur). The Project has now scaled-up and expanded its activities to 11 new clusters, namely in Dairy (Tamil Nadu, Odisha, Madhya Pradesh, Andhra Pradesh & Telangana, Haryana, Maharashtra & Punjab), Foundry (Ahmedabad & Howrah), Ceramic (Himmatnagar) Mixed Cluster (Indore & Sikkim) in order to reach out to MSME's at national level.

This project so far has supported 303 MSME units in implementing 603 Energy conservation Measures and thus resulted in reduction of about 10,850 TOE energy consumption and avoided 62,868 metric tons of CO₂ emissions as on date.

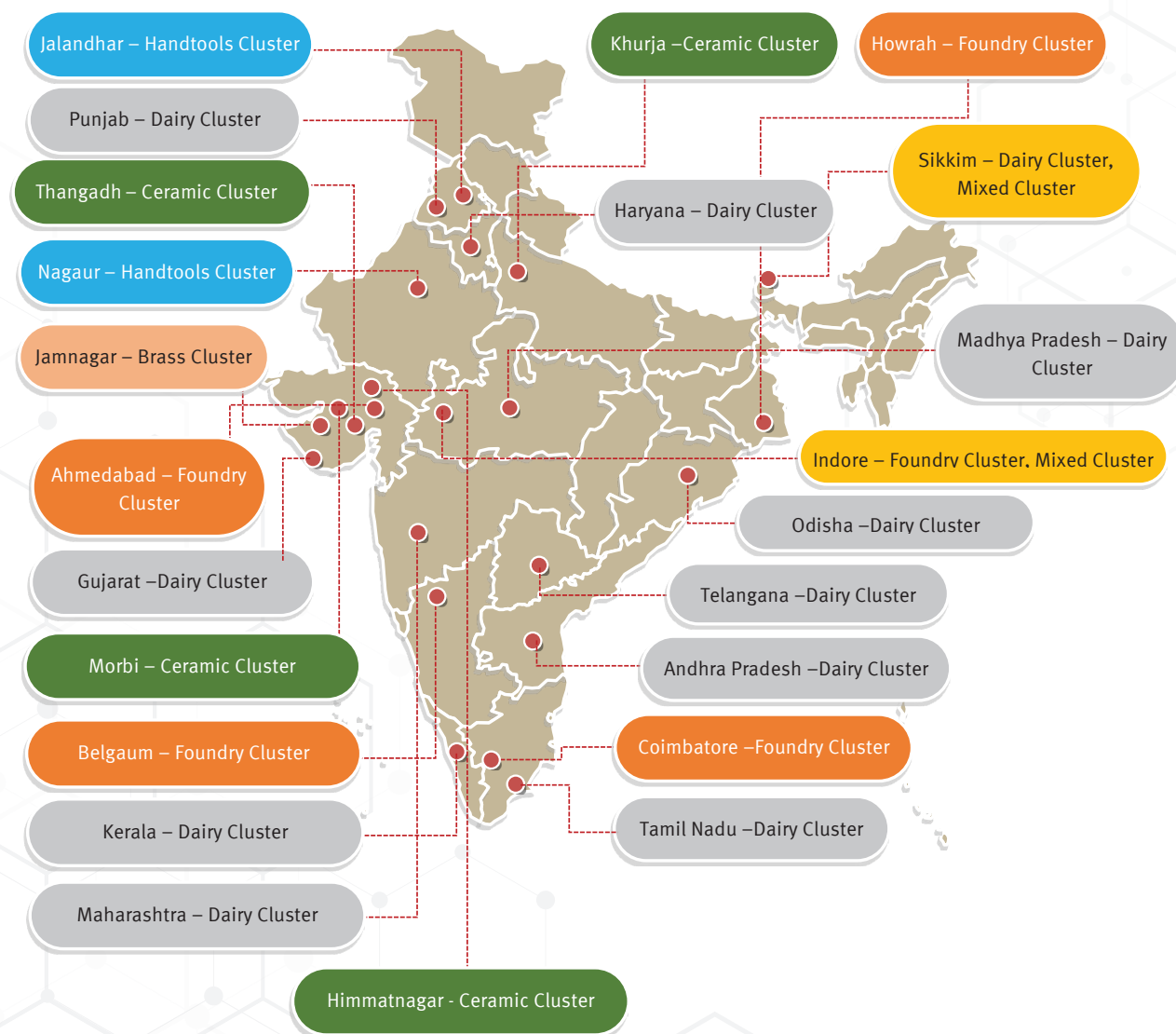

The key components of the project include:

- ❖ Increasing capacity of suppliers of EE/RE product suppliers / service providers / finance providers
- ❖ Increasing the level of end user demand and implementation of EE and RE technologies and practices by MSMEs.
- ❖ Scaling up of the project to more clusters across India.
- ❖ Strengthening policy, institutional and decision-making frameworks.
- ❖ Significant progress has been made in the project and it is now proposed to scale up and expand. The activities envisaged under the scaling up phase of the project include:
 - ✧ Establishment of field level Project Management Cell (PMC)
 - ✧ Organizing cluster level awareness program and identification of potential MSME enterprises
 - ✧ Development of cluster specific EE and RE based technology compendiums
 - ✧ Providing implementation support and other related activities to the identified enterprises

About the Technology Compendium

The industries in India today face challenges and opportunities resulting from rising energy costs, environmental concerns and competitiveness. The pharma industries use energy for cooling, heating, and in operation of various equipment such as refrigeration, boilers, compressors, etc. Over the years, there has been significant technology improvement in process and utilities areas, and industries have been able to improve the energy efficiency in their operations. However, various opportunities in improving energy efficiency are yet to be exploited. To be competitive and have environment-friendly operations, energy efficiency is crucial.

The technology compendium is prepared with the objective of accelerating the adoption of energy efficient technologies and practices in pharma units and it focuses on equipment upgrades, new technologies, and practices for improving energy efficiency. The technology case studies included in the compendium provide all the necessary information to enable units to refer and implement them in their operations. The case studies are supported by technology background, baseline scenario, merits, challenges, technical feasibility, financial feasibility, and technology provider details. The energy efficiency measures included in the report cover more than 90% of energy consumption in a typical pharma unit.

- ❖ The objective of this compendium is to act as a catalyst to facilitate industries towards continuously improving their energy performance, thereby achieving world class levels (with a thrust on energy & environment management).
- ❖ The compendium includes general energy efficiency options as well as specific case studies on applicable technology upgradation projects which can result in significant energy efficiency improvements.
- ❖ The suggested best practices may be considered for implementation only after detailed evaluation and fine-tuning requirements of existing units.
- ❖ In the wide spectrum of technologies and equipment applicable for pharma sector in Sikkim for energy efficiency, it is difficult to include all the energy conservation aspects in this manual. However, an attempt has been made to include the more common implementable technologies across all the units.
- ❖ The user of the compendium has to fine-tune the energy efficiency measures suggested in the compendium to their specific plant requirements, to achieve maximum benefits.
- ❖ The technologies collated in the compendium may not necessarily be the ultimate solution as the energy efficiency through technology upgradation is a continuous process and will eventually move towards better efficiency with advancement in technology.
- ❖ The Sikkim pharma cluster should therefore view this manual positively and utilise this opportunity to implement the best operating practices and energy saving ideas during design and operations, to facilitate achieving world class energy efficiency standards.

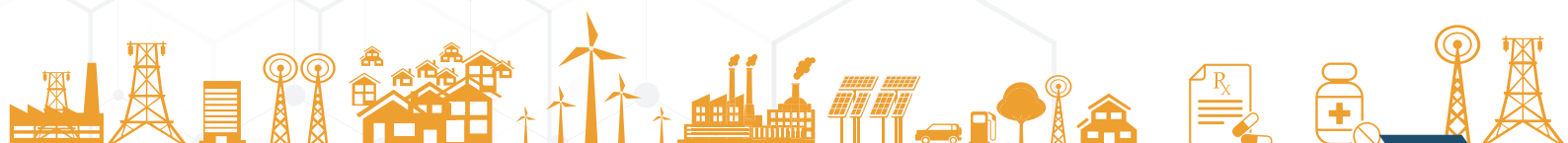



Executive Summary

Executive Summary

The United Nations Industrial Development Organization (UNIDO), in collaboration with the Bureau of Energy Efficiency (BEE), a statutory body under the Ministry of Power, Government of India, is executing a Global Environment Facility (GEF) funded national project called ‘Promoting energy efficiency and renewable energy in selected MSME clusters in India’. The project execution is planned in multiple phases.

The aim of the Phase-I of the project was to develop and promote a market environment for introducing energy efficiency and enhanced use of renewable energy technologies in process applications in the above mentioned (12) selected energy-intensive MSME clusters in India, with feasibility for expansion to more clusters. Phase-II of the project is to scale up and expand the project activities to a greater number of enterprises in existing clusters, as well as 11 new clusters, for better implementation of energy efficiency technologies and practices.

Efficient use of energy in any facility is invariably the most important strategic area for manageability of cost or potential cost savings. Awareness of the personnel, especially of operators in the facility, becomes a significant factor for proper implementation of energy conservation initiatives. With this context, this Technology Compendium has been prepared, comprising various technologies and best practices to save energy.

The information in this compendium is intended to help the energy managers in the Sikkim cluster reduce energy consumption in a cost-effective manner while maintaining the quality of products manufactured. Further analysis on the economics of all measures — as well as on their applicability to different production practices — is needed to assess their cost effectiveness at individual units. Additionally, this compendium shall also serve the purpose of tapping the opportunities to significantly reduce energy consumption. Further, this shall also serve as a guide for estimating the feasibility of energy saving projects at the first place and ensure accelerated implementation.

Chapter 1 of the compendium provides an overview of Sikkim Pharma Cluster.

Chapter 2 focuses on a brief overview of pharma process and energy consumption in pharma units, and includes technology status/mapping of the cluster.

Chapter 3 focuses on the importance of energy efficiency in units, and some of the common measures applicable to different sections of the unit. The energy efficiency measures are included for more than 90% of energy consumption areas in a plant, such as refrigeration, steam systems, process, utilities, and utilization of renewable energy. The chapter also includes some of the best practices and key indicators that the plant should follow and monitor to maintain the energy efficiency levels in different energy consuming areas.

Chapter 4 provides detailed case studies for some of high impact and implementable energy efficient technologies in pharma units. In this chapter, 20 case studies have been included in areas such as refrigeration, steam systems, utilities, renewable energy, etc. These technologies are described in detail, such as baseline scenario, proposed scenario, merits, demerits,

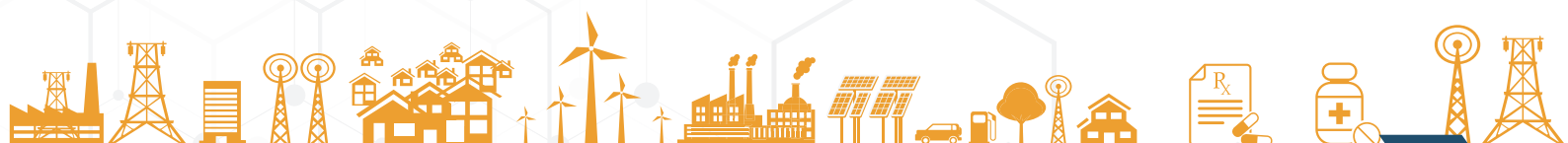

etc., and wherever possible, a case reference from a pharma unit that has implemented the technology has been included. In most of the examples, typical energy saving data, GHG emission reduction, investments, payback period, etc., have been highlighted. Energy saving potential in this sector is estimated to be about 10-15% without (or with marginal) investment, and an additional 15% with investment. High potential for improving energy efficiency in pharma units exists in the areas of heating and cooling via adoption of technologies such as co-generation, de-super heater, evaporative cooling systems, utilization of renewable energy, biomass fired boilers, and increased automation.

The following table summarizes a list of technologies included in the compendium:

Table 1: Energy Efficiency Technologies – Attractiveness and Investment

S. No.	Sikkim Cluster	IRR (%)	Payback period (Months)	Investment (INR lakh) /TOE
1	Conversion of HSD-fired Boiler to Biomass-fired Boiler	169.2	9.0	-
2	Condensate Recovery System	319.5	4.0	0.3
3	Steam Operated Pumping Traps	284.9	30.0	0.3
4	Steam Driven Heat Pump	271.0	5.0	0.3
5	VFD in Reciprocating Chiller Compressor	73.0	23.0	1.2
6	Waste Heat Recovery from Chiller Compressor	116.5	13.0	0.8
7	kVAr Energy Compensator for Chiller Compressor	83.6	20.0	1.1
8	VFD for chilled water pumps	4.6	6.0	0.2
9	Evaporative Condenser	63.8	27.0	1.7
10	Electronically Commutated motors for AHUs	87.6	18.0	1.1
11	Online Condenser Cleaning System	50.5	35.0	2.2
12	Replace three port valves with two-part valves for AHUs and install VFD for chilled water pump	81.7	24.0	1.2
13	Active refrigerant agent addition in lube oil for chillers	163.8	9.0	0.5
14	Optimize chilled water pumping system	48.5	8.0	0.8
15	VFD for air Compressor	142.0	11.0	0.6
16	Energy Efficient Pumps	66.7	17.0	0.6
17	IoT based Water Management System	181.1	8.0	-
18	Replacement of plant HP compressor with LP compressor	50.7	35.0	2.2
19	Solar rooftop system	19.8	57.0	3.6
20	Solar-Wind Hybrid system	20.9	63.0	4.8

The Sikkim Pharma cluster should view this manual positively and utilise this opportunity to implement the best operating practices and energy saving ideas during design and operations stages, and thus work towards achieving world class energy efficiency.

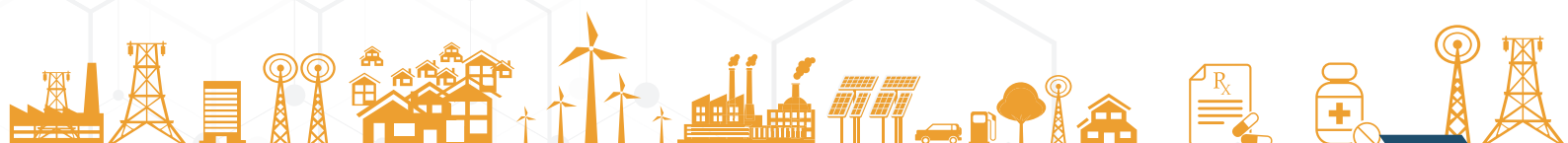



1. Indian Pharmaceutical Sector

1. Indian Pharmaceutical Sector

1.1 Background

The Indian pharmaceutical sector is estimated to account for 3.1 – 3.6%* of the global pharmaceutical industry in value terms, and 10% in volume terms. The country's pharmaceutical industry is expected to expand at a CAGR of 12.89% 2015–20 to reach US \$ 55 billion in India. India is the second largest contributor of global biotech and pharmaceutical workforce. The composition of the Indian pharmaceutical companies consists of a 70% share (in terms of revenue) in generic drugs. Over the counter medicines and patented drugs constitute 21% and 9% respectively. India shares 1.5% of the global pharmaceutical industry by value, and 20% by volume.¹

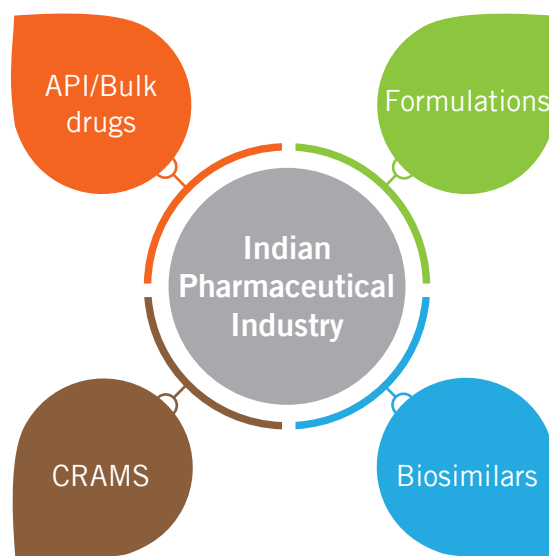
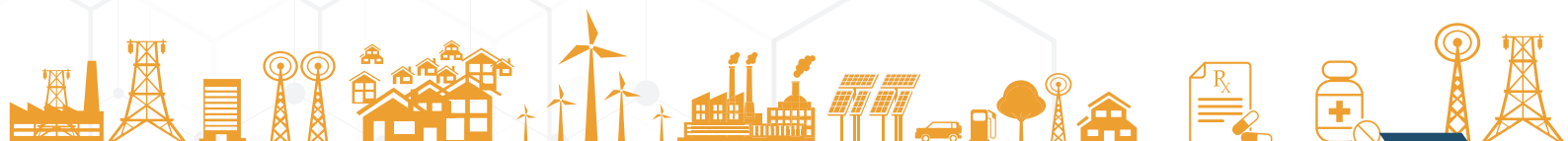

Figure 1: Breakup of the Indian Pharma sector

Anti-infective drugs command the largest share, accounting for 16% of the Indian pharma market. The Department of Pharmaceuticals and the National Pharmaceutical Pricing Authority are the major stakeholders in the sector. The structure of the Indian pharmaceutical sector is shown below:

¹ KPMG – The US India dynamic prospering together; June 2018



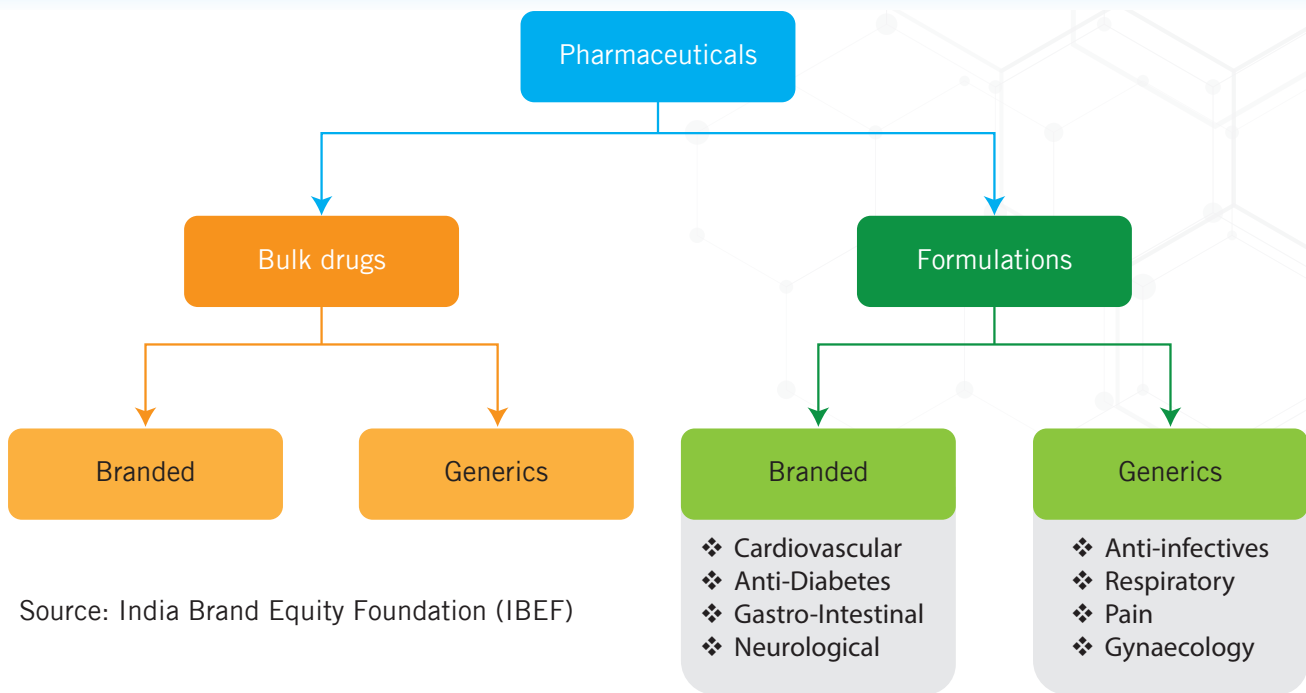

Figure 2: Structure of Indian Pharmaceutical sector

1.2 Pharma Sector Growth and Revenue

The revenue of the Indian pharmaceutical sector is segregated into non-scheduled formulations and scheduled formulations. The Drug Price Control Orders (DPCO) issued by the Government fixes the ceiling price for essential and lifesaving drugs. Price control is applicable to 'scheduled formulations', since some of the bulk drugs when used as single ingredient also act as a formulation. These scheduled formulations are declared in the list of 'National List of Essential medicines'. The revenue from Scheduled and Non-scheduled formulations in 2017 is shown below:

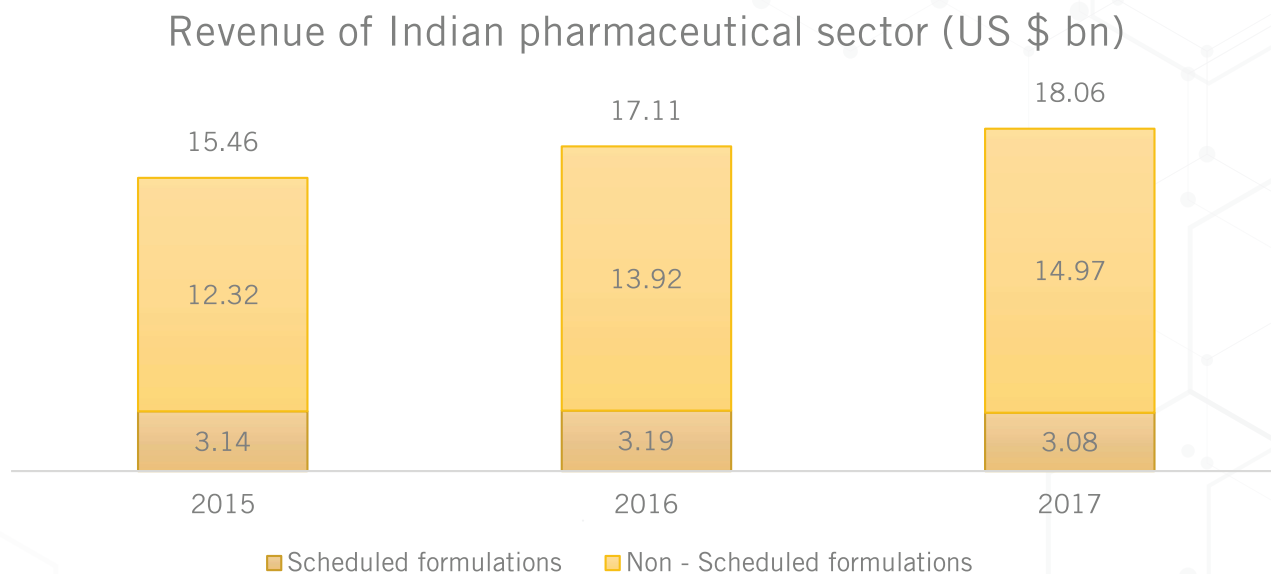

Figure 3: Scheduled and Non-Scheduled formulations in India

India is the largest provider of generic drugs globally. The Indian pharmaceutical industry caters to 50% of the global demand for various vaccines, 40% of generic drugs in the US, and 25% of all medicines in the UK. The pharmaceutical sector was valued at USD 33 billion in 2017. The pharmaceutical sector is expected to grow at a rapid pace of 22.4% over 2015-20, to reach USD 55 billion.

India's domestic pharmaceutical market turnover reached INR 129,015 crore (USD 18.12 billion) in 2018, growing 9.4% year-on-year from INR 116,389 crore (USD 17.87 billion) in 2017. Indian companies received 304 Abbreviated New Drug Application (ANDA) approvals from the US Food and Drug Administration (USFDA) in 2017. The country accounts for around 30% of volume and about 10% of value in the USD 70-80 billion US generics market.

India's biotechnology industry, comprising bio-pharmaceuticals, bio-services, bio-agriculture, bio-industry and bioinformatics is expected to grow at an average growth rate of around 30% a year, and reach USD 100 billion by 2025².

² <https://www.ibef.org/industry/pharmaceutical-india.aspx>

The pharmaceutical sector is a wide sector and consists of several plants in drug manufacturing or on active pharmaceutical ingredients. The major players in the sector, with reference to their revenue, are shown below:

Table 2: Major players in Pharmaceutical sector

Company	Revenue in 2016 (USD million)
Sun Pharma	4,240
Dr. Reddy's Laboratories	2,350
Lupin	2,093
Biocon	639.05

The market size of the pharmaceutical industry, including exports, is shown in the chart below. With high market potential, the share of exports is also approximately 50%.

Market size and exports from India (US \$ Billion)

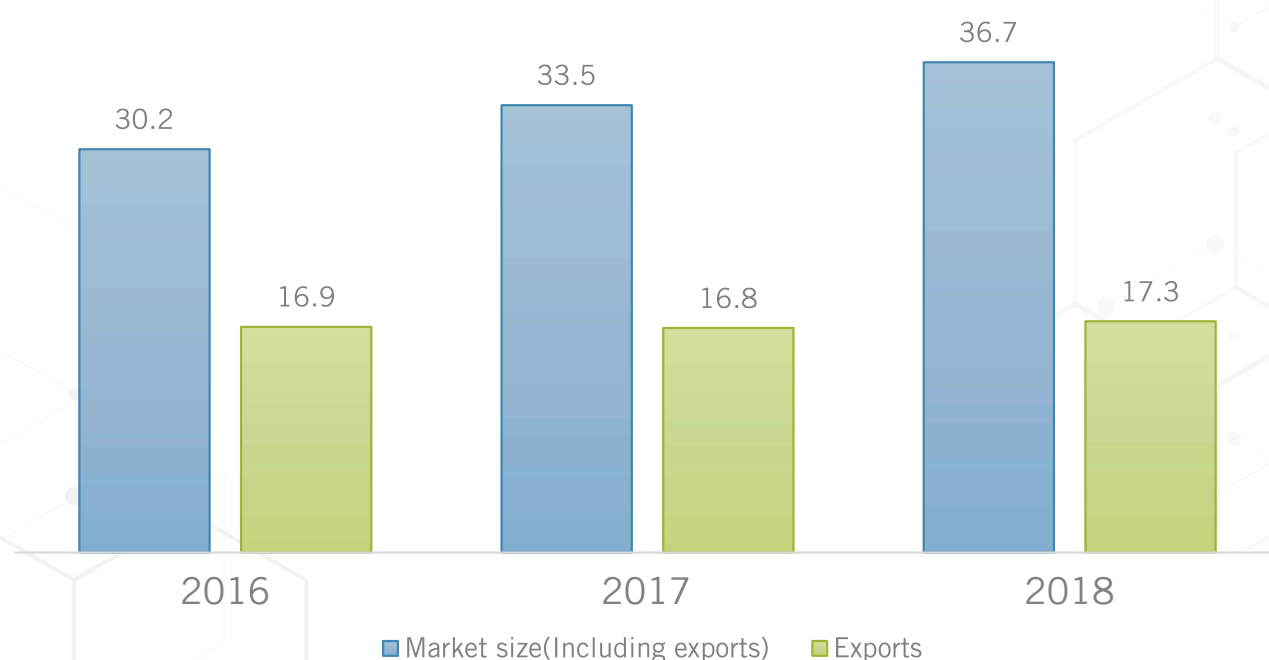

Figure 4: Market size and exports from India

1.3 Sikkim Industrial Cluster

Sikkim industrial cluster is one of the growing sector in India, heavily dependent on Central Government grants. It needs to undertake an all-around development effort to come at par with the other states of the country. The units that are engaged in the manufacturing sector here are mainly dealing with pharmaceuticals, chemicals, liquors, foam mattresses, food products, iron rods, etc.

Sikkim has identified agro-based industries, horticulture & floriculture, minor forest-based industries, animal husbandry & dairy products, tourism-related industries, IT including knowledge-based industries, precision oriented high value-low volume products, hydro-power, tea, education and hospitality as thrust sectors. The state government of Sikkim has embarked upon the rapid industrialization of the state. It has enacted a number of policy measures to assist the investors in setting up industries in Sikkim. These measures include, among others, investment subsidy on total investment; subsidy on captive power generating sets; special incentive to the pioneer unit; special incentives for women entrepreneurs; stipendiary support for EDP; allotment of land; subsidy on state transport; power subsidy, etc. Ministry of Commerce and Industry, Department of Industrial Policy and Promotion, Govt. of India, has approved a package of fiscal incentives and other concessions for the North East Region which include among others excise duty exemption; income tax exemption; capital investment subsidy; interest subsidy; comprehensive insurance; incentives for service/ other sector industries; incentives for bio-technology industry; incentives for power generating industries; transport subsidy, etc.

Pharmaceutical is an emerging industry in Sikkim due to tax incentives offered by the state government as well as low manufacturing and labour costs. Sikkim is home to 14 major pharma companies, which have significant investments in the state. These include Cipla, Sun Pharma, Zydus Cadila, Alembic, IPCA, Alkem Lab, Intas Pharma, Torrent Pharma, and Unichem. Sikkim is the only state which offers excise benefits and major players of the pharmaceutical industry have set up their manufacturing units in the state. The North-East Industrial and Investment Promotion Policy, 2007, and the pollution-free atmosphere are highly beneficial for pharma investments in Sikkim. Some key policy incentives are:

- ❖ 100% excise duty exemption on finished products.
- ❖ 100% income tax exemption.
- ❖ 30% capital investment subsidy on investments in plant and machinery.

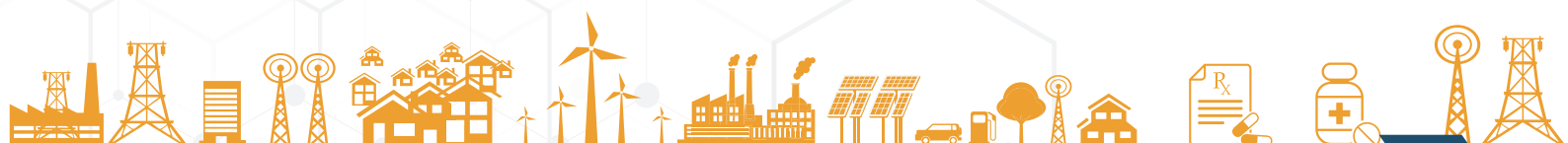

A close-up photograph of a female scientist in a white lab coat and safety glasses, wearing blue nitrile gloves. She is focused on her work, using a pipette to transfer liquid into a multi-well plate. The background is a blurred laboratory environment with various pieces of equipment. The entire image has a blue color overlay.

2. Energy Consumption Pattern

2. Energy Consumption Pattern

2.1 Energy Consumption

The pharma industry uses energy in the form of steam, hot water, and electricity for process applications. The cost of energy sources used in the industry is increasing continuously, which in turn increases the processing expenses and, therefore, the product cost. Energy costs typically constitute 10%-20% of the overall manufacturing cost.

Energy consumption of different processing plants varies widely, depending on capacity utilization, availability of raw materials, scale of the plant, technology used, level of automation and product mix. The share of fuel cost (thermal and electrical) in a typical pharma in Sikkim is depicted in Figure 5 and is primarily dominated by thermal energy as all the units are using HSD as the fuel for boilers/hot water generators.

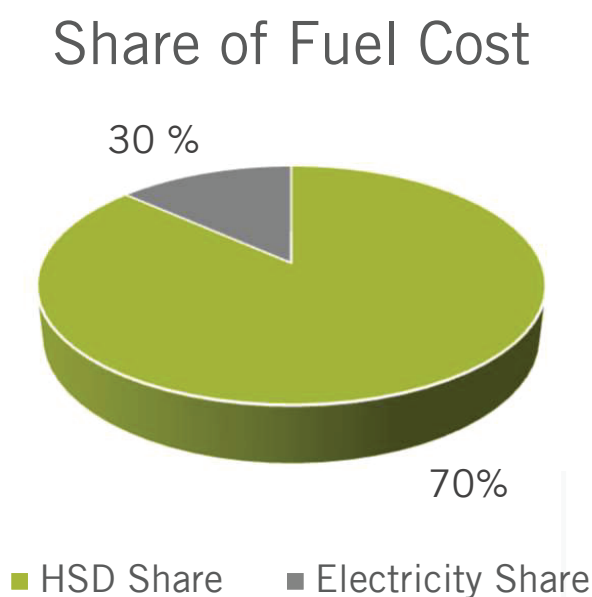
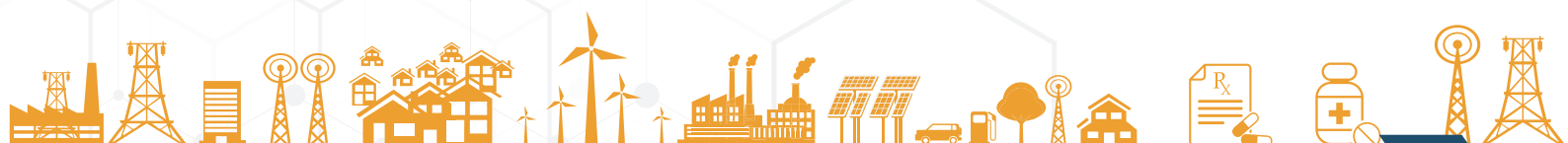

Figure 5: Energy Cost – Breakup

The major portion of energy consumption in a typical pharma goes to refrigeration, general utility, and services, which include heating and steam generation. A certain portion of energy consumption goes to the cleaning operation and the processing activity. The major energy consuming equipment includes refrigeration system, air compressors, lightings, pumps, motors, condensers, separator and clarifiers, effluent treatment plant, and boilers.

Pharma units in India have seen significant improvement in energy and productivity in the last few years due to increased levels of automation and technology development. This has helped in improving product quality and operating conditions while reducing product losses, maintenance time, manpower requirement and energy consumption. Innovations like building designs now provide more natural light coupled with a natural ventilation system, which has led to conservation of energy as well as improvements in operating conditions.



2.2 Pharma Sector – Manufacturing Process

The process of manufacturing pharmaceutical drugs consists of milling, drying, compression, and coating. Drug products consist of therapeutics and excipients combined in a delivery system. These processes are briefly explained as follow:

Blending

Blending process includes blending of API and numerous excipients which include fillers, binders, lubricants or disintegrates. Blending is a process to ensure homogeneous mixture of all ingredients.

Crystallization

Crystallization is a major technology process for particle formation and plays a vital role in defining stability and drug release properties of the final dosage forms. Crystallization is a technique to purify solids. Crystallization is based on solubility. The solubility of solid crystals is high in hot solution in comparison to cold solutes. When a saturated solution of solid is cooled, the solute is no longer solid and crystals of the solute are formed. Impurities are then separated by filtration process.

Milling

Milling is required in the process to reduce the average particle size of drug form. Reasons for milling are to maintain homogeneity and dosage uniformity, increasing bioavailability and increasing the solubility of the drug compound.

Granulation

Granulation is a process that can be described as the opposite of milling. Granulation, in short, produces granules from powdered particles to produce larger granules. Granulation process is followed as wet granulation or dry granulation based on APIs used.

Drying

Drying is carried out to remove moisture. Two processes are used: Non-thermal or thermal drying. Non-thermal drying is carried out by squeezing through wetted sponge, adsorption by desiccant or extraction. Drying is carried out to:

- ❖ Avoid or eliminate moisture, which may lead to corrosion and decrease in drug stability
- ❖ Improve or keep the good properties of a material such as flowability or compressibility
- ❖ Reduce cost of transportation of large volume of materials
- ❖ Make the material easy to handle
- ❖ Help in preservation
- ❖ Be the final step in evaporation, filtration, and crystallisation

Compression

Tablets are formed by compressing granules. The tablet is passed between upper and lower compression punches. The schematic of a compression system is shown in the figure below:

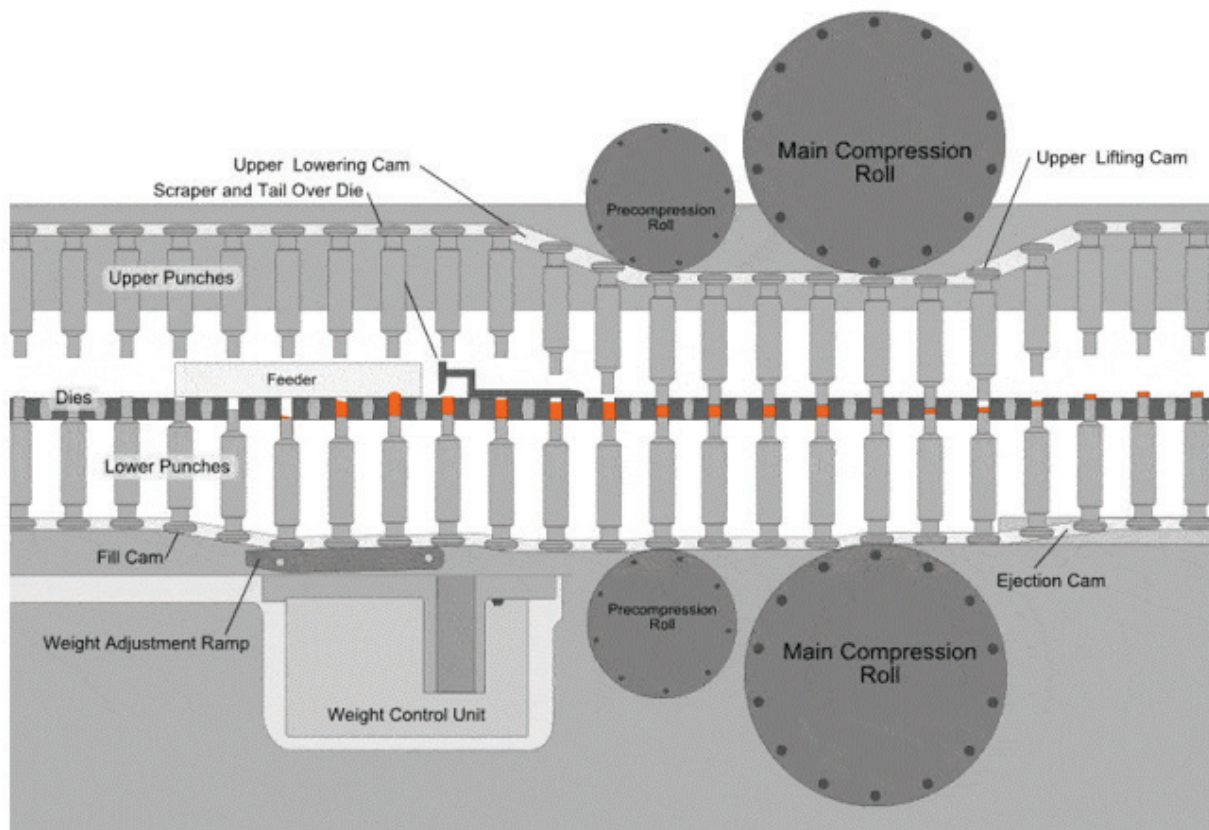

Figure 6: Tablet compression

Coating

Tablet coating is a process in which a dry outer coating is given to the tablet material in order to confer specific benefits over uncoated tablets. Tablet coating may be implemented to mask the odour, mask the taste, physical and chemical protection or control the release profile of the tablet. Several different types of coating such as sugar coating, film coating, organic film coating or aqueous film coating. The equipment which may be used are Electrostatic coating, corona coating, tribo charging, magnetic assisted impact coating, vacuum fill coating, compression coating or dip coating.

2.3 Technology Status in Sikkim Cluster

The manufacturing sector in Sikkim is home to 14 major pharma companies, which have significant investments in the state. They have expanded over time with upgradation of equipment and technologies, expansion, automation, and process control. Following is the technology status for the units in Sikkim:

Table 4: Technology Status – Sikkim Cluster

S. No.	Area	Current Status
1	Energy Sources	<p>Electrical and thermal energy are the major energy consumers of pharma units.</p> <p>Electrical Energy – The units procure electricity from Sikkim Power Department and pay in the range of INR 6/kWh.</p> <p>For thermal energy, it is mostly met through liquid fuel. The unit procures fuel from supplier is made available for the units to use for their requirement in boilers. The main fuel used in Sikkim is High Speed Diesel Oil; however, some units are gradually moving towards solid fuel fired boilers where briquette is used as the fuel.</p>
2	Steam Generation	<p>The units in Sikkim use boilers for meeting their steam requirement. It is generated in range of 8-10 kg/cm² in the plants and is used in various processes, such as FBD, AHU, and Coater Machines.</p>
3	Steam Distribution	<p>On the steam distribution side, the units reduce the pressure of steam through Pressure Reducing Valve (PRV) and send it to various process/section for use. On the condensate recovery, not many units have the systems in place for maximum recovery and this is still a large potential area to be targeted. In addition to that, the steam trap monitoring and maintenance is also an important area for pharma units to focus on. However, not all the units use efficiency monitoring systems or waste heat recovery, and this presents a good opportunity for upgradation.</p>
4	Refrigeration Compressors	<p>The refrigeration system is a critical area for any pharma unit, as faster and appropriate cooling is a necessity. Most of the units are using screw or centrifugal chillers. There is a good potential for technology upgradation in the cluster by putting evaporative condensers, online tube cleaning system, automation, etc.</p>
5	Renewable Energy	<p>A few of the units in Sikkim have utilized the option of renewable energy for electrical and thermal energy. Some units have installed rooftop systems (kW scale), but there's good potential for Solar Photo-voltaic (PV) installation in various other pharma units. Some units have also installed Solar Thermal Systems for boiler feed water heating or hot water for cleaning.</p>
6	Others	<p>The other equipment and technologies are Pumping, electrical distribution, compressed air systems, etc.</p>

S. No.	Area	Current Status
6a	Pumping	The pumping systems are used extensively units in Sikkim. The efficiency of these pump sets needs to be evaluated, as some pumps are old and when expansion is undertaken, new pump sets are installed, but often there is good scope for improvement by avoiding throttling (installation of VFD, trimming of impeller) or installation of high efficiency pump sets (more than 60% efficiency).
6b	Electrical Distribution	Power Factor: Most of the units have installed Automatic Power Factor Controller (APFC) for power factor improvement. For harmonics control, the units have also installed harmonic filters. However, there are certain opportunities which units can tap in electrical distribution, such as industries installation of energy efficient transformers, optimal loading of transformers, installation of energy efficient motors, installation of VFD, soft starters, auto star delta conversion, etc.
6c	Compressed Air	Compressed air in pharma units is used as instrument air and in packing machines. Most of the units have converted their old reciprocating compressors to screw air compressors to meet their compressed air requirements.

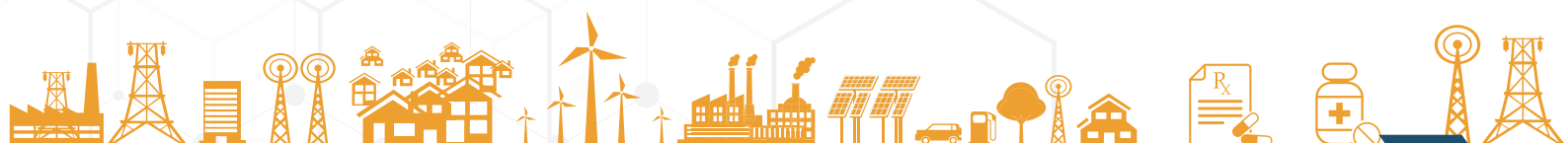



3. Energy Efficiency Opportunities

3. Energy Efficiency Opportunities

3.1 Energy Efficiency in Sikkim Pharma Cluster

The refrigeration and steam systems are necessary and energy consuming for any pharma unit, and improving energy efficiency in these areas are critical. Over the years, there has been significant technology improvement in process and utilities areas, and units have been able to improve energy efficiency in their operations. However, opportunities still exist for units to improve their energy efficiency and to become more competitive. For environment friendly operation, energy efficiency is indispensable.

The units have been implementing various energy conservation measures across various production processes. Energy efficiency at an industry can be viewed at two levels – equipment & component level, and process level. The energy efficiency at equipment or component level can be achieved by adopting various new technologies, preventive maintenance, optimum utilization, or replacement of old equipment with new and energy efficiency equipment. In addition to improving energy efficiency at equipment or component level, the industrial sector in India has made significant improvements in process level efficiency through various energy conservation measures such as automation, process control & optimization, process integration or implementation of new and efficient processes.

Often, energy efficiency measures when implemented at the unit operations not only result in improvement in energy efficiency but also in productivity and quality. To summarize, the energy efficiency strategy for this industry can be focused at three levels:

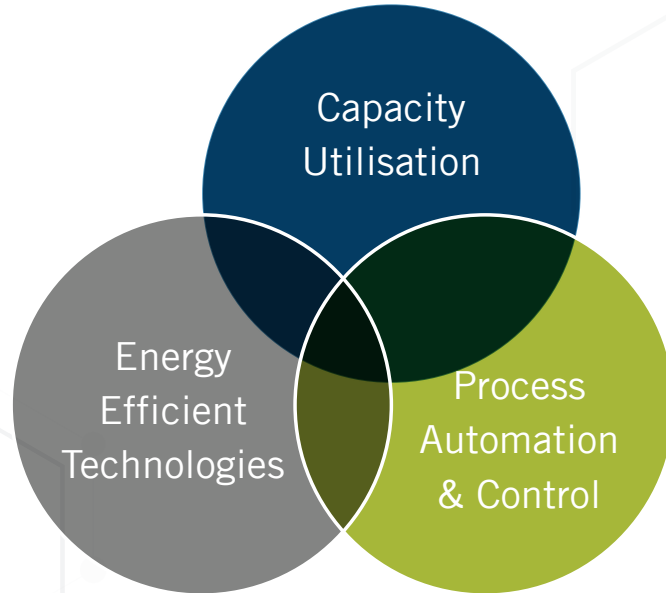
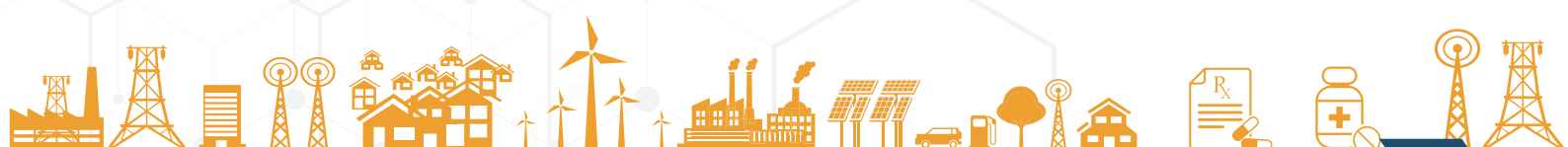

Figure 7: Energy Efficiency Approach



3.2 Energy Efficiency Measures

There are various energy consuming areas within a plant which can be classified as primary energy consuming areas, such as steam systems and the refrigeration plant. The following figure provides an overview of energy usage in a typical plant:

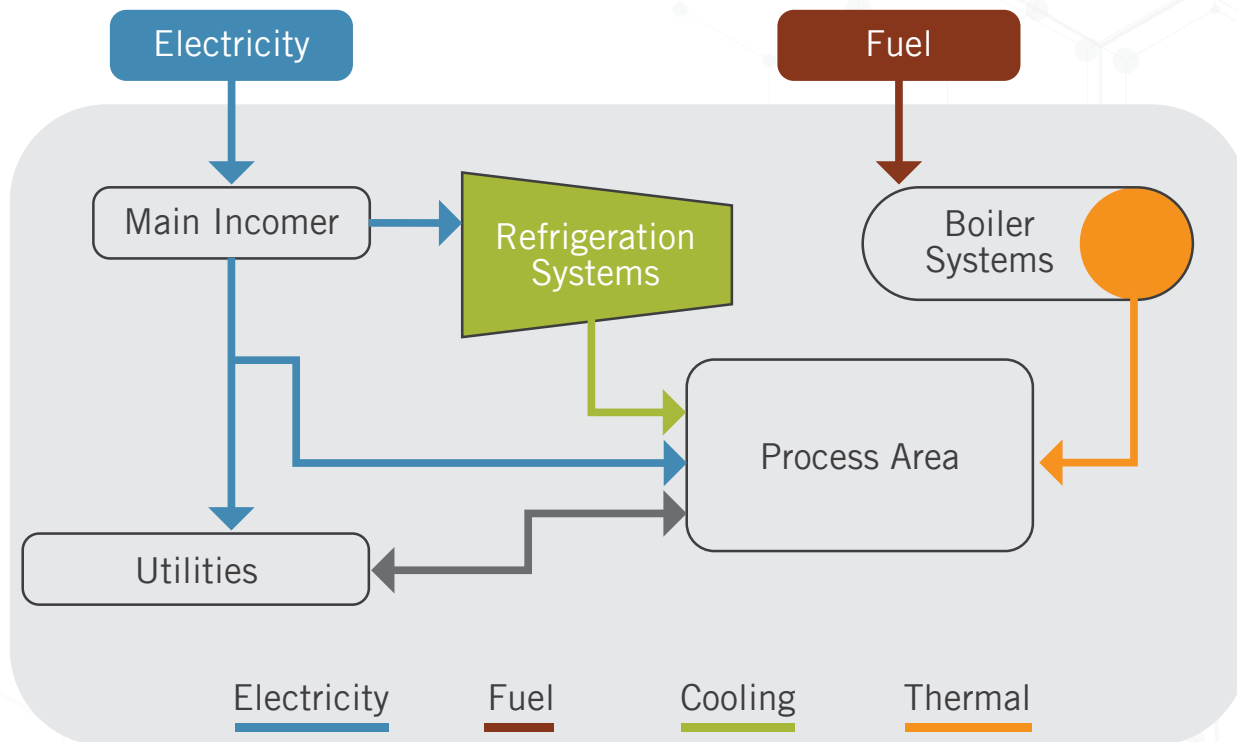

Figure 8: Energy Consumption Overview

- The following section provides an overview of some of the key energy efficiency measures in major energy consuming areas in a unit. In further sections, some of the latest applicable technologies are covered.

3.2.1 Energy Efficiency in Steam Systems

The steam or steam generation is an important utility for most of the pharma units in Sikkim. The steam is generated in a fuel-fired boiler and is further distributed into process through steam distribution systems. The energy efficiency in steam generation and steam distribution is an important area as it accounts for approximately 25-30% of the energy cost. Following are some of the key energy conservation measures in steam generation and steam distribution systems:

Table 5: Energy Efficiency Measures in Steam Generation and Distribution Systems

Energy Efficiency in Steam Generation and Distribution Systems	
Steam Generation – Boilers	
Use of Energy Efficient Boilers	Fuel Switch (HSD to Briquette)
Excess Air Control	Boiler Process Automation, Control & Monitoring
Improved Insulation	VFD for ID Fan
Proper Boiler Maintenance	Automatic Blowdown
Economizer and Air Preheaters	Condensate Recovery
Steam Distribution	
Appropriate Selection of Steam Trap	Improved Insulation
Reduced Pressure drop in pipelines	Steam Trap monitoring and maintenance
Recovery of Condensate	Flash Steam Recovery
Steam Monitoring and addressing steam leaks	Proper Design of Distribution Systems
Management Systems	
Effective monitoring of Key Parameters	Root Cause Analysis

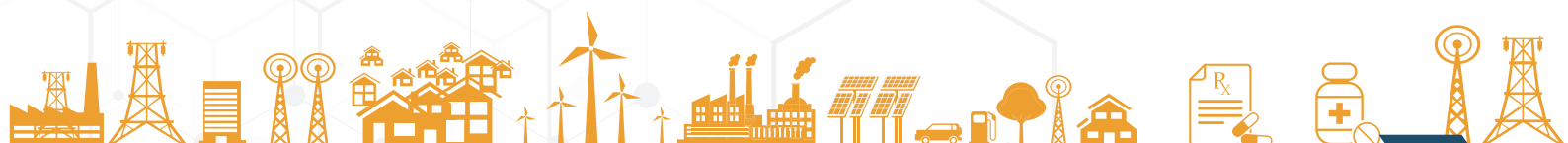

3.2.2 Energy Efficiency in Refrigeration Systems

Refrigeration system is the heart of any pharma unit. For a typical unit, the refrigeration load can be in the range of 30-40% of the overall electrical load and is hence a significant contributor to overall energy expenses. Thus, energy efficiency at refrigeration can significantly impact the energy consumption and energy cost for the unit. Over the years, there have been many technology developments in the refrigeration systems in compressors, condensers, pump sets, controls, etc. Some of the energy efficiency measures in the refrigeration system are as follows:

Table 6: Energy Efficiency in Refrigeration Systems

Energy Efficiency in Refrigeration Systems	
Compressors	
Use of Screw Compressors	Installation of Variable Frequency Drive (VFD)
Appropriate Refrigeration Charge	Compressor Control and Scheduling
Optimum Suction Pressure	Preventive maintenance
Two-Stage Compression	Process Automation & Control
Condensers and Evaporators	
Use of Evaporative Condensers	Preventive maintenance of Condensers
Automatic Tube Cleaning Systems	VFD for Fans
Reducing condensing pressure	Auto Controls
Cycling of evaporators fans	EC Fans for AHU
Cooling Load Management	
Piping Insulation	Doors/Curtains for Cold Rooms
Minimizing Heat Infiltration	Separation of Cold/Hot Areas
Insulation Paint	Maintenance of Heat Exchangers
Others	
Use of Energy Efficient Motors	Waste Heat Recovery from Compressors
Dedicated compressor for Packing Room Cooling	Chilling Centre Monitoring Systems
Use of Vapour Absorption Systems	

3.2.3 Energy Efficiency in Utilities

The utilities such as compressed air, electrical distribution systems, waste water treatment, lighting and other areas are also energy consuming sections in a plant, and here also many energy efficiency improvement opportunities are available for units. The following table provides an overview of possible energy efficiency opportunities in utilities:

Table 7: Energy Efficiency in Utilities

Energy Efficiency in Utilities	
Compressed Air Systems	
Use of Screw Compressors	Use of Demand Side Controller
Energy Efficient Air Dryers	Auto Drain Valves
Use of VFD	Appropriate Ventilation in Compressor Room
Optimum Generation Pressure	Compressor Leakage (less than 5%)
Pneumatic Equipment to Electric Equipment	Proper distribution systems
Electrical Distribution Systems	
Automatic Power Factor Controller (pf. 1)	Harmonic Filters
Energy Efficient Transformers	Optimum Voltage and line balance
Optimum Loading of Transformers	Energy Monitoring Systems
Pumps	
Energy Efficient Pump Sets	Trimming of Impellers
Maintenance of Pump Sets	Coating for Casing
VFD for Pump Sets	Pumping System Layout
Motors	
Energy Efficient Motors	Star to Delta Conversion
kVAR Compensators	Preventive Maintenance
Optimum Loading	Belt Driven to Direct Coupled
Lighting & Fans	
Use of LED Lights	Use of Brushless Direct Current (BLDC) – Ceiling Fans
Occupancy Sensors	Use of Natural Light (Light Pipe)

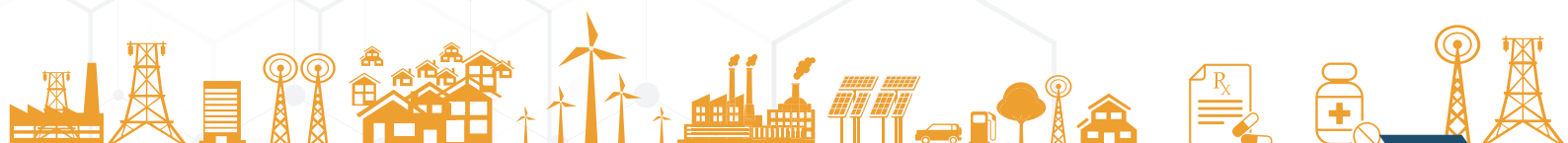

Energy Efficiency in Utilities	
Heating Ventilation and Air Conditioning (HVAC)	
Use of Star Rated AC	Use of Energy Efficient Air Handling Unit (AHU)
Smart AC Controller	Variable Refrigerant Flow units
Energy Monitoring and Control	Optimum Cooling at 24°C
Renewable Energy	
Solar PV Installation	Solar Thermal (Evacuated Tube)
Biogas Utilization	Briquette-fired boilers
Waste Water Treatment	
Use of Membrane Bio-Reactor (MBR) System	Bio-Gas Utilization (Piped Natural Gas)
Energy Efficient Pump Sets	Energy Efficient Blowers
Automation and Control	
Other measures	
Pinch Analysis	Cogeneration
Trigeneration	Application of Internet of Things (IOT)
Water Conservation Measures	
Rainwater Harvesting	Water Efficient fixtures
Reuse of water in gardening	Application of IOT
Energy Management Systems	
Implementation of ISO 50001:2018 – Energy Management Systems	Energy Efficiency Targets and Improvements (Roadmaps)

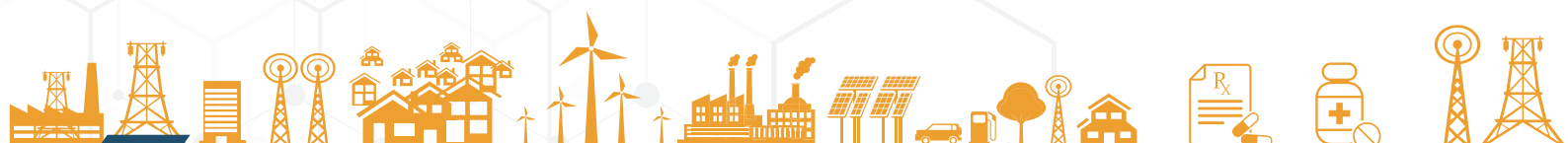

3.2.4 Best Practices and Key Indicators for Energy Efficiency

In addition to the above measures, the pharma units can also follow industry best practices, and monitor key performance indicators for ensuring energy efficient operations and processes.

Table 8: Best Practices for Energy Efficient Operations

Sr. No.	Measures	Productivity Impact	Estimated Savings
Steam Generation and Distribution			
1	Generate and transfer steam closer to rated boiler pressure	More output when compared with low pressure steam generation.	3% - 4% fuel savings
2	Utilize steam at lowest pressure in case of indirect heating	Better heat transfer, less cycle/ heating time, fuel saving and productivity.	For an indirect process requirement with temperature of 80°C, if steam at 3.5 kg/cm ² g is used instead of 2 kg/cm ² g, the heat loss is in the range of 2% - 3%.
3	Maintain high boiler feed water temperature	Increased boiler efficiency	Increasing feed water temperature by 1 °C results in 1% fuel savings.
4	Maintain Flue Gas Stack exit temperature between as low as possible depending on fuel	Increased life of components in flue gas circuit like duct, fan, and stack. Reduction in downtime and maintenance cost.	Every 22 °C reduction in flue gas exit temperature results in 1% fuel savings.
5	Install Auto Blow Down System	Lower fuel cost due to reduction in makeup water and better boiler efficiency.	Annual savings of 18 Tons of briquette for a 2 TPH boiler operating with continuous manual blowdown.
6	Condensate Recovery from Process	Improves boiler efficiency	10% - 15% fuel savings with 90% condensate recovery.
Refrigeration Systems			
7	Raise the chilled water temperature and reduce condenser water temperature to max possible extent	Optimum cycle time and energy consumption	Raising of chilled water temperature by 0.5°C to 1°C results in 2% - 3% power saving, and if the condenser water temperature is decreased by 2°C to 3°C, the system efficiency can increase by as much as 2% - 3%.
8	Avoid scale formation and fouling in heat exchangers	Optimum cycle time and energy consumption	2% - 3% savings in compressor power
9	Install Variable Frequency Drives (VFDs) for evaporator fans.	None	10% - 15% savings in evaporator fan power consumption
10	Waste Heat Recovery from chiller compressor	None	7% - 8% fuel savings
11	Replacing shell and tube condenser with evaporative condenser	Water savings	50% savings in condenser auxiliary power and 8% - 10% savings in compressor power.
12	Installation of VFD for chiller compressor	None	8% - 10% power savings

Sr. No.	Measures	Productivity Impact	Estimated Savings
Compressed Air			
13	Arrest air leakages in the compressed air system	Zero down time due to instrumentation fault / low compressed air pressure fault. Target less than 5%.	Every 10% reduction in air leakage reduces the electrical energy consumption by 10%.
14	Generate compressed air at the optimum pressure	None	A reduction in the delivery pressure by 1 bar in a compressor would reduce the power consumption by 8%.
15	Replacement of old inefficient compressor with screw compressor	Zero down time due to less maintenance	10% - 15% compressor power savings
16	Installation of VFD in air compressor to avoid unloading	None	15% compressor power savings
Others			
17	Replace low efficiency pumps with energy efficient pumps	Reducing the cycle time for process applications	15% - 25% savings in power
18	Use of VFDs for controlling the pump speed as per process requirement	None	20% - 30% savings in power
19	Improvement of overall power factor of the plant	None	10% - 20% cost savings
20	Installation of light pipe to avoid artificial lights during day time	None	100% savings in power
21	Replacement of Ceiling Fans with Energy Efficient BLDC fans	None	50% power savings
22	Replacing old rewind motors with energy efficient motors	None	20% - 30% savings in power
23	Energy savers for split ACs	None	20% - 30% savings in power
24	Biogas Generation from ETP	None	2% - 3% energy reduction
25	Solar Thermal System	None	5 kl Solar thermal can result in INR 2.5 Lakh saving

Monitoring of critical parameters of facilities and equipment is essential for ensuring optimal performance of key energy consumers in the pharma sector. Some of the useful energy indicators which plants can utilize for monitoring their performance are given below:

Table 9: Energy – Key Performance Indicators

Sr. No.	Parameter	Measurement Unit	Indicator
1	Boiler Steam Pressure	kg/cm ²	Nearer to boiler rated pressure
2	Boiler Steam Temperature	°C	Nearer to boiler rated temperature
3	Boiler Water TDS	ppm	3,200 – 3,500 ppm
4	Oxygen in Boiler Flue Gas	%	FO/NG fired – 2.5% – 3% Briquette/Wood fired – 4%
5	Boiler Flue gas temperature	°C	120 - 180 °C for package boilers
6	Steam to Fuel Ratio / Evaporation Ratio		2 - 3.5 for biomass fired boilers 4 - 7 for coal fired boilers 11 - 14 for oil /gas fired boilers
7	Feed Water temperature	°C	Above 85 °C
8	Range of Cooling Tower	°C	9 - 12 °C
9	Approach of Cooling Tower	°C	3 - 4 °C
10	Refrigeration Compressor Specific Energy Consumption	kW/TR	0.8 - 0.9 kW/TR for Screw Compressors 1.1 - 1.3 kW/TR for Reciprocating Compressors
11	Compressed air Generation Pressure	kg/cm ²	Closer to user requirement
12	Compressed air Loading %	%	80 - 90%
13	Compressed air Unloading %	%	10 - 20 %
14	Compressed air SEC	kW/cfm	0.18 kW/cfm for Screw Compressors 0.14 kW/cfm for Reciprocating Compressors
15	Electrical Parameters for Motors	kW, V, I, A, PF	Voltage +/-5% of rated voltage Within +/-5% of rated current Motor Loading > 80% for better efficiency range
16	Electrical Parameters	kW, V, I, A, PF, Harmonics	Plant LT voltage should be 410 -415V PF closer to unity Transformer loading - 50% -60% VTHD < 8% at 415 V side ITHD < 15% at 415 V side



4. Energy Efficient Technologies – Case Studies

4. Energy Efficient Technologies – Case Studies

The energy efficiency measures mentioned in previous chapters are some of the measures implemented in the pharma units. The following chapter focuses on some of the above-mentioned technologies which are promising and have been implemented in a few units and have great potential for implementation (Case Study). These technologies are described in more detail, and wherever possible, a case reference from a unit that has implemented the technology has been included. In most of the examples, typical energy saving data, Greenhouse Gas (GHG) emission reduction, investments, payback period, etc., have been highlighted. As these case studies are included to provide confidence to units to implement the technologies, the applicability of these measures may vary from unit to unit, and further technical and financial analysis would be required for individual units. Following case studies are mentioned in detail in the subsequent section:

Table 10: Case Studies for Pharma Sector

Sr. No.	Technologies
Steam Generation and Distribution	
1	Conversion of HSD-fired Boiler to Biomass-fired Boiler
2	Condensate Recovery System
3	Steam Operated Pumping Traps
4	Heat pump for process/boiler feed water heating
Refrigeration Systems	
5	VFD in Reciprocating Chiller Compressor
6	Waste Heat Recovery from Chiller Compressor
7	kVAr Energy Compensator for Chiller Compressor
8	VFD for chilled water pumps
9	Evaporative Condenser
10	Electronically Commutated motors for AHUs
11	Online Condenser Cleaning System
12	Install three port valves with two-port valves for AHUs and install VFD for chilled water pump
13	Active refrigerant agent addition in lube oil for chillers

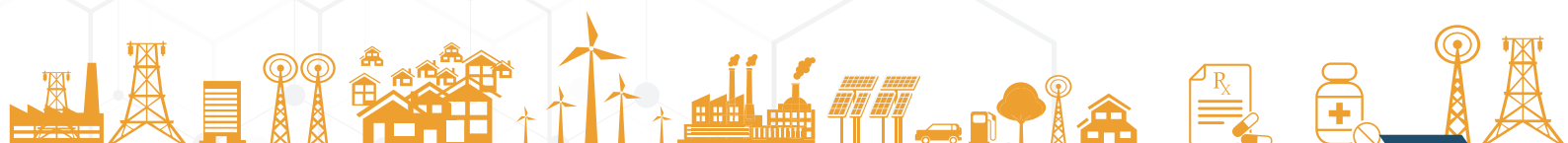

Sr. No.	Technologies
Utility	
14	VFD for Air Compressor
15	Energy Efficient Pumps
16	Package Type Biogas Reactor
17	IoT based Water Management System
Renewable Energy	
18	Solar Rooftop system
19	Solar Thermal System
20	Solar-Wind Hybrid system

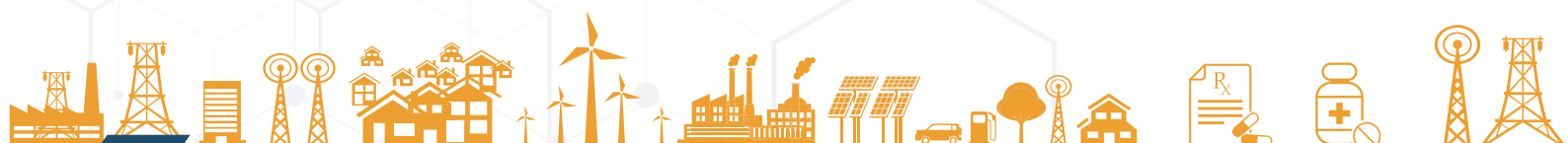

4.1 Case Studies in Steam Generation and Distribution

4.1.1 Conversion of HSD-fired Boiler to Biomass-fired Boiler

Baseline Scenario

The unit has installed two numbers of 2-TPH HSD-fired three-pass boilers for steam generation, which are used for process applications. The HSD consumption of one boiler was identified to be at 36 litres/hr. The average steam demand is 450 - 600 kg/hr at 7.5 - 10 kg/cm² g. Normally, temperature levels of process steam of the plant are below 130°C.

The average steam generation per day is 0.7 tons with an average consumption of 420 to 600 kg/hr. The peak steam requirement in plant is 1,200 kg/hr, when all processes are in operation. The boiler and fuel parameters are shown below:

Table 11: Boiler and Fuel Parameters

Parameter		
Boiler Type	Fire Tube, HSD Fired, Shell Type	Fire Tube, HSD Fired, Shell Type
Boiler Capacity	2 TPH	2 TPH
Boiler Design Pressure	10.5 kg/cm ² g	10.5 kg/cm ² g
Boiler Operating Pressure	7.5 – 9.5 kg/cm ² g	
Average Operating Hours	15 hours per day (2 shifts/ day)	
Fuel		
Fuel Type	HSD	
Fuel GCV	45,187 kJ/kg	
Fuel Firing Process	Auto	
Cost of Fuel	INR 67/- per litre	
Average Fuel Consumption	36 litres per hour	
Number of working days	365 days per year	

Proposed System

An efficient replacement for the current HSD-fired boiler will assist in cutting down the increasing production cost. As far as the plant is concerned, their objective is to go towards greener production and with minimal production cost. A sustainable fuel to generate heat for the process should be seen as a sustainable development opportunity. It is therefore highly recommended to install a new boiler in the plant with an alternative sustainable fuel-like wood or briquette.

HSD used in Boiler can be totally substituted by Wood or Briquette with an equivalent ratio of 2.7:1 kg/litre on the basis of calorific value. This usually results in saving of more than 60% in operating cost, and will have attractive payback period.

Pre-requisite of the boiler substitution:

Availability of good quality new fuel (wood / briquette)

The availability of good quality and continuous supply of fuel is very important. To be feasible for this project, it is suggested that the boundary of the fuel supply distance should have less than a 30 km radius circle. In case of sudden unavailability of fuel, there should be another fuel option.

Availability of sufficient space for new boiler installation

Another factor is the availability of sufficient area. The required space for the boiler and the fuel storage has to be checked with the supplier, and the plant has to make necessary arrangement for the same. It is highly recommended to install new generation biomass-fired boiler with automation which works on the principle of continuous monitoring and controlling.

Merits

- ❖ Automation results in feeding optimum amount of fuel to boiler, and thus reduces unburnt loses.
- ❖ Ensures max possible feed water inlet temperature, so that the generation will be maximum possible.
- ❖ Better water quality.
- ❖ Ensures periodic maintenance of boiler tubes, hence reduction in radiation loss.
- ❖ Zero emissions.

Limitations

- ❖ It is suggested that the boundary of the fuel supply distance should be less than a 30 km radius circle.
- ❖ Estimation of proper back pressure.
- ❖ Availability of sufficient space for new boiler installation.
- ❖ Storage area for fuel to keep it dry and away from moisture attack.

Cost Benefit Analysis

The expected fuel savings to be achieved by installation of fully automated biomass-fired boiler is 1,89,258 litres of HSD annually. The annual monetary saving for this project is **INR 84.20 lakh, with an investment of INR 60 lakh, and a payback period of 9 months.**

Table 12: Cost Benefit Analysis – Energy Efficient Boiler

Sr. No.	Description	Unit	HSD	Briquette
	Average steam consumption	kg/hr	433	433
	Steam Enthalpy at 10 Kg/cm ² g pressure	kJ/kg	2,794	2,794
	Boiler Efficiency	%	75	75
	Fuel Calorific Value	kJ/kg	45,187	18,828
	Fuel Consumption	kg/hr	36	86
	Fuel Cost	INR/kg	67	6.6
A	Cost of fuel per hour	INR/hr	2,393	566
	Ash generated (Total)	kg	0	8
	Rate of Ash Disposal	INR/kg	0.2	0.2
B	Cost of Ash Disposal per hour	INR/hr	0	1.60
	Power Consumption for Utilities	kW	14	19
	Rate of Power	INR/kWh	6	6
C	Cost of Power Consumption per hour	INR/hr	84	114
	Labour for fuel feed per hour	Nos	0	2
	Manual-hour rate of labour	INR/hr	75	75
D	Cost of Labour per hour	INR/hr	0	150
E	Total Running Cost per hour (A+B+C+D)	INR/hr	2,477	831
	Annual hours of operation	hrs	5,300	5,300
F	Total Running Cost per annum	INR lakh	131.30	44.1-
	Average Annual Maintenance Cost	INR lakh	2	5
G	Total Operational Cost per annum	INR lakh	133.30	49.10
H	Total Saving per annum with Solid fuel	INR lakh	84.20	
I	IRR	%	169.21	
J	Net Present Value (NPV) at 70 % Debt (12% rate)	INR Lakh	399.17	

Energy & GHG Savings



Vendor details

Table 13: Vendor details – Energy Efficient Boiler

Equipment Detail	Energy Efficient Boiler
Supplier 1	
Supplier Name	Forbes Marshall
Address	Forbes Marshall, Kolkata
Contact Person	Mr. Rahul
Mail Id	rchakraborty@forbesmarshall.com
Phone No	9995752525 / 9744133211
Supplier 2	
Supplier Name	Thermax Pvt Ltd
Address	Greenergy Solution Pvt Ltd (Local Dealer) Block 'C', 1st Floor PCM Bus Terminus & Commercial Complex 2nd Mile, Sevoke Road, Siliguri
Contact Person	Mr. SabyaSachi Banerjee
Mail Id	sabyasachi@greenergy.net.in
Phone No	+91 094340-76408

4.1.2 Condensate Recovery System

Baseline Scenario

The unit has installed one 2-TPH HSD-fired boiler for the process applications. There are three blocks, namely, I, II, and III, and MEE plant where steam requirement have been met by 2-TPH boiler of 7 kg/cm², 150°C. The steam is used in the following processes/sections:

- ❖ Reactors
- ❖ MEE plant
- ❖ Hot water generator of ANFD
- ❖ Steam ejectors and other users.

At present, the condensate recovery is low (around 15 - 20%), and there is a good potential to recover the condensate which will give appreciable savings in fuel apart from the savings in water. Condensate can be recovered from:

- ❖ Reactors heating
- ❖ Tray Driers

Proposed System

Condensate recovery is a process to reuse the water and sensible heat contained in the discharged condensate. Recovering condensate instead of draining it can lead to significant savings of energy, chemical treatment and make-up water. Install a flash vessel and condensate transfer/ pumping unit to recover all the condensate from various processes. Condensate pumping/ transfer system can pump a huge quantity of condensate, effectively utilizing steam, known as motive steam. Condensate is one of the purest forms of water having low electrical conductivity of only 5 µS/cm, or TDS value of 3.5 ppm.

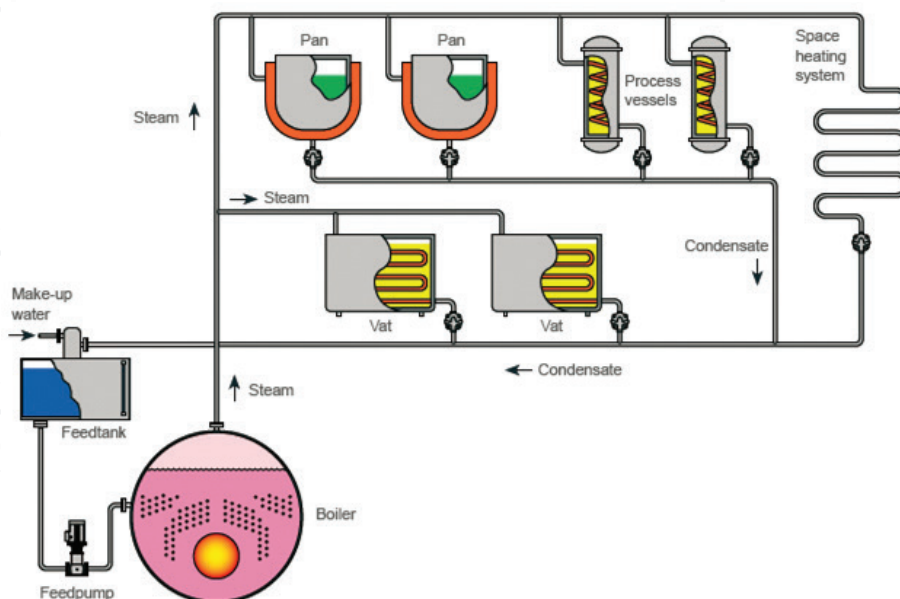

Figure 9: Typical condensate recovery system

Condensate flows from receiver of the pump to the pump body, and the level of water starts increasing and reaches the high level. This is sensed by the conductivity-based level sensor, which activates the motive steam inlet valve. Steam enters the pump at high pressure and the pressure in the pump body keeps on building till it overcomes the back pressure of the delivery side. Now, the outlet check valve opens, and the condensate starts flowing out of the pump body, using high pressure of the steam. As soon as the level in the pump reaches the low-level position, the inlet valve for the motive steam is de-activated, and the pump is depressurized. The pump again starts filling and the cycle repeats.

The system requires no electric motor for operation. As the quantity of condensate discharged at each stroke is known, the total volume passed during a given period can be calculated by counting the number of strokes during the period. Such a counter is provided, enabling display of the total condensate pumped. The totalized volume of condensate pumped is displayed on an electronic unit.

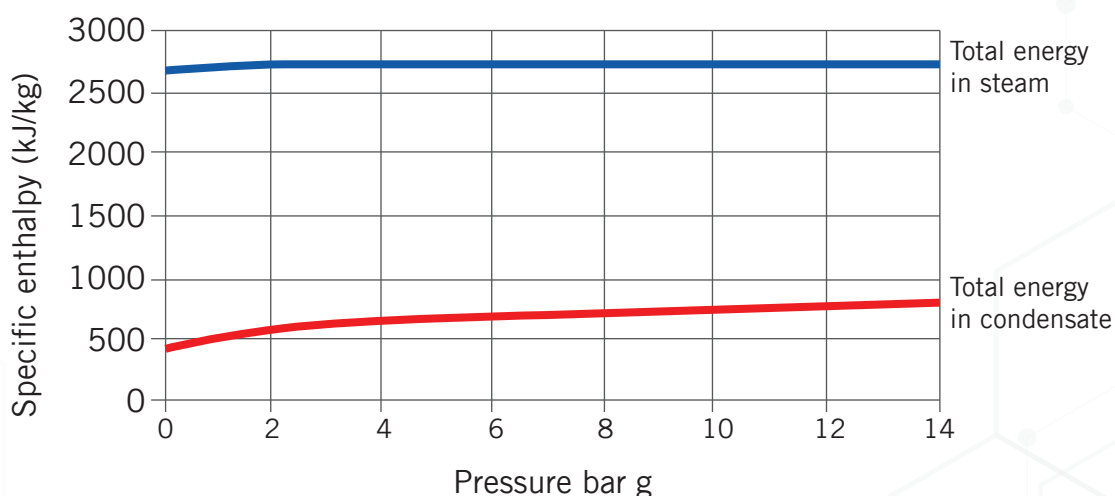

Figure 10: Heat content in condensate

A flash steam generator can be installed for recovery of flash steam just before the condensate recovery system. When high pressure condensate is discharged from steam traps to low pressure condensate return lines, excess energy is released in the form of flash steam. This flash steam can be used to heat boiler feed water or for low pressure steam application.

Merits

- ❖ High availability due to zero moving parts.
 - ❖ High reliability and equipment availability.
 - ❖ Low wear & tear.
 - ❖ Low maintenance.
 - ❖ Low downtime.
- ❖ High motive inlet pressure; no need of pressure reducing valve/ station till 10 kg/cm², where low pressure steam is not available, hence saving on installation cost.
- ❖ High discharge of condensate: 50 litres per stroke.

- ❖ High condensate temperature return: No cavitation issues over electrical pumps.
- ❖ Conductivity-based level controller (a stringent quality & design process followed in European market, to ensure safe operation).
- ❖ A large LED display with flow totalizer to display the total volume displaced.
- ❖ Suitable for outdoor installations.
- ❖ Energy efficient pump; steam trap drains and pump vent taken back to the receiver tank to minimize vent losses.
- ❖ Electrical motor required.

Limitations

- ❖ Requires regular maintenance.
- ❖ Estimation of proper back pressure.
- ❖ Inventory of electronic spare parts to be maintained.

Cost Benefit Analysis

The expected fuel savings to be achieved by installation of condensate recovery system is 30,000 litres of HSD annually. The annual monetary saving for this project is INR 20.10 lakh, with an investment of INR 7.00 lakh, and a payback period of 04 months.

Table 14: Cost Benefit Analysis – Condensate Recovery Systems

Parameters	UOM	
Boiler Capacity	TPH	2
Operating Pressure	kg/cm ²	9
GCV	kJ/kg	45,187
Fuel Cost	INR/litre	67
Fuel Consumption	litre/hr	52
Boiler Efficiency	%	75
Enthalpy of steam at 9 Bar	kJ/kg	2,773
Steam Flow	kg/hr	1,200
Condensate Available considering losses	kg/hr	900
Condensate Working Pressure	kg/cm ²	1.5
Flash Steam	%	5.19
Mass of Flash Steam	kg/hr	46
Mass of Condensate Available	kg/hr	853.33

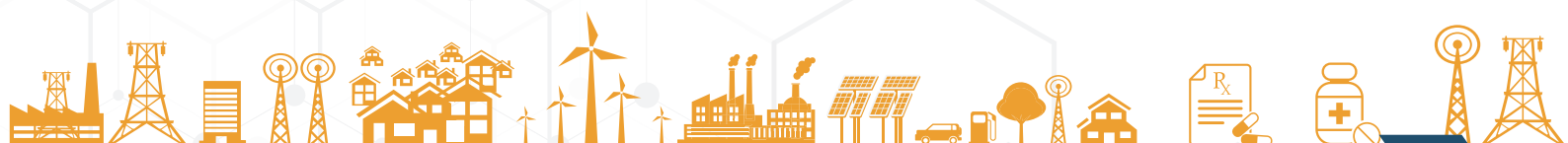

Parameters	UOM	
Latent Heat of flash steam	kJ/kg	2,107.5
Fuel saved from condensate recovery	kg/hr	4
Fuel saved from flash steam recovery	kg/hr	3
Total Fuel Saved	kg/hr	7
Total Fuel Saved	litre/hr	8.33
Operating Hours	hours	10
Operating Days	days/year	360.00
Annual Fuel Savings	litres	30,000
Monetary Savings	INR lakh	20.10
Investment	INR lakh	7.00
Payback period	months	04
IRR	%	319.49
NPV at 70% debt (12% rate)	INR lakh	98.64

Energy & GHG Savings



Implementation Details

Table 15: Implementation Details - Condensate Recovery System

Project Name	Condensate Recovery System
Objective	Installation of condensate recovery system.
Unit profile	Mylan laboratories Unit 8 is located at Vizianagaram and it produces Active Pharmaceutical Ingredients with a plant capacity of 1,198 kl

Project Name	Condensate Recovery System
Installation Photo	
Assumptions	<ul style="list-style-type: none"> ❖ Fuel used – Coal ❖ GCV – 20,920 kJ/kg ❖ Annual operating hrs – 6,000
Savings (INR lakh)	₹ 10.00
Investment (INR lakh)	₹ 8.00
Simple Payback Period	10 months
Replication potential	In all the pharma units
Outcomes	<ul style="list-style-type: none"> ❖ Condensate recovery factor increased to 39% ❖ Increase in feed water temperature
Unit contact details	Mr. G L Srinivas Mylan Laboratories Limited – Unit 8 G. Chodavaram Village, Pusapatirega Mandal, Vizianagaram Dist, A.P. Email: srinivas.ghattamaneni@mylan.in
Cluster Reference	Andhra Pradesh

Vendor details

Table 16: Vendor Details – Condensate Recovery Systems

Equipment Detail	Condensate Recovery
Supplier 1	
Supplier Name	Forbes Marshall
Address	Forbes Marshall, Kolkata
Contact Person	Mr. Rahul
Mail Id	rchakraborty@forbesmarshall.com
Phone No	9995752525 / 9744133211
Supplier 2	
Supplier Name	Thermax Pvt Ltd
Address	Greenery Solution Pvt Ltd (Local Dealer), Block 'C', 1st Floor, PCM Bus Terminus & Commercial Complex, 2nd Mile, Sevoke Road, Siliguri
Contact Person	Mr. SabyaSachi Banerjee
Mail Id	sabyasachi@greenery.net.in
Phone No	+91 094340-76408

4.1.3 Steam Operated Pumping Traps

Baseline Scenario

The unit has installed a 2-TPH and a 1-TPH HSD-fired boiler in the plant. Both boilers are at the same boiler house, and at any given time, only one boiler is working. For most of the time, 2-TPH boiler is running to cater to the steam demand. The other boiler runs when the 2-TPH boiler is under maintenance.

Steam traps are used to separate the condensate from the steam as soon as it is formed and hence the rate of formation of further condensate will be reduced. At the same time, steam traps prevent the leakage of steam to the atmosphere and hence steam loss will be eliminated. It is observed that some steam traps off reactors have been bypassed due to the failure. In Block 1, steam traps have not been installed for many reactors and steam traps failure and unavailability leads to passage of steam into the atmosphere.

The steam traps of reactors are installed with 25 NB Ball Float Steam Trap. The temperature control valve is also installed, and the PID is enabled. The bypass is open for all the equipment at times. We could see the steam coming out through the bypass. The ghee kettle is installed with Inverted Bucket traps. No automatic air vents are provided. Since the PID temperature control valves are installed, and the temperature requirement is at 90 - 110°C, there are chances of stalling of condensate and because of that, while operating, the bypass of the trap is open at times. This results in loss of steam through the bypass. Also, the steam pressure is given at 3.5 kg/cm² which can be even reduced to less than 2 kg/cm².

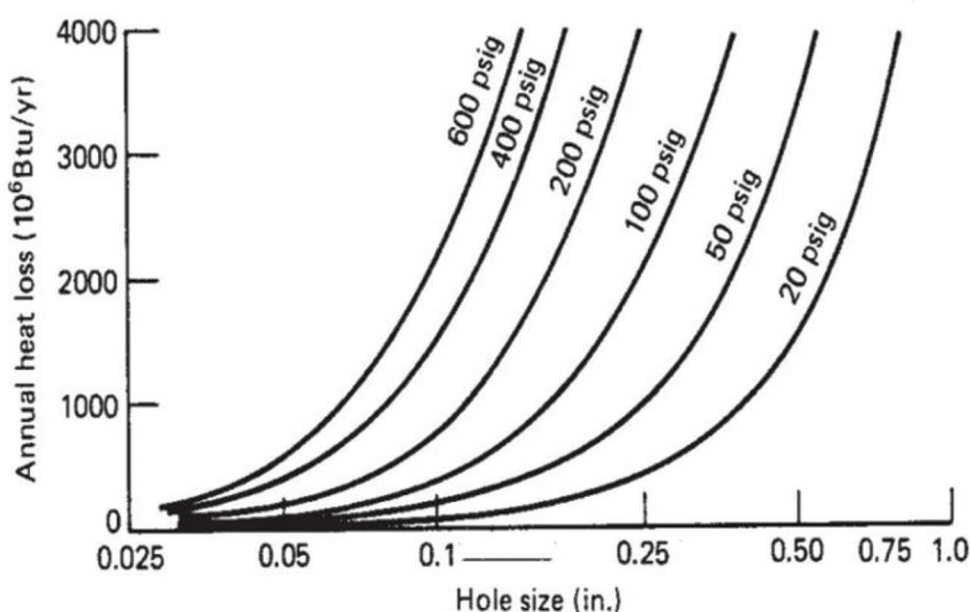

Figure 11: Steam Loss Chart

A steam trap will be operational only above the rated minimum differential pressure. Normally, operation of a steam trap requires a minimum differential pressure of 0.1 kg/cm², however, this may vary with manufacturers. If the condensate flow pressure is lesser than the minimum required differential pressure, water logging happens, which is also called stalling. This leads

to problems of hammering, reduction of thermal performance of heat exchanger, corrosion of heating surfaces, inevitably reducing the service life of the exchanger.

Now, to avoid this stall condition of steam traps, equipment operator normally operates the by-pass valve, either keeping bypass line partially open full-time or intermittently opening and closing it. In both the cases, live steam loss occurs, thereby increasing the energy consumption. The orifice size of 15 NB bypass valve open is 5 mm at 3.5 kg/cm² operating pressure. Through this orifice size, steam loss is 30 kg/hr from the steam loss chart.

Proposed System

It is recommended to replace the ball float steam trap with Steam Operated Pumping Trap (SOPT). With this system in place, whenever the condensate pressure is low, motive steam/ air shall provide the additional thrust to make the condensate flow and avoid any stalling.

Merits

- ❖ Improved condensate recovery.
- ❖ Reduced steam leakages through the system.

Limitations

- ❖ Proper maintenance is required.

Cost Benefit Analysis

The expected fuel savings by installation of SOPT is 19,302 litres of HSD annually. The annual monetary saving for this project is **INR 12.93 lakh, with an investment of INR 5.11 lakh, and the Payback period for the project is 05 months.**

Table 17: Cost Benefit Analysis – Installation Steam Operated Pumping Traps

Parameters	UOM	
Orifice Size	mm	5
Operating Pressure	bar	3
Steam loss through orifice	kg/hr	30
Considering 50% live steam leakage	kg/hr	15
Hence steam leakage/day from single bypassed trap (Considering average running 5 hrs/day)	kg/day	75
Total No. of by passed traps	Nos.	4
Total steam leakage	kg/day	300
Steam Cost	INR/kg	2
Operating days		360.00

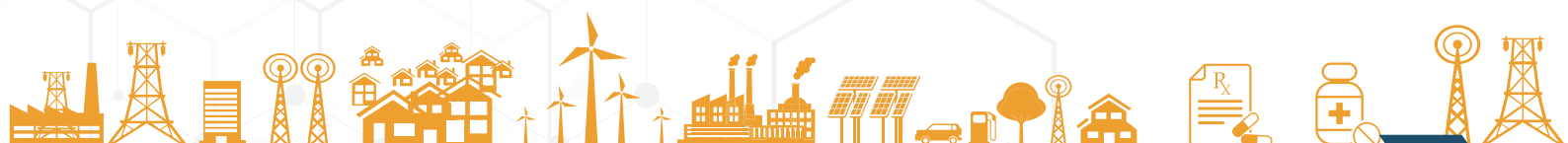

Parameters	UOM	
Fuel Loss	kg/day	63.83
Fuel Cost	INR/litre	67
Annual Fuel Savings	litres	19,302
Monetary Savings	INR lakh	12.93
Investment	INR lakh	5.11
Payback period	months	05
IRR	%	284.87
NPV at 70% debt (12% rate)	INR lakh	63.18

Energy & GHG Savings



Vendor Details

Table 18: Vendor Details – Steam Operated Pumping Traps

Equipment Detail	SOPT
Supplier 1	
Supplier Name	Forbes Marshall
Address	Forbes Marshall, Kolkata
Contact Person	Mr. Rahul
Mail Id	rchakraborty@forbesmarshall.com
Phone No	9995752525 / 9744133211

4.1.4 Steam Driven Heat Pump

Baseline Scenario

The unit has installed two HSD-fired boilers for the process application. One 1.0-TPH HSD-fired boiler operating at 9 kg/cm² is running and the other is on standby. The heating process is done by indirect heating. Other than the process applications, the unit has installed two hot water generators of 191 kW heating load to generate hot water at 55°C for supplying it to the AHUs to maintain proper room conditions along with humidity control. The current steam consumption for this application is 280 kg/hr and return water from AHUs is coming at 45°C.

Proposed System

It is recommended to install a 191 kW steam driven heat pump for generating hot water at 55°C for the AHUs. Heat naturally flows from a higher temperature to lower temperature. Heat pump is an equipment which is able to force the heat flow in the other direction. Heat pumps drive heat from a lower temperature to medium temperature, using high grade energy. Absorption heat pumps are thermally driven, which means that heat rather than mechanical energy is supplied to drive the cycle. The steam required for running the VAM is 115 kg/hr compared to 286 kg/hr which is required for hot water generator.

Thermax Absorption heat pumps either utilise steam, hot water, exhaust, fuel, geothermal energy or any combination of these heat sources, to pump low grade heat. Heat is extracted from the heat source in the evaporator. Useful heat is given off at medium temperature through absorber and condenser. In the generator high temperature heat is supplied to run the process.

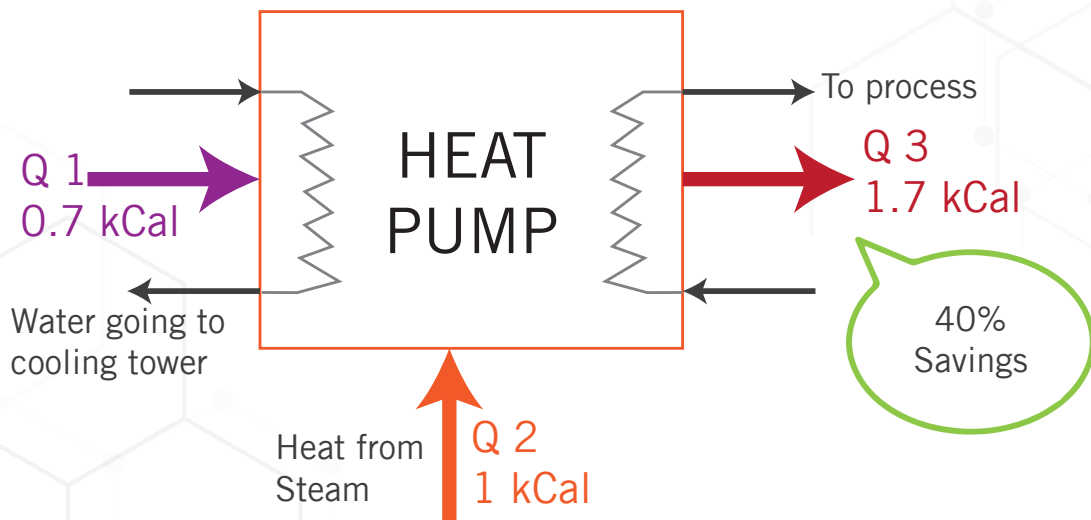
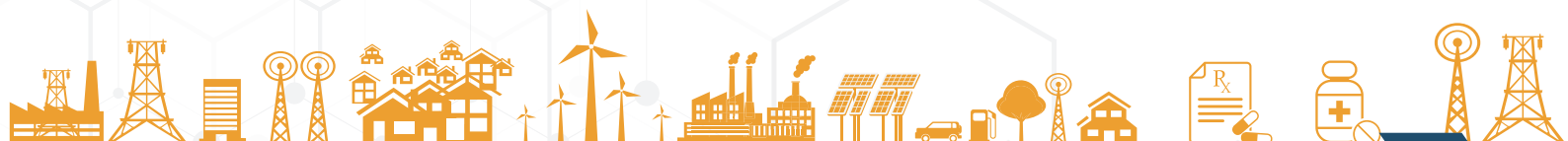

Figure 12: Schematic of Heat pump

Basic principle of operation

Vapour Absorption Machine uses water as the refrigerant and LiBr solution as the absorbent. The process of cooling goes through stages such as evaporation of refrigerant in evaporator, absorption of refrigerant by concentrated LiBr solution in absorber, boiling of dilute LiBr solution to generate refrigerant vapour in generator and condensation of refrigerant vapour in



condenser. The boiling point of water is directly proportional to pressure. At 6mmHg absolute pressure the boiling point of water is 3.7°C. To change water from liquid to vapour it must be heated. The heat, required to change the phase of a liquid to vapour, is called the Latent heat of evaporation.

Lithium Bromide (LiBr) is a chemical like common salt (NaCl). LiBr is soluble in water. The LiBr water solution has a property to absorb water due to its chemical affinity. As the concentration of LiBr solution increases, its affinity towards water vapour increases. Also as the temperature of LiBr solution decreases, its affinity to water vapour increases. Further, there is a large difference between vapour pressure of LiBr and water. This means that if we heat the LiBr water solution, the water will vaporise but the LiBr will stay in the solution and become concentrated.

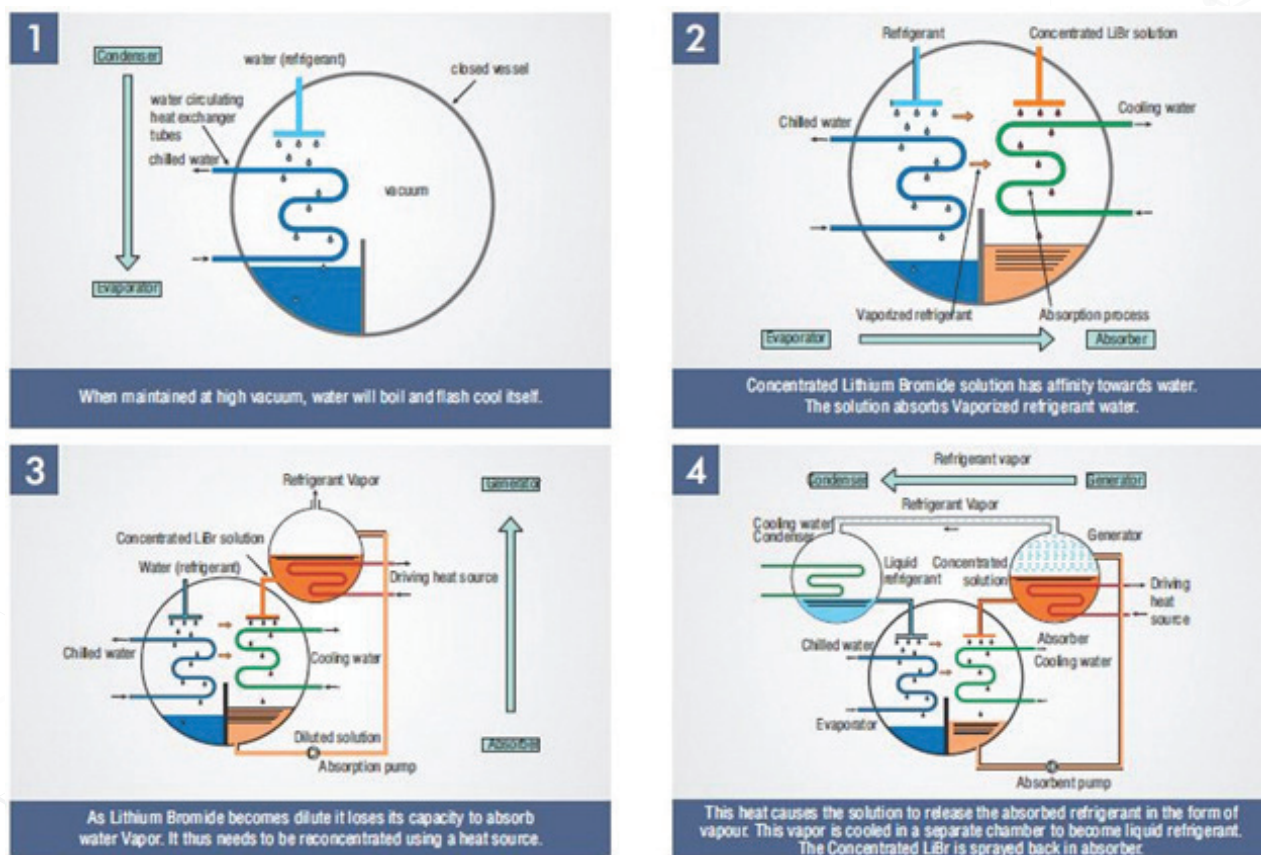

Figure 13: VAM working

Technical Specification

Table 19: Technical specification for VAM

	Units	Value
Heat Source Water Circuit		
Heat Source Water Flow Rate	m ³ /hr	25.1
Heat Source Water Temperature Inlet	°C	36.0
Heat Source Water Temperature Outlet	°C	32.0
Nozzle size	mm NB	80.0

	Units	Value
Maximum working pressure	kg/cm ² (g)	8.0
Hot Water Circuit (For AHU)		
Heat Rejected	kJ/hr	6,86,176
Hot Water Flow Rate	m ³ /hr	16.6
Hot Water Inlet Temperature	°C	45.0
Hot Water Outlet Temperature	°C	55.0
Nozzle size	mm NB	100.0
Maximum working pressure	kg/cm ² (g)	8.0
Driving Steam Circuit		
Heat Input	kW	75.0
Driving Steam Pressure (Dry saturated)	kg/cm ² (g)	8.0
Driving Steam Flow Rate (+/-5%)	kg/hr	115
Condensate Outlet Temperature	°C	80 to 100
Tube MOC		
Evaporator		Copper
Absorber		Copper
Condenser		Copper
Physical Data (+/- 10%)		
Length	m	2.8
Width	m	1.7
Height	m	2.3
Shipping Weight	Ton	3.4
Operating Weight	Ton	4.0
Electrical Rating		
Power Supply	V	415 (±10%)
	Hz	50 (±5%)
Absorbent Pump	kW (A)	1.1 (3.4)
Refrigerant Pump	kW (A)	0.1 (0.6)
Purge Pump	kW (A)	0.75 (1.8)
Total Power Consumption	kVA	5.20

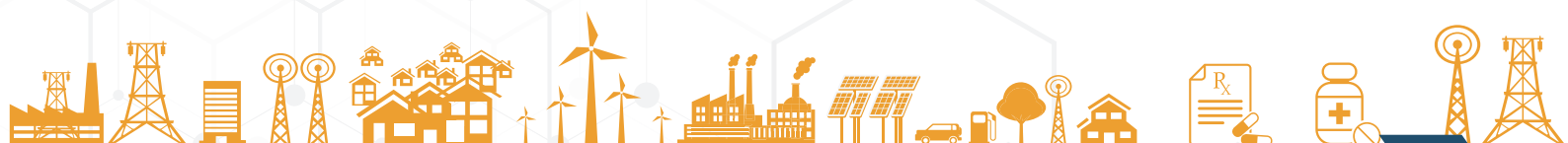

Merits

- ❖ Highly compatible.
- ❖ Improves the efficiency of boiler.
- ❖ Simultaneous delivery of heating and cooling.
- ❖ Easy installation and occupies less space near the utilization point.

Demerits

- ❖ High upfront cost.
- ❖ Requires system modification.

Cost Benefit Analysis

The expected fuel savings to be achieved by installation of heat pump is 1.07 lakh litres of HSD annually. The annual monetary saving for this project is **INR 71.81 lakh, with an investment of INR 30.00 lakh, and a payback period of 05 months.**

Table 20: Cost Benefit Analysis – Heat Pump

Description	Unit	VAM Heat Pump	Current PHE based system
Capacity	kW	191	191
Energy Source		STEAM	STEAM
Energy Consumption			
a) Steam Consumption	kg/hr	115.00	286.47
b) Power Consumption	kW	5.20	0.00
Total Power	kW	5.20	0.00
Energy Cost			
a) Steam Cost	INR/kg	5.50	5.50
b) Power Cost	INR/kWh	7.00	7.00
Hourly Energy Cost			
a) Steam Cost	INR/hr	632.50	1,575.59
b) Power Cost	INR/hr	36.40	0.00
Total Energy Cost	INR/hr	668.90	1,575.59
Fuel GCV (HSD)	kJ/kg	45,187	45,187
Savings per hour	INR/hr	906.69	
Annual Operating Hours	hrs.	7,920.00	7,920.00

Description	Unit	VAM Heat Pump	Current PHE based system
Annual Energy Cost	INR	52,97,688.00	1,24,78,706.42
Annual Savings	INR lakh		71.81
Investment	INR lakh		30.00
Payback period	months		5
IRR	%		270.97
NPV at 70% debt (@12% rate)	INR lakh		350.12

Energy & GHG Savings



Vendor Details

Table 21; Vendor Details – Steam Driven Heat Pump

Equipment Detail	Heat Pump
Supplier 1	
Supplier Name	Thermax Limited
Address	5th Floor, Gariahat Mall, 13, Jamir Lane, Kolkata
Contact Person	Zeeshan Ahmed
Mail Id	zeeshan.ahmed@thermaxglobal.com
Phone No	9804597674

4.2 Case Studies in Refrigeration Systems

4.2.1 VFD for Screw Chiller Compressor

Baseline Scenario

The unit has installed a 100 TR screw chiller for the chilled water requirement inside the plant. The performance of the chiller compressor is shown below:

Table 22: Operating Parameters of compressors

Parameters	UOM	
Evaporator Pressure	psi	32
Condenser Pressure	psi	135
Condenser leaving water temperature	°C	33.2
Condenser entering water temperature	°C	30.3
Evaporator leaving water temperature	°C	5
Evaporator entering water temperature	°C	8
Total Operating Power	kW	80.50
Operating TR	TR	88.20
SEC	kW/TR	0.90

Currently, the chiller compressor is running continuously at full load irrespective of the load variations in the plant.

Total compressor power for a system is a function of its suction pressure, discharge pressure, total system load, part load controls and unloading (specifically in the case of screw compressors which do not unload linearly). A lower refrigerant temperature results in lower suction pressure and increased compressor power requirements. A lower condensing pressure, which is a function of the condenser capacity and operations, results in a lower compressor discharge pressure and less compressor power.

Once the evaporator gets wet with the help of refrigerant and temperature is attained, if there is no speed control, the compressor will do the same work to attain lower refrigerant temperature, which results in lower suction pressure, thereby consuming same power as it is loaded. In such cases, VFD can reduce the power consumption with the help of speed control by proper feedback mechanism.

Proposed System

It is recommended to install VFD for one high speed compressor with suction pressure as the feedback. The VFD helps in smooth control of operation of the compressor and the high-speed compressor can take care of the load, when suction pressure of the low speed compressor exceeds the set value. At this time, the compressor with VFD can take care of the additional

demand due to increased suction.

Merits

- ❖ Better operating efficiencies.
- ❖ Reduced power consumption.
- ❖ Smooth control of compressor.
- ❖ VFD can act as a soft starter.

Limitations

- ❖ Speed reduction is possible up to only 25 Hz.

Cost Benefit Analysis

The expected electricity savings by installation of VFD for refrigeration compressor is 25,200 units annually. The annual monetary saving for this project is **INR 1.38 lakh, with an investment of INR 2.66 lakh, and Payback period for the project is 23 months.**

Table 23: Cost Benefit Analysis – VFD for Refrigeration Compressor

Parameters	UOM	
Total Compressor Power	kW	80.50
Refrigeration Load	TR	51.93
SEC	kW/TR	1.55
VFD Power Savings	%	10
Power Savings on one compressor	kW	4.2
Operating hours	hrs	6,000
Energy Savings	kWh	25,200
Cost Savings	INR lakh	1.38
Investment	INR lakh	2.66
Payback Period	months	23
IRR	%	73.04
NPV at 70 % Debt (12% rate)	INR lakh	5.78

Energy & GHG Savings



Vendor Details

Table 24: Vendor details – VFD for Refrigeration Compressor

Equipment Detail	VFD for chiller compressor
Supplier 1	
Supplier Name	Danfoss Industries Ltd
Address	703,7th Floor, Kaivanya Complex,Near Panchwati Cross Road Ambawadi, Ahmedabad
Contact Person	Mr. Srihari Vyas
Mail Id	Shrihari@danfoss.com
Phone No	9825024991

4.2.2 De-Superheater for Chiller Compressors

Baseline Scenario

The unit has installed two 50-TR capacity compressors for the chilling requirement in the plant. One compressor runs continuously, and second compressor runs based on load requirement. For the refrigeration purpose, vapour compression-based ammonia cycle is used. In a refrigeration cycle, when the compressor runs, the refrigerant starts flowing through the system.

The compressor continuously sucks low pressure, low temperature refrigerant vapours from the evaporator and pumps it to the condenser at a high pressure and temperature. While flowing through the condenser, the high temperature vapours release their heat to the atmosphere and condense to a high-pressure liquid state. After condenser, this high-pressure liquid enters the expansion valve where it is throttled to a low pressure.

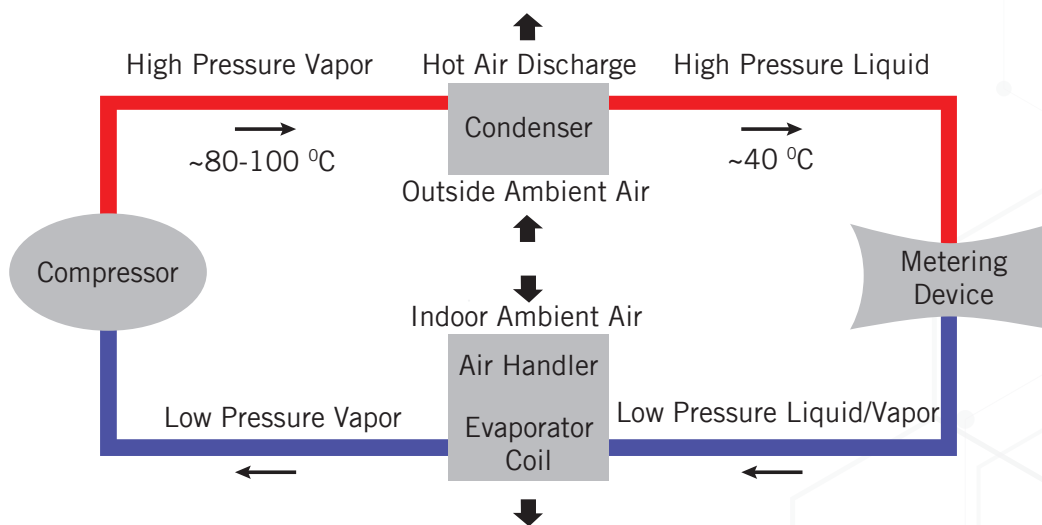

Figure 14: Vapour Compression Cycle

On throttling, the pressure and temperature of the refrigerant decrease, and when this low pressure, low temperature throttled liquid flows through the evaporator, it sucks heat and produces cooling. On absorbing heat in the evaporator, all the low-pressure liquid evaporates to low-pressure, low-temperature vapours, which are again sucked by the compressor. In this way, all these processes go on continuously and if the compressor runs, the system produces cooling around the evaporator.

Refrigeration plants with air-cooled and water-cooled condensers produce a lot of waste energy by dumping the condensation energy to the ambient air. By installing a de-superheater, a large proportion of this waste energy can be turned into hot water, which can be used for many applications such as:

- ❖ Boiler feedwater heating.
- ❖ Process heating
- ❖ Cleaning application

Proposed System

It is recommended to install de-super heater on discharge side of chiller compressors to recover the waste heat of ammonia gas. The temperature of NH_3 gas will be around 100°C , which can be cooled to 60°C , and the recovered heat can be used for heating water from ambient to 70°C . The design should ensure that adequate heat is recovered with the required temperature lift. Apart from the direct energy saving after getting hot water, the heat load on condenser is expected to come down, and if the design is done appropriately, the condensing pressures can also marginally reduce, leading to reduction in power consumption of compressors.

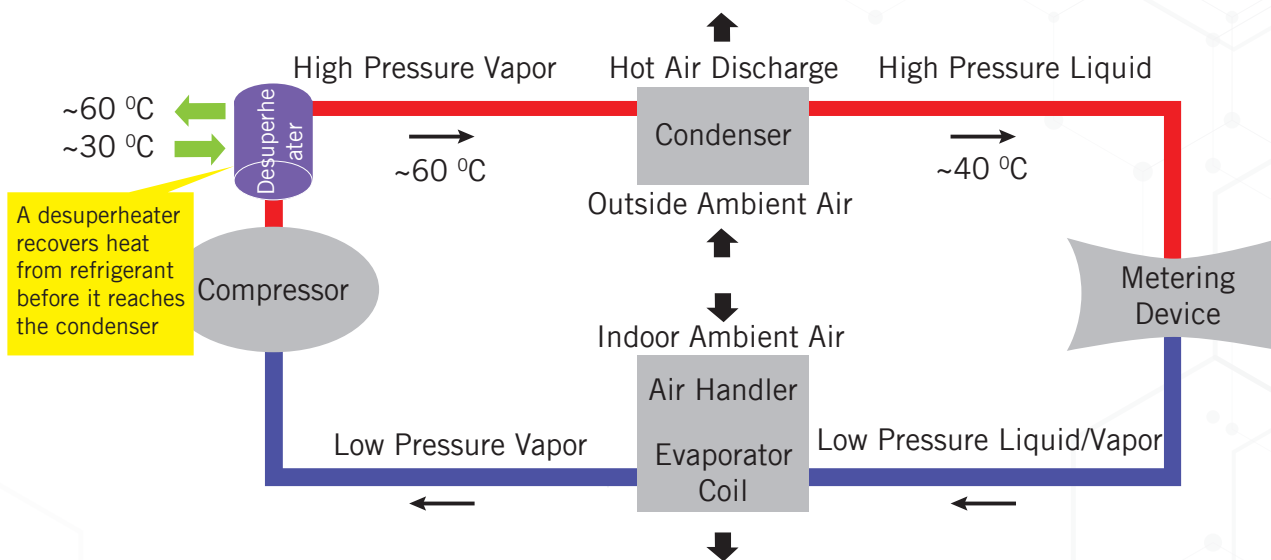

Figure 15: WHR from chiller compressor

De-superheater units are located between the compressor and condenser to utilize the high-temperature energy of the superheated refrigerant gas. By using a separate heat exchanger to utilize the high temperature of the discharge gas, it is possible to heat water to a higher temperature than would be possible in a condenser. Key technical parameters for the heat recovery system are given below:

Table 25: Key technical parameters of de super heater

Item	Value
Temperature of ammonia gas in/out	$100^\circ\text{C}/60^\circ\text{C}$
Temperature of water in/out	$30^\circ\text{C}/70^\circ\text{C}$
Amount of water that can be heated	294 litre/hr
Heat load recovered ³	16.4 kW

³ For 15kW of refrigeration load 6 kW heat recovery possible

Cost Benefit Analysis

The expected fuel savings to be achieved by installation of de-superheater is 9,655 litres of HSD annually. The annual monetary saving for this project is **INR 6.47 lakh, with an investment of INR 7.15 lakh, and a payback period of 13 months.**

Table 26: Cost Benefit Analysis – Installation of Desuperheater

Parameters	UOM	
Size of compressor	kW	55.875
Heat Recovery possible	kW	22.35
Heat Recovery possible	kJ/hr	80,420
Amount of hot water available for process (from 30 to 70°C)	litres per hour of water at 70°C	400
Hours of operation	hours per day	10
Days of operation	days per year	365
Cost of fuel	INR/litre	67
Calorific value	kJ/kg	45,187
Boiler efficiency	%	79%
Fuel Savings	litres/year	9,655
Annual Cost Savings	INR lakh	6.47
Investment	INR lakh	7.15
Payback period	months	13
IRR	%	116.52
NPV at 70% Debt (12% rate)	INR lakh	29.52

Energy & GHG Savings



Reference Plant Implementation

Table 27: Reference Plant Implementation - De-superheater

Project Name	Installation of De-Superheater
Objective	Installation of de-superheater to preheat boiler feed water from the superheated refrigerant gas.
Unit profile	Ernakulam Dairy, a unit under Ernakulam Regional Co-operative Milk Producers' Unions (ERCMPU) of MILMA, has its plant at Thrissur, Ernakulam, Kerala, and offers pasteurized Vitamin A-enriched milk and various milk-based products, such as butter, curd, ghee and Sambharam throughout the State.
Installation Photo	
Assumptions	<ul style="list-style-type: none"> ❖ Fuel Cost – INR 7/kg ❖ GCV – 18,409 kJ/kg ❖ Annual operating hrs - 5475 ❖ Feed water temperature – 30°C ❖ Boiler efficiency – 0.70
Savings (INR lakh)	₹ 5.08 lakh
Investment (INR lakh)	₹ 16 lakh
Simple Payback Period	36 months
Replication potential	In all the pharma units
Outcomes	<ul style="list-style-type: none"> ❖ 13.27 kg/hr of briquette saved ❖ Temperature of hot water achieved – 60°C ❖ 30.50 TOE of annual energy savings ❖ Increase in feed water temperature
Unit contact details	<p>Mr. Babu Varghese Milma Ernakulam Dairy Thrissur P.O. Ernakulam – 682101, Kerala Phone: 0484-2780103 Email: ernakulamdairy@yahoo.co.in</p>
Cluster Reference	Kerala Dairy Cluster

Vendor Details

Table 28: Vendor details – De-superheater for Compressors

Equipment Detail	De Super heater
Supplier Name	Promethean Energy Pvt Ltd
Address	Akshar Blue Chip IT Park, Turbhe MIDC, Turbhe, Navi Mumbai : 400706
Contact Person	Mr. Ashwin KP
Mail Id	ashwinkp@prometheanenergy.com
Phone No	+91 9167516848

4.2.3 kVAr Energy Compensator for Chiller Compressor

Baseline Scenario

The unit has installed three reciprocating chiller compressors of 60-TR capacity each for the chilled water requirement in the plant. During normal operation, two compressors are running continuously, and the third compressor runs based on demand. The table below shows the electrical parameters of chiller compressor:

Table 29: Electrical parameters

Compressor Name	Volt	Current	Power	PF
Chiller Compressor 1	407	119	73.1	0.87
Chiller Compressor 2	408	121	74	0.85

Both the compressors are running without VFD and operating at a PF of 0.86. The unit has installed a capacitor bank at the source for the central compensation of PF at the plant level. For induction motor to operate, it requires reactive current from the source for producing the magnetization effect. The more the reactive current drawn from the supply, the higher will be the distribution losses across the feeder. It is always better to provide the reactive current locally to reduce the distribution losses in the plant.

Proposed System

It is recommended to install a reactive current injector locally near to the load end to reduce the reactive current drawn from the supply. An innovative product called kVAr compensator can be installed near to load end to improve the PF of motor and thereby reduce the magnetization current drawn from supply. The kVAr compensator works by reclaiming, storing and then supplying locally the reactive power element of electricity to inductive motors and loads. As the electrical equipment operates, this reactive power is 'pulled and pushed' to and from the kVAr compensator by the motor. Reactive power is then recycled by the kVAr compensator which can supply it on the spot without having to draw it from the grid. This leads to reduction in electric demand and improvement in the power factor and thus, the operating costs.

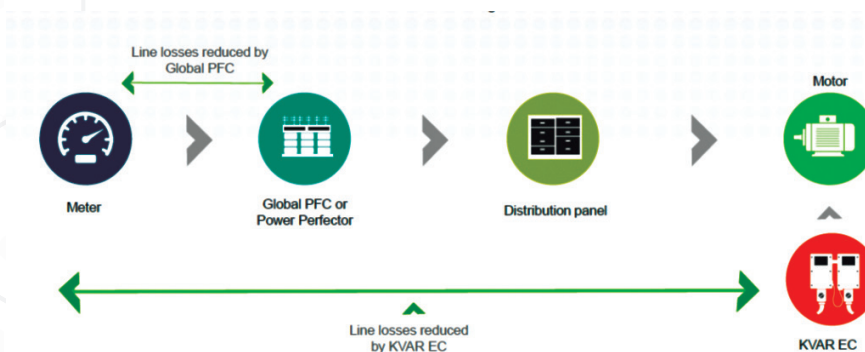

Figure 16: kVAr energy compensator

From a technical point of view this is the best solution, as the reactive energy is produced at the point where it is consumed. Heat distribution losses (I²R) are therefore reduced in all the lines, resulting in real power reduction. The kVAr required for the motor to maintain the PF close to unity is found out by using a sizing kit. It helps in fixing and selecting the correct size of kVAr unit required to make the inductive load work in the most efficient way.

Merits

- ❖ Reduced distribution losses across the infrastructure that translates into cost savings.
- ❖ Reduced kW remand charge; the motor draws and frees capacity in the electric distribution system, frees up extra space in supply panel.
- ❖ Improved voltage regulation and phase imbalance due to reduced voltage drop.
- ❖ Reduced operating cost of machinery.
- ❖ Improved Power Factor of Induction Motor.
- ❖ Works on all line-start and soft-start inductive loads such as motors, compressors, pumps, chillers, fans, blowers, etc.
- ❖ Customized unit built for each load after real-time monitoring and testing procedures.

Demerits

- ❖ Not suitable for chillers with VFD.

Cost Benefit Analysis

The expected electricity savings to be achieved by installation of kVAr compensator is 46,570 units annually. The annual monetary saving for this project is **INR 2.56 lakh, with an investment of INR 4.20 lakh, and a payback period of 20 months.**

Table 30: Cost Benefit Analysis – kVAr Energy Compensator

Parameters	UOM	Value
Total power consumption of chiller	kW	147
Guaranteed power savings	%	4
Power savings	kW	5.88
Operating hrs	hrs	24
Operating days	Days	330
Electricity Price	INR/kWh	6.00
Annual electricity savings	kWh	46,570
Annual cost savings	INR lakh	2.56
Investment	INR lakh	4.20

Parameters	UOM	Value
Payback period	Months	20
IRR	%	83.57
NPV at 70 % Debt (12% rate)	INR lakh	11.06

Energy & GHG Savings



Reference Plant Implementation

Table 31: Reference Plant Implementation – kVAr Compensator

Project Name	Installation of kVAr Compensator
Objective	Installation of kVAr compensator to reduce the energy losses.
Installation Photo	
Assumptions	<ul style="list-style-type: none"> ❖ Electricity Cost – INR 6.65 /kWh ❖ Operating hrs – 20 hrs/day
Savings (INR lakh)	₹ 1.22
Investment (INR lakh)	₹ 1.01
Simple Payback Period	10 months
Replication potential	In all the pharma units having chiller compressor without VFD
Outcomes	<ul style="list-style-type: none"> ❖ Annual electricity savings – 18,496 ❖ Improvement in PF
Unit contact details	Mr. D. Manikyala Rao, Neuland Labs Ltd.
Cluster Reference	Hyderabad Pharma Cluster

Vendor Details

Table 32: Vendor Details – kVAr Energy Compensator

Equipment Detail	kVAr Energy Compensator
Supplier Name	Athena Cleantech
Address	1904, Haware Infotech Park, Sector 30A, Vashi, Navi Mumbai
Contact Person	Mr. Sanjeev Reddy
Mail Id	sanjeev@cleantech.com.sg
Phone No	+91 9440259863.

4.2.4 VFD for Chilled Water Pumps

Baseline Scenario

The unit has installed four chilled water pumps of 10 HP each for pumping chilled water to process. During normal operation, three pumps are in operation. The flow requirement to different processes varies in the range of 1,000 to 2,500 LPH. The chilled water is used in different processes, and After the process the return water is coming in at 6°C to 8°C. The figure below shows the schematic of chilled water system in the plant.

The total discharge line from the pumping system is of 180 mm dia over a required length up to 500 m, and hence the line losses are not so high. The existing layout is shown below:

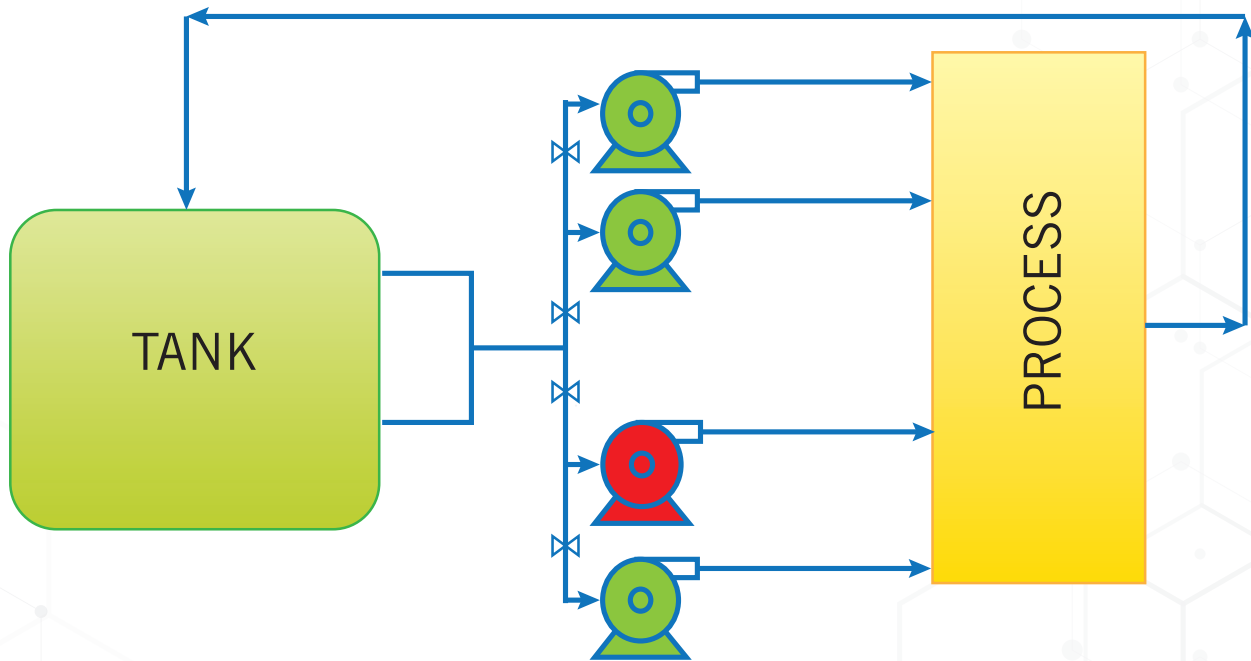

Figure 17: Existing pumping layout

The current operating practice in the plant is to operate the pumps such that the discharge pressure of 2 kg/cm² is available and the maximum flow of 2,500 LPM is maintained. For these required conditions, one pump operates at its full load operating conditions and the other two pumps are manually controlled for the required pressure and flow conditions.

Proposed System

The best possible solution for this condition is to install VFD in one of the pumps & operate the other two pumps in fully open conditions. The required system pressure will be given as feedback to the VFD based on which the required flow can be obtained. The overall savings here will be in terms of higher operating efficiency of one pump & lower RPM for the operation of the third pump.

The pump with VFD will also ensure minimum recirculation under conditions when the system is under no-load condition.

Merits

- ❖ Higher operating efficiencies.
- ❖ Reduced power consumption.
- ❖ Optimum flow & head.

Limitations

- ❖ Higher installation costs.
- ❖ May require system stoppage during installation.

Cost Benefit Analysis

The expected electricity savings to be achieved by installation of VFD for chilled water pump is 24,000 units annually. The annual monetary saving for this project is **INR 0.96 lakh, with an investment of INR 0.50 lakh, and a payback period of 06 months.**

Table 33: Cost Benefit Analysis – VFD for chilled water pump

Parameters	UOM	Present	Proposed
Power Consumption	kW	22	18
Flow	LPM	1,000 – 2,500	1,000 – 2,500
Head	m	30	25
Overall Efficiency	%	65	72
Power Savings	kW		4
Electricity Cost	INR/kWh		4
Operating hrs	hrs/day		20
Energy Savings	kWh		24,000
Cost Savings	INR lakh		0.96
Investment	INR lakh		0.50
Payback period	Months		6
IRR	%		4.64
NPV at 70 % Debt (@ 12% rate)	INR lakh		222.60

Energy & GHG Savings



Reference Plant Implementation

Table 34: Reference Plant Implementation – VFD for chilled water pump

Project Name	VFD for chilled water pump
Objective	Replaced old system for chilled water circulation containing one 10 hp pump and one 15 hp pump with a new VFD controlled pumping system in which one 7.5 hp pump is directly coupled with VFD and four other pumps of 7.5 hp each are used to get the required rate of flow.
Unit Profile	Kozhikode Dairy under MRCMPU Ltd has an average daily procurement of 6 Lakh L of raw milk, with an average daily sale of 5 Lakh L of processed milk. Other products include Curd, Ghee, Peda, Butter, Butter milk, Ice cream, Palada, Burfi, etc.
Installation Photo	
Assumptions	<ul style="list-style-type: none"> ❖ Electricity Cost – INR 5.50 /kWh ❖ Operating hrs – 20 hrs/day
Savings (INR lakh)	₹ 2.45 lakh
Investment (INR lakh)	₹ 19.42 lakh
Simple Payback Period	97 months
Replication potential	In all the pharma units
Outcomes	<ul style="list-style-type: none"> ❖ Annual electricity savings – 44,712 ❖ Smooth control of pumps
Unit contact details	Mr. Shaji Mon Dairy Manager Kozhikode Dairy, MRCMPU region Mail Id : kkddairy@malabarmilma.coop Phone No : 04952800331
Cluster Reference	Kerala Cluster

Vendor Details

Table 35: Vendor Details – VFD for chilled water pump

Equipment Detail	VFD for chilled water pump
Supplier Name	Danfoss Industries Ltd
Address	703, 7 th Floor, Kaivanya Complex, Near Panchwati Cross Road, Ambawadi, Ahmedabad
Contact Person	Mr. Srihari Vyas
Mail Id	Shrihari@danfoss.com
Phone No	9825024991

4.2.5 Evaporative Condenser

Baseline Scenario

The unit has installed two chiller compressors of 180 hp and 150 hp with 100 TR capacity each for chilled water requirement in the plant. In a refrigeration cycle, when the compressor runs, the refrigerant starts flowing through the system. The compressor continuously sucks low pressure, low temperature refrigerant vapours from the evaporator and pump it to condenser at high pressure and temperature. While flowing through the condenser, the high temperature vapours release their heat to atmosphere and condense to high pressure liquid state. After condenser this high-pressure liquid enters the expansion valve where it is throttled to low pressure. On throttling the pressure and temperature of refrigerant decreases and when this low pressure, low temperature throttled liquid flows through evaporator, it sucks heat and produce cooling. On absorbing heat in evaporator all the low-pressure liquid evaporates to low-pressure, low-temperature vapours, which are again sucked by compressor. In this way all these processes go on continuously and as long as the compressor runs, the system produces cooling around the evaporator. The unit has installed a PHE condenser for 180 hp Chiller and a shell & tube condenser for 150 hp Chiller and both the system have open cooling tower arrangement for the refrigeration system. The schematic of existing condenser system is given below:

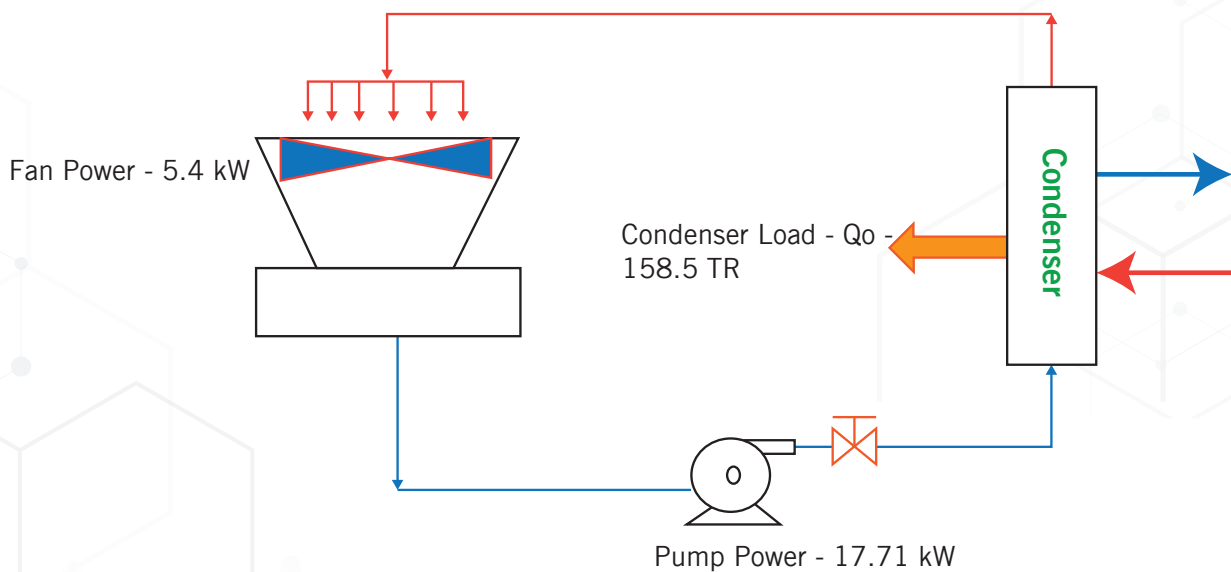

Figure 18: Existing Condenser System

The plant is having a normal PHE condenser with cooling tower arrangement for the 180 hp chiller. The compressor is running at 40°C condensing temperature and -2°C evaporation temperature. As the current system has separate PHE condenser and CT, the auxiliary loads are on the higher side and the water quality can affect the condenser performance due to scaling and fouling. This can result in increased power consumption of chiller compressor. During the study it was also found that condensing temperature was on the higher side. Lower the condensing temperature better the performance of chiller compressor. The following table shows the power consumption of existing system.

Table 36: Existing Parameter – Refrigeration Systems

Sr. No.	Parameter	UOM	
1	Chiller Compressor	kW	103
2	Condenser Pump	kW	17.71
3	Cooling Tower Fan Power	kW	5.4

Proposed System

It is recommended to replace the existing PHE condenser with evaporative condenser.

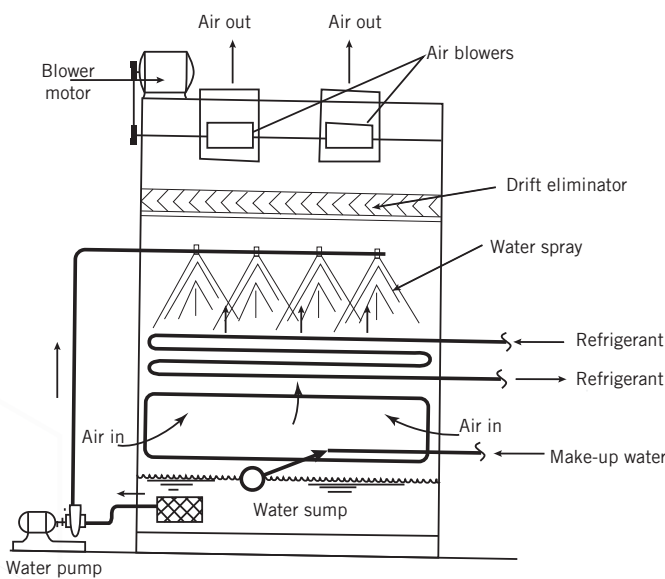

Figure 19: Evaporative Condenser

Evaporative condensers combine the features of a cooling tower and water-cooled condenser in a single unit. In these condensers, the water is sprayed from top part on a bank of tubes carrying the refrigerant and air is induced upwards. There is a thin water film around the condenser tubes from which evaporative cooling takes place.

In evaporative condenser, the vapour to be condensed is circulated through a condensing coil, which is continually wetted on the outside by a recirculating water system. Air is pulled over the

coil, causing a small portion of the recirculating water to evaporate.

The evaporation removes heat from the vapour in the coil, causing it to condense. The heat transfer coefficient for evaporative cooling is very large. Hence, the refrigeration system can be operated at low condensing temperatures (about 11 to 13°C above the wet bulb temperature of air). The water spray counter current to the airflow acts as cooling tower. The role of air is primarily to increase the rate of evaporation of water. The required air flow rates are in the range of 350 to 500 m³/h per TR of refrigeration capacity.

With the installation of evaporative condenser, condensing temperature of 36°C can be achieved for the same cooling capacity. As a result, the compressor power will come down drastically at 4°C lower condensing temperature compared to existing condensing temperature of 40°C.

Merits

- ❖ Reduces fouling tendency.
- ❖ The air and water flow in a parallel path.

- ❖ Increased water flow over the coil.
- ❖ Evaporative cooling in the fill.
- ❖ Colder spray water.

Demerits

- ❖ High upfront cost.
- ❖ Requires system modification.

Cost Benefit Analysis

The expected electricity savings to be achieved by installation of evaporative condenser is INR 1.98 Lakh units annually. The annual monetary saving for this project is **INR 13.07 lakh, with an investment of INR 29.52 lakh, and a payback period of 27 months.**

Table 37: Cost Benefit Analysis – Evaporative Condenser

Parameters	UOM	
Existing System - Measured		
Chiller Compressor Rating	kW	132.3
Power Consumption	kW	103
Evaporator Temperature	°C	-2
Condensing Temperature	°C	40
Condenser Heat Load Qo	TR	158.5
Condenser Pump Power	kW	17.71
Cooling Tower Fan Power	kW	5.4
Proposed System		
Design of new condenser with 25% safety margin	TR	198.12
Evaporative Condenser Model available	TR	200
Evaporative Condenser Fan Power	kW	5.5
Evaporative Condenser Pump Power	kW	4
Energy Savings		
Total Auxiliary Power of Existing Condenser	kW	23.11
Total Auxiliary Power of Evaporative Condenser	kW	9.5
Savings in Auxiliary Power	kW	13.61
Current Compressor Power @ 40°C condenser temperature	kW	103

Parameters	UOM	
Compressor Power @ 36°C condenser temperature (with installation of Evaporative Condenser)	kW	94
Savings in Compressor Power due to reduction in condenser temperature	kW	9
Total Savings	kW	22.61
Power Cost	INR/kWh	6.6
Operating Hours	hrs/day	24
No of Days	Days/year	365
Annual Energy Savings	kWh	1,98,129
Annual Cost Savings	INR lakh	13.07
Investment for 200 TR evaporative condenser	INR lakh	29.52
Payback period	months	27
IRR	%	63.79
NPV at 70 % Debt (12% rate)	INR Lakh	52.75

Energy & GHG Savings



Vendor Details

Table 38: Vendor Details – Evaporative Condenser

Equipment Detail	Evaporative Condenser
Supplier 1	
Supplier Name	VINI Enterprise
Address	13, Nutan Patidar Society, Vallabhwadi, Maninagar, Ahmedabad-380008.
Contact Person	Mr. Saurin Dave
Mail Id	saurin@vinienterprise.com
Phone No	+91 97270 12111
Supplier 2	
Supplier Name	Frick India Ltd
Address	3rd Floor, Tiecicon House, Dr. E Moses Road, Jacob Circle, Dr E Moses Rd, Lower Parel, Mumbai
Contact Person	Mr Mohan Garud
Mail Id	mumbai@frickmail.com
Phone No	+91 9833994591

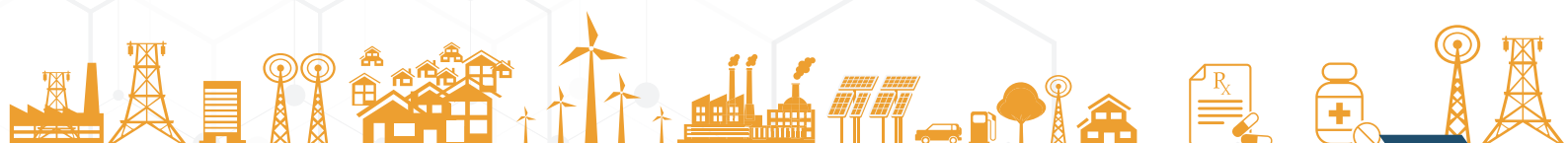

4.2.6 Electronically Commutated Motors for AHUs

Baseline Scenario

Air handling units are installed in the plant and the efficiency of these low capacity fans is at a reasonable range. The latest technology for AHUs is to replace existing motors with energy efficient servo motors with permanent magnet-based system. This system comes with a speed control.

The motors are operated at a loading of around 40-60%. As the motors are operated at loading below the rated value it is likely to give low efficiency and operate at a lower power factor. There is a potential of increasing the efficiency of the motor in the range of 4-6% by replacing the existing ones with the new energy efficient motors.

Proposed System

Using EE fans with servo motor-based system comes with a speed control system. The savings which can be achieved by using servo motors with EE fans is 25-30%. The type of motor is not critical to a servomotor and different types may be used. At the simplest, brushed permanent magnet DC motors are used. Energy Efficient fans come as a complete package with servo motors and marginal increase in efficiency of fans can be expected. Major energy savings is from replacement of motors and even under part load operation energy savings of 20% can be expected.



Figure 20: EC Fan

Following are the advantages of using servo motors:

- ❖ Smooth rotation at low speeds: Brush motors are available, specially designed for low speed smoothness with many commutator segments. Brushed motors are the smoothest of the three discussed motor technologies.
- ❖ Low cost drive: A DC brush drive can be made very economical, since only a single bridge circuit is required.
- ❖ No power used at standstill: With no static loads on the motor, any current is required to hold position.
- ❖ High peak torque available: In intermittent duty applications, particularly when positioning mainly inertial loads, the motor can be overdriven beyond its continuous rating.
- ❖ Flat speed-torque curve: Gives optimum performance with easily generated linear acceleration ramps.
- ❖ Wide variety of types available: Brush motors are produced in many styles including very low inertia types for high dynamic applications.

Merits

- ❖ Low power consumption.
- ❖ No pulley losses.
- ❖ Smooth control of operation.

Demerits

- ❖ High upfront cost.
- ❖ Requires system modification.

Sectors Applicable

- ❖ Pharma

Cost Benefit Analysis

The expected electricity savings to be achieved by installation of EC fans is 0.41 Lakh units annually. The annual monetary saving for this project is **INR 2.58 lakh, with an investment of INR 4.00 lakh, and a payback period of 18 months.**

Table 39: Cost benefit analysis: EC fans for AHUs

Parameters	UOM	Value
Total no of fans to be replaced	Nos	3
Total power consumption of AHU	kW	19
Percentage energy savings	%	30
Power savings	kW	5.7
Annual operating hours	hrs	7,200
Annual energy savings	kWh	41,040
Power cost	INR/kWh	6.30
Annual savings	INR lakh	2.58
Investment	INR lakh	4.00
Payback period	months	18
IRR	%	87.59
NPV at 70 % Debt (12% rate)	INR lakh	11.24

Energy & GHG Savings

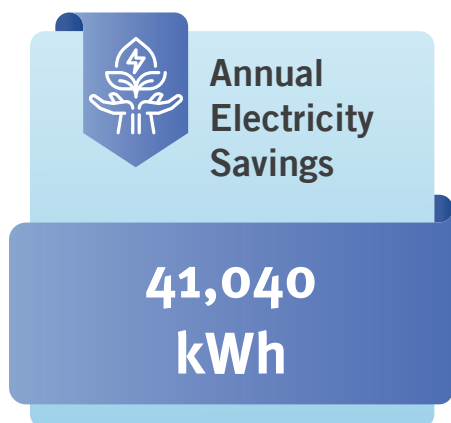

Reference Plant Implementation

Table 40: Reference plant implementation - EC blowers for AHUs

Project Name	EC blowers for AHUs
Objective	Upgraded air handling unit existing conventional blower by EC blowers and achieved 35 to 40% energy saving
Unit Profile	Products include Generic Formulations, including Tablets, Capsules, Injectables, and Topical creams and also making products across the major therapeutic areas of gastrointestinal ailments, cardiovascular disease, pain management, oncology, anti-infective, paediatrics and dermatology
Assumptions	❖ Electricity Cost – INR 6.70/ kWh
Savings (INR lakh)	₹ 14.00
Investment (INR lakh)	₹ 42.00
Simple Payback Period	36 months
Replication potential	In all the pharma units
Outcomes	<ul style="list-style-type: none"> ❖ Annual electricity savings – 21,52,317 units ❖ Noise level maintained at less than 65 db, which is 23% less than existing belt-driven system ❖ Reduction in cooling requirements helps improve efficiency
Unit contact details	Mr. Manish Kothari Dr Reddy's Laboratories Ltd., FTO Unit-2, Bachupally, Hyderabad Mail Id: manishkothari@drreddys.com Phone No: 9100787425
Cluster Reference	Hyderabad Pharma Cluster

Vendor Details

Table 41: Vendor Details – EC fans

Equipment Detail	EC Fans
Supplier 1	
Supplier Name	AAD TECH INDIA PRIVATE LIMITED
Address	21, Papa Industrial Estate, 40 Suren Road, Andheri East, Mumbai
Contact Person	Mr. Manpreet Singh
Mail Id	manpreet@aadtech.in
Phone No	+91 9876724003

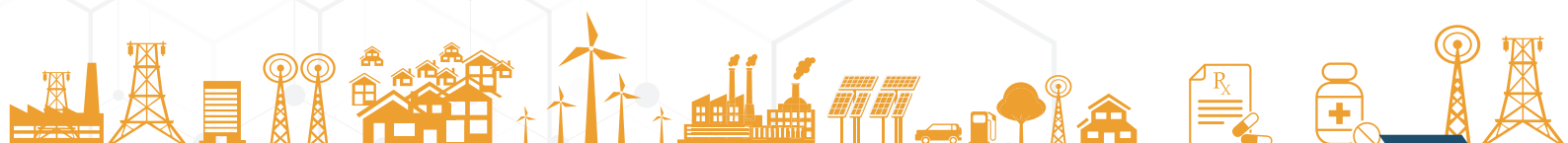

4.2.7 Online Condenser Cleaning System

Baseline Scenario

The condenser water at chiller has a TDS of 2,000 ppm. The plant team is following a cleaning procedure on condensers once every three months. During this period the compressor power consumption increases to a higher level and fluctuates between the minimum and maximum values. There is a good potential for installing an online condenser cleaning system in AHUs and improving the heat transfer in the condenser.

The cooling water temperature from the cooling tower is at 30°C, whereas the cooling water temperature is 7°C more than the wet bulb temperature. The condenser temperature of the chiller was observed to be at a temperature above 40°C. The standard operating temperature should consist of a very low degree of superheat for the chiller condenser system and should be maintained less than 38°C. There is a good potential to reduce the condensing temperature and superheat of the refrigerant by installing an online condenser cleaning system

Proposed System

It is recommended to install online condenser cleaning system to improve the performance of condenser. The online condenser cleaning system consists of sponge balls which go into the heat exchanger. The dirt in the system is removed by injection of these balls. A ball trap removes the balls and is collected and refreshed (cleaned) making it ready for use again. All the balls will not go into all the tubes in the system and thus online ball cleaning system will not be a substitute for standard condenser cleaning practiced by the plant. As the operating temperature of refrigerant is lowered, the condenser pressure of refrigerant will be lowered, in turn reducing the power consumed by the compressor. About 4% of energy consumption of the chiller will be reduced due to 2°C reduction at refrigerant temperature at the outlet of the condenser.

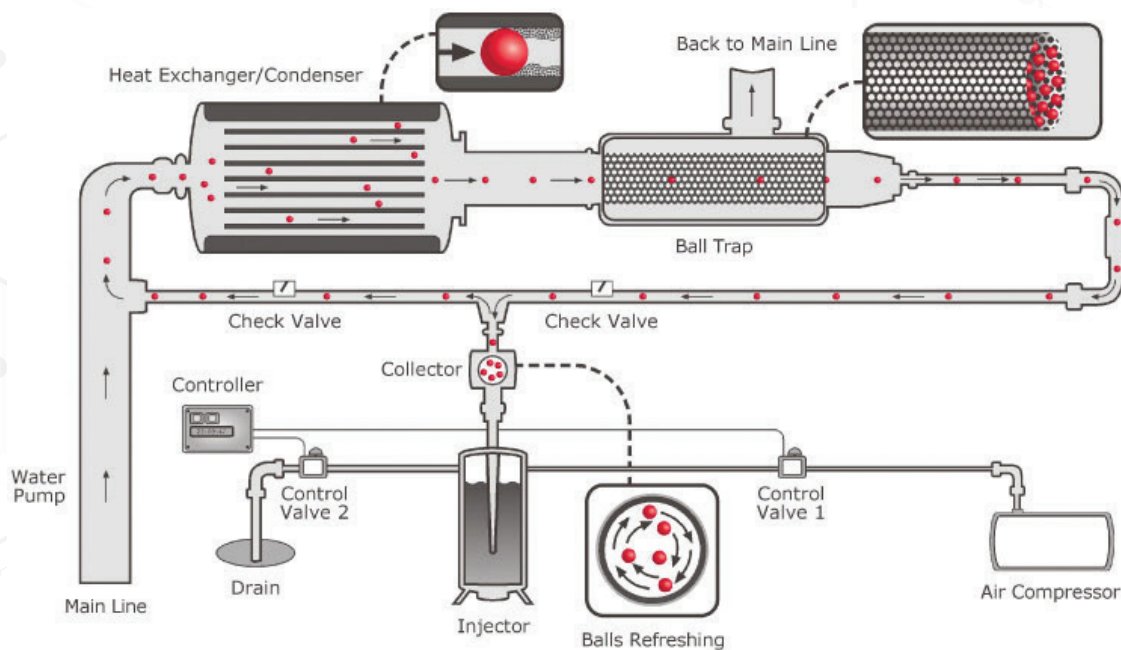

Figure 21: Schematic of Online Condenser Cleaning System

Merits

- ❖ Reduced power consumption of compressor.
- ❖ No fouling.
- ❖ Reliability.

Limitations

- ❖ High upfront cost.
- ❖ Maintenance issues.
- ❖ Space constraints.

Sectors Applicable

- ❖ Pharma

Cost Benefit Analysis

The expected savings by installation of online condenser cleaning system is 24,156 units annually. The annual monetary saving for this project is **INR 1.52 lakh, with an investment of INR 4.50 lakh, and a payback period of 35 months.**

Table 42: Cost Benefit Analysis – Online condenser cleaning system

Parameters	UOM	Value
Condenser cooling water temperature	°C	30
Reduction in refrigerant discharge temperature possible	°C	3
Chiller power consumption	kW	61
For every 1°C reduction in condenser cooling temperature 4% energy saving can be obtained		
% Power savings	%	12
Power savings	kW	7.32
Annual operating hours	hrs	3,300
Annual energy savings	kWh	24,156
Power cost	INR/kWh	6.30
Annual savings	INR lakh	1.52
Investment	INR lakh	4.50
Payback period	months	35
IRR	%	50.46
NPV at 70 % Debt (12% rate)	INR lakh	5.65

Energy & GHG Savings



Reference Plant Implementation

Table 43: Reference plant implementation - Online Condenser Tube Cleaning System

Project Name	Online Condenser Tube Cleaning System
Objective	Condenser Tube cleaning system installation in Heat Pump to maintain condenser approach temperature and achieved 5% energy saving
Unit Profile	Mylan laboratories Unit 8 is located at Vizianagaram and it produces Active Pharmaceutical Ingredients with a plant capacity of 1,198 kl
Installation Photo	
Assumptions	❖ Electricity Cost – INR 5.80 /kWh
Savings (INR lakh)	₹ 90.00
Investment (INR lakh)	₹ 100.00
Simple Payback Period	13 months
Replication potential	In all the pharma units
Outcomes	<ul style="list-style-type: none"> ❖ Annual electricity savings – 15,00,000 units ❖ Up to 15% energy savings in Water cooled chillers. ❖ Single System for Multiple Chillers
Unit contact details	<p>Mr. G L Srinivas Mylan Laboratories Limited – Unit 8 G. Chodavaram Village, Pusapatirega Mandal, Vizianagaram Dist, A.P Email: srinivas.ghattamaneni@mylan.in</p>
Cluster Reference	Andhra Pradesh

Vendor Details

Table 44: Vendor Details – Online Condenser Cleaning System

Equipment Detail	Online Condenser Cleaning System
Supplier 1	
Supplier Name	CET Enviro
Address	FF-26, Omaxe Square, Jasola, New Delhi
Contact Person	Mr. Ashish Sharma
Email Id	aashish.s@cet-enviro.com
Phone No	9826079408

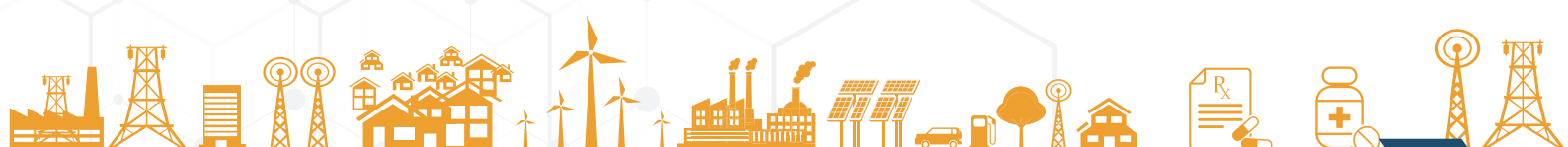

4.2.8 Replace three port with two-port valves in AHUs and install VFD for chilled water pump

Baseline Scenario

The 3-element valve controls the amount of chilled water entering the respective AHU. AHUs are fitted with temperature controllers. Once the desirable temperature is achieved in the conditioned space, the 3-element valve bypasses the chilled water entering the AHU, therefore avoiding overcooling.

This operation of bypassing the AHUs continues for a certain time and when the temperature of the conditioned space increases, the position of the 3-element control valve changes and water is let towards the AHU. Though this helps in maintaining the desired temperature of the conditioned space and avoids overcooling, the pumping power in a 3-element control does not change irrespective of the temperature. There is a good potential to replace the 3-element control with 2-element control in the AHUs and install a VFD for the chilled water pump, hence reducing the pumping power of chilled water pumps.

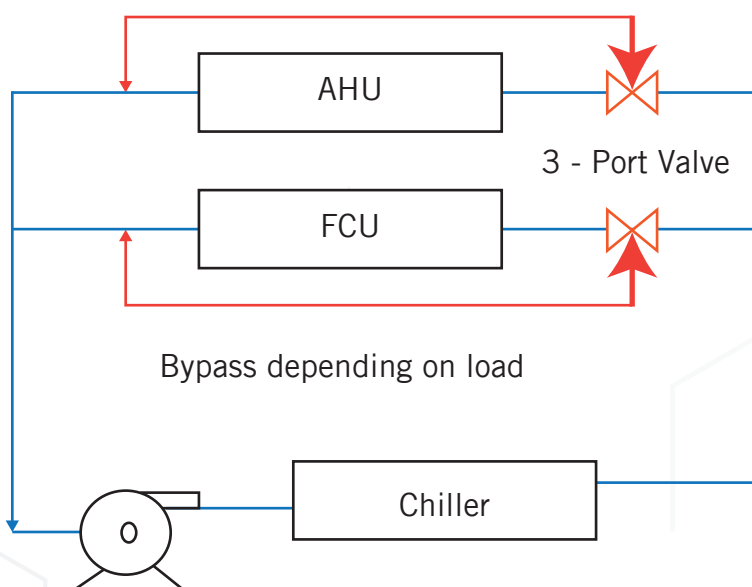

Figure 22: Three element control for AHUs

Proposed System

Another way of controlling the chilled water flow to individual users is by using two-way valve in place of three-way valve. In this case, bypass operation is avoided and quantity of chilled water required through the AHU is optimized. Additional recirculation line must be provided by passing the AHU users in order to avoid icing in the pipeline. Chilled water is either let in or rejected based on the temperature setting. Through this operation, the pumping energy can be optimized by installing a variable frequency drive for the chilled water pumps with discharge pressure of the AHU as the feedback signal. This will save the pumping power of the secondary pump. It is required to blind the bypass line and modify three-way valves to two-way valves and install VFD for chilled water pumps with back pressure as feedback.

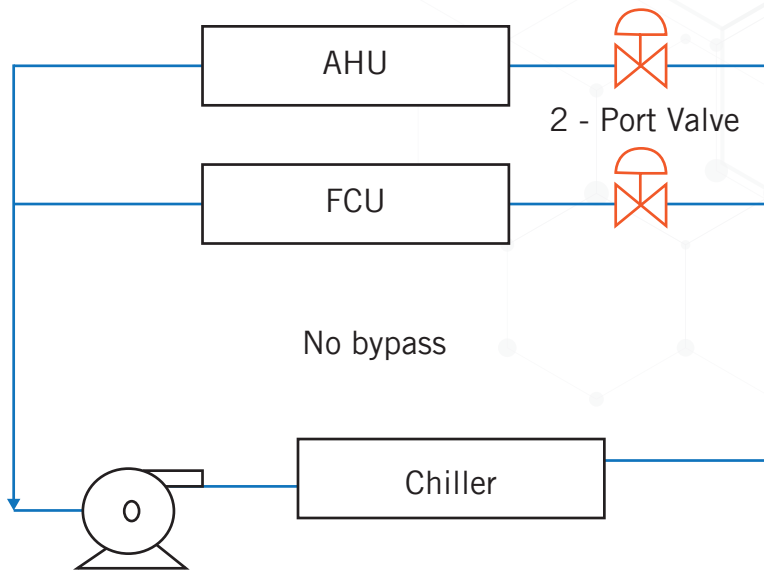

Figure 23: Two port control for AHUs

Merits

- ❖ Ease of operation.
- ❖ Better cooling and precise control of pumps.

Limitations

- ❖ Upfront cost.
- ❖ System modification.

Cost Benefit Analysis

The expected savings by installation of two-port valves with VFD for chilled water pump is 1,8247 units annually. The annual monetary saving for this project is **INR 0.35 lakh, with an investment of INR 0.70 lakh and a payback period of 24 months.**

Table 45: Cost benefit analysis - Two port system for AHUs

Parameters	UOM	Value
Power consumed by secondary chilled water pump	kW	10
% Power savings with two port control and with VFD	%	20
Power savings	kW	2.00
Annual operating hours	hrs	3,300
Annual energy savings	kWh	6,600
Power cost	INR/kWh	6.30
Annual savings	INR lakh	0.42

Parameters	UOM	Value
Investment	INR lakh	0.70
Payback period	months	20
IRR	%	81.74
NPV at 70 % Debt (12% rate)	INR lakh	1.79

Energy & GHG Savings



Vendor Details

Table 46: Vendor Details – VFD for Chilled water pump

Equipment Detail	VFD and two port system
Supplier 1	
Supplier Name	Danfoss Industries Ltd
Address	703,7th Floor, Kaivanya Complex, Near Panchwati Cross Road, Ambawadi, Ahmedabad
Contact Person	Mr. Srihari Vyas
Email Id	Shrihari@danfoss.com

4.2.9 Active refrigerant agent addition in lube oil for chillers

Baseline Scenario

The plant has a 310 TR, R134a refrigerant-based Trane water-cooled chiller for catering to the cooling requirements. Average energy consumption per ton of refrigeration was found around 0.501. It is also observed that there is frequent fouling of heat exchanger tubes due to oil. Generally, during the piston stroke in the cylinder of a compressor, the refrigerant gets a small amount of oil from the compressor, which over time adheres to the inner pipe of the evaporator. That adhesion oil acts as an insulator reducing the heat transfer capacity of the evaporator. Typically, an AC's efficiency deterioration will be more than 30% for a 20-year-old system. Most air conditioning and refrigeration systems have a mechanical compressor which relies on lubricating oil to function during the normal course of the refrigeration process, 0.5% to 8% of the compressor's lubricating oil is circulated throughout the system along with the refrigerant. The oil fouling arises because the compressor oil builds up on the metallic walls of the refrigeration tubing, reducing the heat transfer from the refrigerant to the walls of the refrigerant tubing.

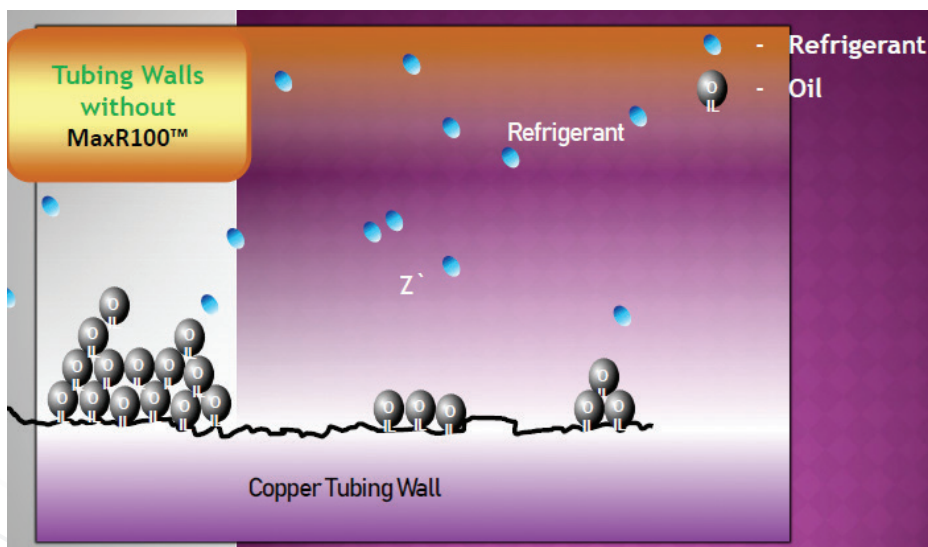
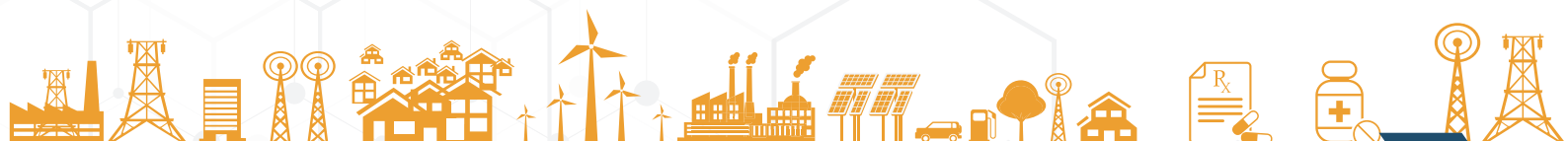

Figure 24: Oil coagulating inside copper tube

Proposed System

It is recommended to use active refrigerant agent, which is an intermetallic compound technology which, when introduced into the refrigerant oil, forms a permanent bond to metal surfaces which removes oil fouling, changes the thermal nature of the metal and lowers the boiling point of the refrigerant gas, resulting in a more efficient operating system with substantial energy cost savings.

The thermal transfer efficiency loss can be resolved by a non-invasive synthetic refrigerant additive compound that defeats and releases the surface tension forces. It is this Van der Waals force that causes the compressor oil globules to adhere to each other and then to refrigerant tubing walls, forming the oil fouling. Such an additive can defeat the surface tension by tightly bonding to the metal surfaces in a layer that is one molecule thick and



thereby prevent the recurrence of oil contamination on the heat transfer surfaces. The release of the oil contamination restores the lost 20% to 30% thermal transfer efficiency. An added benefit is that the capillary tubes and expansion valves are also cleaned and protected from future fouling.

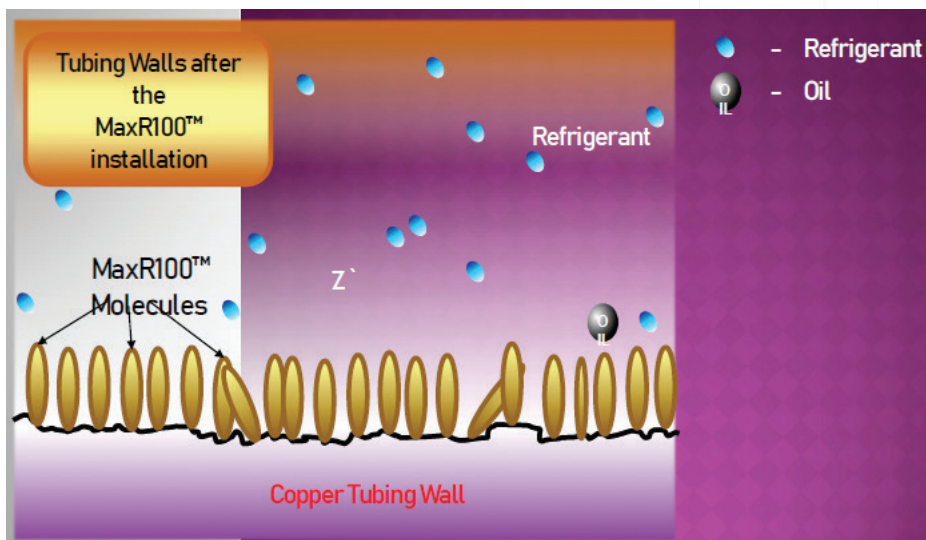

Figure 25: Protective layer formation

Active refrigerant agent does the re-conditioning, restoring and maintaining efficiency of the air conditioners, chillers and cooling systems, resulting in reduced kWh consumption. This action removes oil contamination, changes the nature of the metal and reduces thermal boiling point of the refrigerant gas, which results in a more efficient system operation with a substantial saving in energy costs. The agent forms a protective molecular layer that does not change the mechanical tolerances and does not contaminate existing lube oil.

Merits

- ❖ Does not affect the equipment warranty.
- ❖ RoI of less than 12 months.
- ❖ Copper corrosion resistance.

Limitations

- ❖ System modification.

Cost Benefit Analysis

The expected savings by active refrigerant agent is 1,71,600 units annually. The annual monetary saving for this project is INR 10.81 lakh, with an investment of **INR 8.00 lakh and a payback period of 09 months.**

Table 47: Cost benefit analysis - Active refrigerant agent

Parameters	UOM	Value
Chiller power consumption	kW	143
% Power savings	%	20
Power savings	kW	28.60
Annual operating hours	hrs	6,000
Annual energy savings	kWh	1,71,600
Power cost	INR/kWh	6.30
Annual savings	INR lakh	10.81
Investment	INR lakh	8.00
Payback period	Months	09
IRR	%	163.78
NPV at 70 % Debt (12% rate)	INR lakh	51.12

Energy & GHG Savings



Vendor Details

Table 48: Vendor Details – Active refrigerant agent

Equipment Detail	Active Refrigerant Agent
Supplier Name	Amnyk India
Address	40, Bank Street, Khatau Building, Ground Floor, Mumbai
Contact Person	Mr. B Sureshwar
Email Id	bs@amnyk.com
Phone No	9246340166

4.2.10 Optimize Chilled Water Pumping System

Baseline Scenario

The current system consists of a primary and secondary pump. Primary pump transfers hot well water collected from process to the chiller. The secondary pump transfers cold well water collected from chiller to the process. The chilled water consumers in the plant are air handling units and reactors. The schematic layout of current system is shown below:

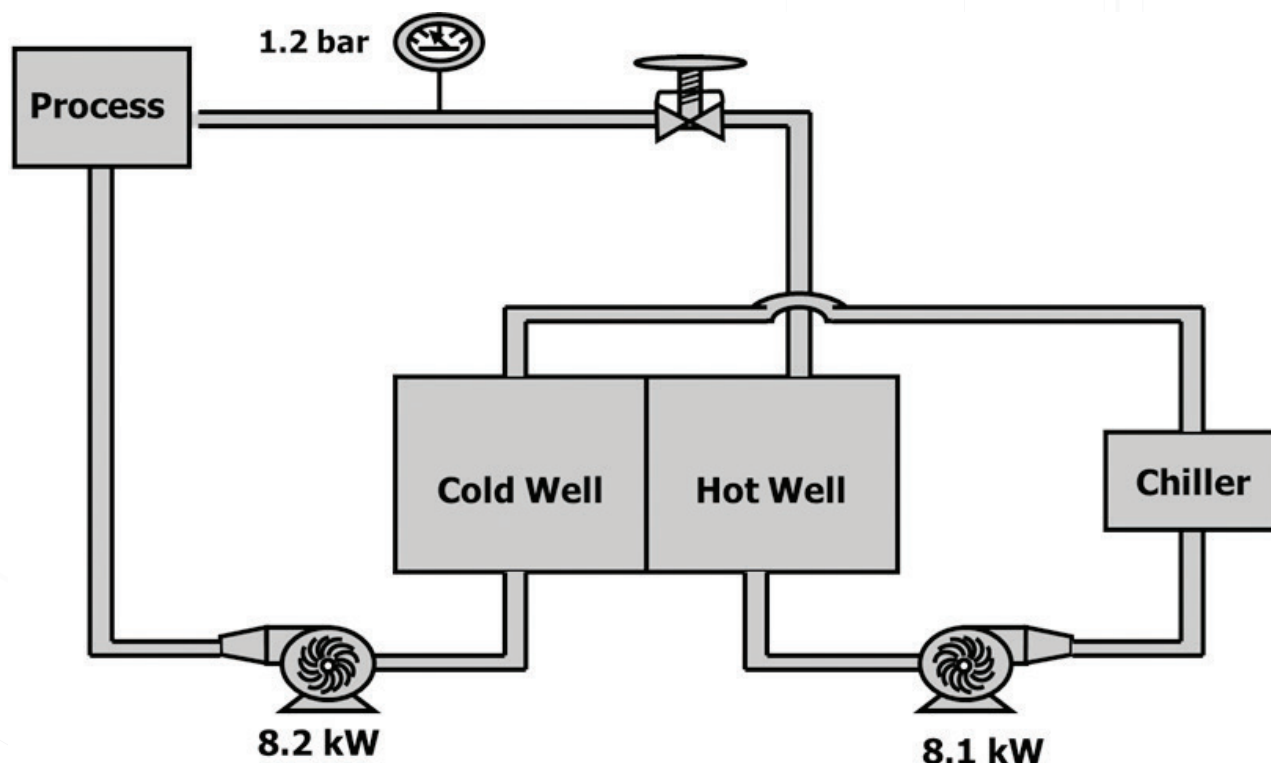

Figure 26: Present pumping system

Proposed System

Latest technology of chilled water pumping system consists of a single pump to pump through the chiller and the process. There is a good potential to convert the existing system to an energy efficient single pumping system. The pressure drop found across the chiller was 0.4 kg/cm^2 . The pressure requirement can be designed based on pressure drop across the system.

The TDS of the water was found to be more than 1,500 ppm. The recommended level for chilled water pumping system should be less than 300 ppm. The condenser water should be maintained below 1,500 ppm. High ppm was observed as the blowdown requirement was to be met. The following calculation mentioned below can be used for blowdown of cooling towers.

Blow down quantity = Evaporation Losses

COC - 1

Cycles of concentration (COC) = $\frac{\text{Total dissolved solids in Circulating water}}{\text{Total dissolved solids in Makeup water}}$

Evaporation Loss (m³/hr) = $0.00085 \times 1.8 \times \text{circulation rate (m}^3/\text{hr)} \times (T_1 - T_2)$

(T₁ - T₂) - Temperature difference between inlet and outlet water

The recommended cycle of concentration can be maintained at 3-4. This will avoid increasing of TDS of circulation water for cooling tower.

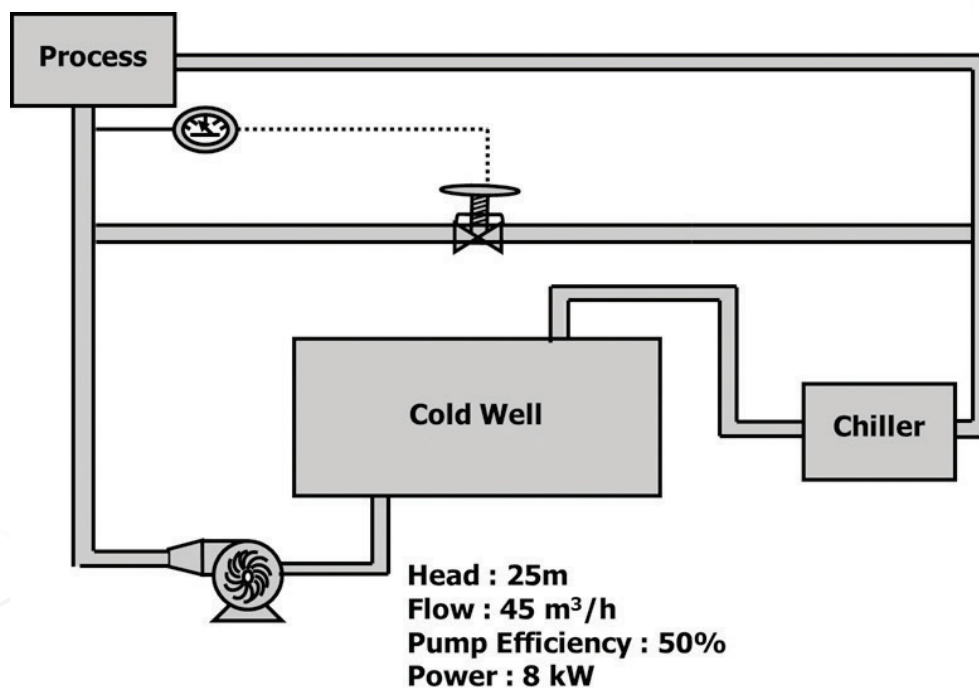

Figure 27: Proposed system for chilled water pumping

The rating of the chilled water pumping system is mentioned above. A recirculation line has to be provided after this modification as the minimum flow through the chiller has to be maintained through the chiller before switching off the chiller compressor. This recirculation line for chiller system will be operated automatically when the users are cut off from the system. Recirculation line will avoid icing of chilled water.

Merits

- ❖ Optimized operation
- ❖ Better efficiency
- ❖ Reliability.

Limitations

- ❖ Requires system modification

Cost Benefit Analysis

The expected savings by modifying pumping system is 23,100 units annually. The annual monetary saving for this project is INR 2.50 lakh, with an investment of **INR 1.50 lakh and a payback period of 08 months.**

Table 49: Cost benefit analysis – Optimize chilled water pumping system

Parameters	UOM	Value
Total Power consumed by primary and secondary pumps	kW	16
Recommended design for new pump		20
Head	m	25
Flow	m ³ /hr	60
Power required for new pump	kW	9.00
Power Savings	kW	7
Days of operation	days per year	300
Hours of operation	hours per day	11
Annual Energy Savings	kWh	23,100
Electricity Cost	INR/kWh	6.3
Savings per year	INR Lakh	1.46
Investment	INR Lakh	4.5
Payback period	months	36.00
IRR	%	48.49
NPV at 70 % Debt (12% rate)	INR lakh	5.31

Energy & GHG Savings



Vendor Details

Table 50: Vendor Details – Optimizing pumping system

Equipment Detail	Energy Efficient Pumps
Supplier Name	Grundfos India
Address	Greenergy Solution Pvt Ltd (Local Dealer) Block 'C', 1st Floor PCM Bus Terminus & Commercial Complex 2nd Mile, Sevoke Road, Siliguri
Contact Person	Mr. SabyaSachi Banerjee
Mail Id	sabyasachi@greenergy.net.in
Phone No	+91 094340-76408

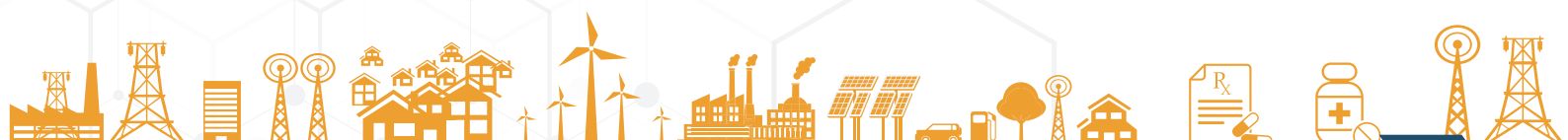

4.3 Case Studies – Utilities

4.3.1 VFD for Air Compressor

Baseline Scenario

The unit under consideration has installed a 15 kW screw compressor to cater to the requirements in the process and instrumentation section. The maximum working pressure of the compressed air in the system is in the range of 6-7 kg/cm². The operating characteristics of the compressor are shown below:

Table 51: Plant compressor loading pattern

Tag No.	Load %	Unload %	Load power, kW	Unload power, kW
Plant air compressor	36	64	17.5	6.6

The loading percentage of the compressor is only 36%, indicating a potential for VFD installation in the compressor. During the time the compressor goes into unload mode, there is no useful work done. Also, since the compressor is of screw type, the losses during unloading are higher in comparison with that of a reciprocating system.

Concept of VFD

Any compressor is designed to go into load & unload conditions. The load and unload pressures for any compressed air system are set such that the average pressure delivered will be the required system pressure. The higher set point of the compressor therefore is a loss.

Also, in the present scenario, the installed compressor is of much higher capacity than compared to the system requirement, which is clear from the 64% unload that the compressor is operating with.

In these two conditions, the most suitable option is to go for a variable frequency drive (VFD). The difference between the normal & VFD condition in a compressor is as shown in the figure here.

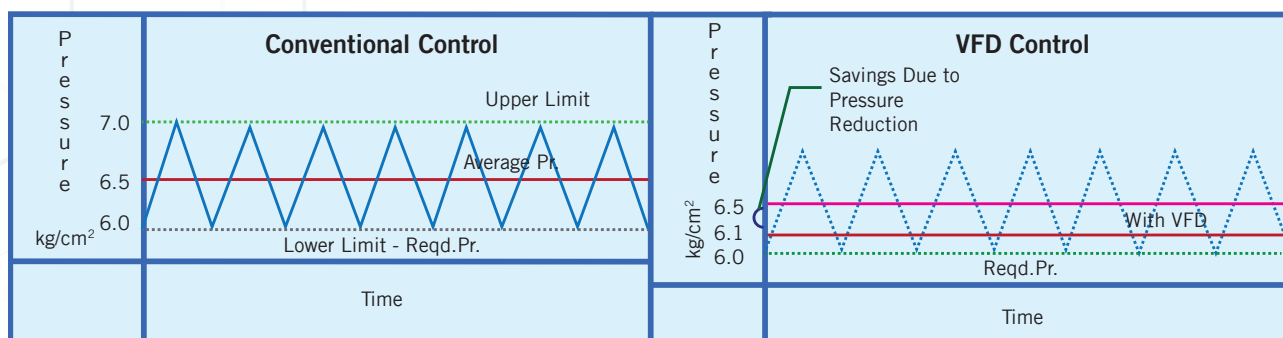

Figure 28: Capacity control of compressor

As seen in the figure, the VFD can be given a set point equal to that which is required in the system. The additional power that the compressor consumes over the required pressure will be the savings achieved.

Proposed System

It is recommended to install VFD and operate that with closed loop for all the above listed compressors to avoid the unloading of the compressors. The feedback for VFD can be given as required receiver pressure. By installing VFD, the compressor can be operated in a pressure bandwidth of ± 0.1 bar. Saving potential of 4.2 kW is available by means of installation of VFD in the Main plant air compressor.

Merits

- ❖ Reduced fluctuations in pressure.
- ❖ Ease of operation.
- ❖ Reliability.

Limitations

- ❖ Viable only up to 40% unload situations.
- ❖ Maintenance issues.
- ❖ Space constraints.

Cost Benefit Analysis

The expected savings by installation of VFD in the compressor is 1,8247 units annually. The annual monetary saving for this project is INR 1.03 lakh, with an investment of **INR 0.90 lakh and a payback period of 11 months.**

Table 52: Cost Benefit Analysis - VFD for Air Compressor

Parameters	UOM	Value
Unloading power of compressor	kW	6.6
Percentage unloading	%	64
Power savings	kW	4.2
Annual operating hours	Hrs	4,320
Annual energy savings	kWh	18,247
Power cost	INR/kWh	5.65
Annual savings	INR lakh	1.03
Investment	INR lakh	0.9
Payback period	months	11
IRR	%	142.02
NPV at 70 % Debt (12% rate)	INR lakh	4.81

Energy & GHG Savings



Vendor Details

Table 53: Vendor Details – VFD for Air Compressor

Equipment Detail	VFD for compressors
Supplier Name	Danfoss Industries Ltd
Address	703,7th Floor, Kaivanya Complex, Near Panchwati Cross Road Ambawadi, Ahmedabad
Contact Person	Mr. Srihari Vyas
Email Id	Shrihari@danfoss.com
Phone No	9825024991

4.3.2 Energy Efficient Pumps

Baseline Scenario

The unit has installed two chilled water pumps for pumping chilled water to process, of which one is running and the other one is on standby. Chilled water required for the various processes is pumped using two pumps of 5.5 kW capacity each. After the process, the return water is coming at 6°C-8°C. The figure below shows the schematic of chilled water system in the plant:

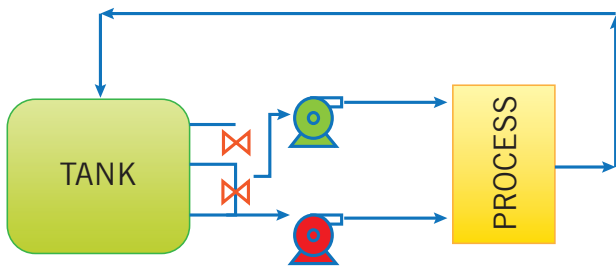

Figure 29: Chilled Water Pumping Systems

The design efficiency of the pump is 39%, which is very low, and the measured efficiency is 31%, which is lower than the design efficiency. The reasons for low efficiency of pump are:

- ❖ Poor operational practices.
- ❖ Pump is very old and undergone frequent maintenance.
- ❖ Poor selection of pump.

Proposed System

It is recommended to replace the old chilled water pump with energy efficient pump. The highly efficient pump will consume less power than low efficiency pumps, which will lead to energy saving. Energy efficient pumps offer higher efficiency than conventional pumps and consume less power, thereby leading to significant energy savings. The new pumps installed have an overall efficiency of 53%. The pump–system curve is illustrated graphically as shown. The point where the system and the pump curve meet is known as the **Best Efficiency Point (BEP)**. The operating efficiency is highest and the radial bearing loads are lowest for a pump at this point. At or near its BEP, a pump operates most cost effectively in terms of both energy efficiency and maintenance. In practical applications, operating a pump

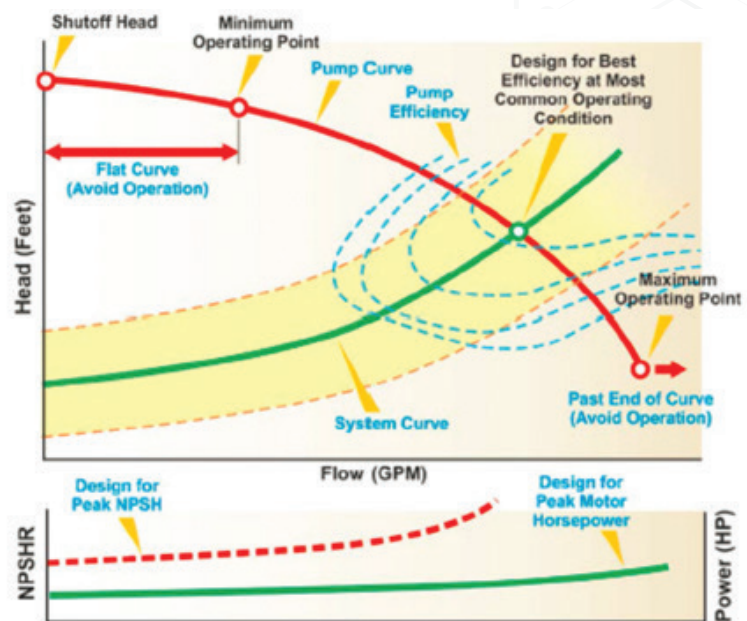

Figure 30: Pump Characteristic Curve

continuously at its BEP is not likely, because pumping systems usually have changing flow rate and system head requirements and demands. Selecting a pump with a BEP that is close to the system's normal operating range can result in significant operating cost savings.

Merits

- ❖ Higher operating efficiencies.
- ❖ Reduced power consumption.
- ❖ Optimum flow & head.

Limitations

- ❖ High installation cost.
- ❖ May require system stoppage during installation.

Cost Benefit Analysis

The expected energy savings to be achieved by installation of new energy efficient pumps is 17,520 units annually. The annual monetary saving for this project is **INR 0.70 lakh, with an investment of INR 0.98 lakh, and a payback period of 17 months.**

Table 54: Cost Benefit Analysis – Energy Efficient Pump

Parameters	UOM	Present	Proposed
Power Consumption	kW	6	4.5
Flow	m ³ /hr	15.5	16
Head	m	40	45
Efficiency	%	35	51
Power Savings	kW		1.5
Electricity Cost	INR/kWh		4
Operating hrs	Hrs/day		8.00
Energy Savings	kWh		17,520
Cost Savings	INR lakh		0.70
Investment	INR lakh		0.98
Payback period	Months		17
IRR	%		66.74
NPV at 70 % Debt (12% rate)	INR lakh		2.34

Energy & GHG Savings



Vendor Details

Table 55: Vendor Details – Energy Efficient Pumps

Equipment Detail	Energy Efficient Pumps
Supplier Name	Grundfos India
Address	Greenery Solution Pvt Ltd (Local Dealer) Block 'C', 1st Floor PCM Bus Terminus & Commercial Complex 2nd Mile, Sevoke Road, Siliguri
Contact Person	Mr. SabyaSachi Banerjee
Email Id	sabyasachi@greenery.net.in
Phone No	+91 094340-76408

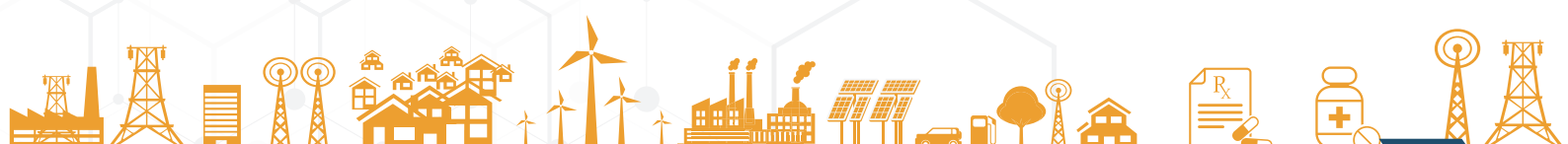

4.3.3 IoT-based Water Management System

Baseline Scenario

Water is an important utility for plants as it governs the hygiene of plants. In the past, abundant and inexpensive sources of water were taken for granted in the processing industry and not much thought was given to economize its use. But, in recent times we have witnessed acute water scarcity and drought conditions in various parts of Karnataka, Tamil Nadu, Andhra Pradesh, Maharashtra, Gujarat, and Rajasthan. With the available water sources becoming scarce, many plants, located in such areas, find it difficult to operate or otherwise expand their operations.

Water is consumed at various points in the facility either as RO water, soft water or raw water. The source of water is either from the nearby borewells or external vendor purchases. The water being used at the central processing unit is water from the RO plant through the pump house. The line which carries water from the RO output splits into two lines; one feeding the central processing unit and the other feeding the ultra-heat treatment plant. Roughly, about 400,000 litres of water is used daily. Certain lacuna observed at the site include the following:

- ❖ Facility's mechanical engineering team had personnel to note down the values – manual errors may have been made while noting down the reading.
- ❖ Location of meters at far off places – Hard to reach, as well as occupational hazards.
- ❖ No real-time data of water being consumed since values were noted down only once a day.
- ❖ Plausible inaccurate and inefficient meter reading led to inaccurate costing of the products.
- ❖ Inaccurate production efficiency calculations.

Proposed System

Water management is an activity of planning, developing, distributing and optimum use of water resources under defined water policies and regulations. Indiscriminate use of water results in excessive wastewater generation, which becomes a burden for the unit in terms of treatment and disposal costs. The IoT system measures the water consumption at various points within the infrastructure and calculates the total water usage and the health of the infrastructure. This consumption pattern is compared with other days, weeks and months' data to ensure a healthy water infrastructure is maintained. The architecture is based on IIoT (Industrial Internet of Things), which is a recent technology. The function monitors the level of the water in OHTs and sumps, ensuring the availability of enough water. Moreover, the user, such as the ground staff or plant manager, can interact with the dashboard using the mobile application or remote desktop application.

Merits

- ❖ Real-time productivity and water consumption monitoring.
- ❖ Helping the executive of the firm keep track of productivity trends and monitor assets.

- ❖ Identifies potential inefficiencies in water consumption.
- ❖ Monitors section-wise consumption of the plant identifies production and cleaning.
- ❖ Tracks and monitors borewell, water pump operations.
- ❖ Monitors every shift-wise consumption to track plant operation effectively.
- ❖ Provide vigilance over the water infrastructure (RO plant, softener, ETP).
- ❖ Excess consumption detection and notifications.
- ❖ Alerts to help make ground staff aware about leakage, wastage and overconsumption.
- ❖ Suitable for outdoor installations.
- ❖ Helps identify the health of RO and softener plants.
- ❖ Quarterly consultant visits by our technical team with water experts along with monthly reports, which helps in water auditing.

Limitations

- ❖ Replacement of mechanical flowmeters in infrastructure with digital meters.

Cost Benefit Analysis

The annual monetary saving for this project is **INR 1.70 lakh, with an investment of INR 1.12 lakh, and a payback period of 08 months.**

Table 56: Cost Benefit Analysis – IOT Based Water Management System

Parameters	UOM	
Measurement point Cost	INR	1,10,000
Total water Consumption daily	kl	12,000
Per kl	INR/kl	69
Average monthly increment tariff per kl	INR	0.5
Number of consumption points	Nos	17
Number of level measurement points	Nos	4
Minimum Consumption error Expected at one point	%	1
Energy and Maintenance Savings	INR	10,000
Monetary Savings	INR lakh	1.70
Investment	INR lakh	1.12
Payback period	months	8
IRR	%	181.12
NPV at 70% Debt (12% rate)	INR lakh	8.10

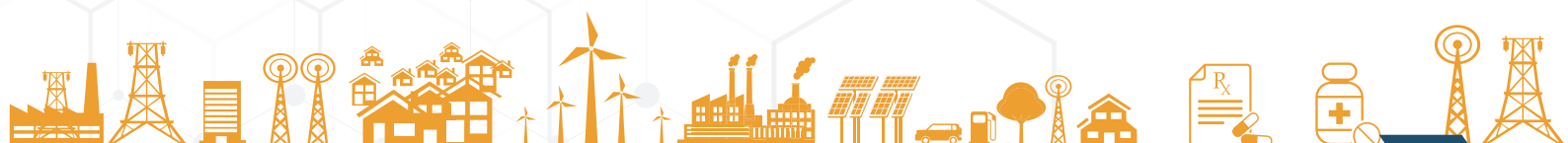

Reference Plant Implementation

Table 57: Reference Plant Implementation – IOT based water management system

Project Name	IoT based water management system
Objective	To conserve water in dairy industry – IoT-based water management tool
Unit profile	Winner processing unit was established on 25 January 1993 at Pondicherry. It is involved in the manufacture of dairy product and production of raw milk. Winner Dairy's daily production unit outlet processes nearly 2,50,000 litres of milk every day, and produces milk-based by-products as well.
Installation Photo	
Assumptions Made	<ul style="list-style-type: none"> ❖ Total water consumption at the facility. ❖ Cost incurred in water infrastructure. ❖ Expenditure in electricity due to water infrastructure. ❖ Operating hours of the plant.
Savings (INR lakh)	₹ 1.70
Investment (INR lakh)	₹ 1.10
Simple Payback Period	8 months
Replication potential	In all the pharma units.
Outcomes	<ul style="list-style-type: none"> ❖ Excess consumption detection, alerts and notifications leading to a reduction in water usage translating to monetary savings. ❖ Real-time productivity and water consumption monitoring. ❖ Help the executive of the firm to keep track of productivity trends and monitor assists.
Unit contact details	Mr. Ayyanar Winner Dairy Email: er.sp.senthil@gmail.com Phone: +91 8883054141
Cluster Reference	Tamil Nadu, Pondicherry

Vendor Details

Table 58: Vendor Details – IOT Based Water Management System

Equipment Detail	IoT-based water management system
Supplier Name	FluxGen Engineering Technologies
Address	1064, 1st floor, BTM layout 2nd Stage, Bangalore
Contact Person	Mr. Ganesh Shankar
Mail Id	ganesh@fluxgentech.com
Phone No	+91 9731925888



4.3.4 Replacement of plant HP compressor with LP compressor

Baseline Scenario

Plant is operating with HP compressor for pushing the material from reactor. The set point pressure is 2.5 – 6.5 bar and the plant user end requirement pressure are maximum 2 bar only and Power consumption 7 kW.

Capacity test conducted on the compressor and the specific energy consumption is 0.30 kW/CFM, which is on a very higher side for HP compressors.

Table 59: Performance of HP compressor

Parameters	UOM	Operating
FAD	CFM	23
Pressure	kg/cm ²	2.5-6.5
Power	kW	7
SEC	kW/CFM	0.30

If efficiency of the compressor reduces, it will increase the specific power consumption of the compressor, and the general reasons for low efficiency are ageing of compressor, proper maintenance requirement, or the design itself.

Proposed System

It is recommended to replace the HP compressor with a highly efficient LP compressor with 2 kg/cm² pressure and operating at an SEC of 0.10 kW/CFM.

Merits

- ❖ Higher operating efficiencies.
- ❖ Reduced power consumption.

Limitations

- ❖ High installation cost.
- ❖ May require system stoppage during installation.

Cost Benefit Analysis

The expected energy savings to be achieved by installation of new energy efficient LP compressor is 5,397 units annually. The annual monetary saving for this project is **INR 0.34 lakh, with an investment of INR 1.00 lakh, and a payback period of 35 months.**

Table 6o: Cost Benefit Analysis – Energy Efficient LP Compressor

Parameters	UOM	
Load power of compressor	kW	7
FAD of compressor	CFM	23
SEC of compressor	kW/CFM	0.30
SEC of new LP compressor	kW/CFM	0.10
Power Savings	kW	2.57
Annual Hours of operation	Hrs	2100
Annual Energy Savings	kWh	5,397
Electricity Cost	INR/kWh	6.3
Savings per year	INR Lakh	0.34
Investment	INR Lakh	1.00
Payback period	months	35
IRR	%	50.70
NPV at 70 % Debt (12% rate)	INR lakh	1.27

Energy & GHG Savings

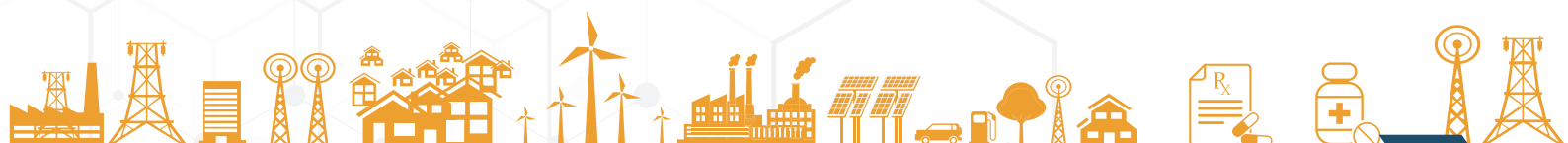

Vendor Details

Table 61: Vendor Details – LP Compressor

Equipment Detail	Compressor
Supplier Name	Atlas Copco
Address	Greenergy Solution Pvt Ltd (Local Dealer) Block 'C', 1st Floor PCM Bus Terminus & Commercial Complex 2nd Mile, Sevoke Road, Siliguri
Contact Person	Mr. SabyaSachi Banerjee
Mail Id	sabyasachi@greenergy.net.in
Phone No	+91 094340-76408

4.4 Case Studies – Renewable Energy

4.4.1 Solar rooftop system

Baseline Scenario

The unit is purchasing electricity from grid for the power requirement in its plant. The contract demand of the plant is 260 kVA, with electricity priced at INR 7.0/kWh, with an average load of 150 kW to 200 kW. The unit has enough rooftop area which can be utilized to install solar PV for self-generation of electricity rather than purchasing from grid. The site specifications for rooftop PV are given below:

Table 62: Site Specification – For Solar PV

Parameters	
Effective Rooftop available	200 sq. m. true south
Location	Latitude: -27.15° N, Longitude: - 88.15° E
Altitude above sea level, m	1,315 m
Direct Normal Irradiance	4.22 kWh/m ² /day
Wind	2.77 m/sec
Humidity	24%

The following graphs highlights solar irradiance:

Latitude : 27.15 Longitude : 88.15

Annual Average : 4.22 kWh/m²/day

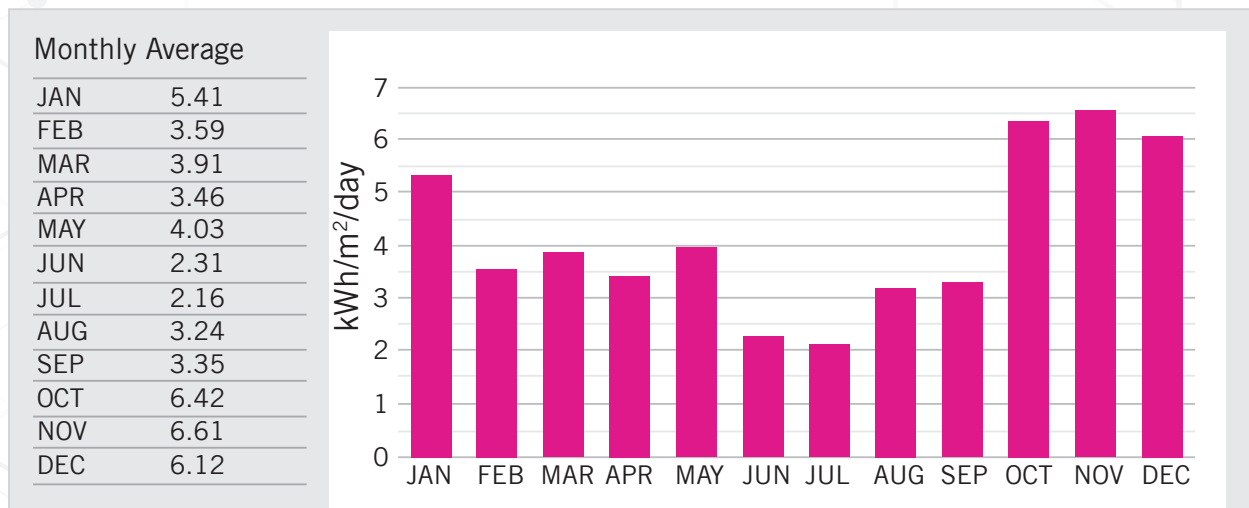

Figure 31: Solar Irradiance

Proposed System

As per the site specifications, the unit has a potential of installing 25 kWp solar rooftop which can generate around 0.40 lakh units of electricity annually. The proposed system will be a grid-tied Solar PV power plant consisting PV array, Module Mounting Structure, Power Conditioning Unit (PCU) consisting of Maximum Power Point Tracker (MPPT), Inverter, and Controls & Protections, interconnect cables, junction boxes, distribution boxes and switches. PV Array is mounted on a suitable structure. Grid-tied PV system is without battery and should be designed with necessary features to supplement the grid power during daytime. In grid-connected rooftop or small PV system, the DC power generated from PV panel is converted to AC power using power converter, and is fed to the grid either of 33 kV/11 kV three phase lines or of 440V/220V three/single phase line, depending on the local technical and legal requirements. These systems generate power during the daytime, which is utilized by powering captive loads and feeding excess power to the grid. In case the power generated is not sufficient, the captive loads are served by drawing power from the grid.

Net Metering Business Model - The net metering-based rooftop solar projects facilitate the self-consumption of electricity generated by the rooftop project and allows for feeding the surplus into the grid network of the distribution by the licensee. The type of ownership structure for installation of such net metering-based rooftop solar systems becomes an important parameter for defining the different rooftop solar models. In a grid-connected rooftop photovoltaic power station, the generated electricity can sometimes be sold to the servicing electric utility for use elsewhere in the grid. This arrangement provides payback period on the investment of the installer. Many consumers from across the world are switching to this mechanism owing to the revenue yield. A commission usually sets the rate that the utility pays for this electricity, which could be at the retail rate or the lower wholesale rate, greatly affecting solar power payback period and installation demand. The features/ requirements for grid-connected rooftop Solar PV system are as follows:

Table 63: Features/requirements for Grid Connected Solar PV Systems (Rooftop)

S. No.	Features / Requirements	Values
1	Shadow free roof area required	10 m ² /kWp or 100 ft ² /kWp.
2	Roof suitable for Solar PV system	Concrete/ GI/ tin shed (Asbestos may not be suitable)
3	Orientation of the roof	❖ South facing roof is most suitable. ❖ Installation may not be feasible beyond 5 deg slope.
4	Module installation	❖ Modules are installed facing South. ❖ Inclination of modules should be equal closer to the latitude of the location for maximum energy generation.

S. No.	Features / Requirements	Values
5	Cost of the rooftop solar PV system	<p>MNRE issues benchmark cost for GCRT PV system and the cost for general category states for 2019-20 are as follows. This includes cost of the equipment, installation and O&M services for a period of 5 years.</p> <ul style="list-style-type: none"> ❖ Above 1 kWp and up to 10 kWp: INR 54,000/ kWp ❖ Above 10 kWp and up to 100 kWp: INR 48,000/ kWp ❖ Above 100 kWp and up to 500 kWp: /INR 45,000/ kWp <p>Based on discussions with a few project developers, average cost of the system (as per market conditions) is as follows:</p> <ul style="list-style-type: none"> ❖ For 10 kWp system, INR 49,000/ kWp ❖ For 50 kWp system, INR 42,500/ kWp ❖ For 100 kWp system, INR 37,000/ kWp
6	Useful life of the system	25 years

Merits

- ❖ PV panels provide clean & green energy. During electricity generation with PV panels, there is no harmful greenhouse gas emissions.
- ❖ Technology development in solar power industry is constantly advancing, which can result in lower installation costs in the future.
- ❖ PV panels have no mechanically moving parts, except in cases of sun-tracking mechanical bases; consequently, they have far less breakages or require less maintenance than other renewable energy systems (e.g. wind turbines).

Limitations

- ❖ The initial cost of purchasing a solar PV system is high, which includes paying for solar panels, inverter, batteries, and wiring and for the installation.
- ❖ Although solar energy can be still collected during cloudy and rainy days, the efficiency of the system drops, which results in lower generation of energy.
- ❖ Installing a large PV system takes up a lot of space.

Cost Benefit Analysis

The expected savings by installation of 25 kWp solar rooftop is 40,000 units of electricity annually. The annual monetary saving for this project is **INR 2.60 lakh, with an investment of INR 12.50 lakh, and a payback period of 57 months.**

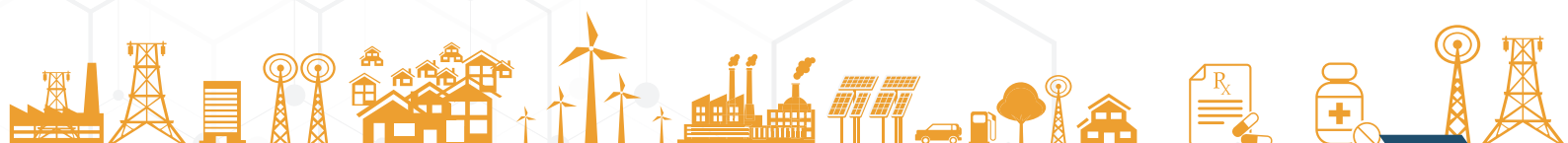

Table 64: Cost Benefit Analysis – Solar PV Systems

Parameters	UOM	
Proposed Roof top Solar installation	kW	25
Annual units generation per kW of Solar PV	kWh per kW/year	1,600
Total Energy Generation Per Annum	kWh/year	40,000
Electricity Cost	INR/kWh	7
Cost Savings	INR lakh	2.60
Investment	INR lakh	12.50
Payback period	years	57
IRR	%	19.81
NPV at 70 % Debt (12% rate)	INR lakh	4.45

Energy & GHG Savings



Vendor Details

Table 65: Vendor Details – Solar PV

Equipment Detail	Solar PV System
Supplier Name	Varizone Solar Pvt. Ltd.
Address	Shop no. 2/3, Amrut Nagar, Hari Nagar-2, Opp. Swaminaryan Temple, Udhna, Surat
Contact Person	Mr. Parshwa Shah
Email Id	varizonesolar@gmail.com
Phone No	+91 9426111113

4.4.2 Solar-Wind Hybrid system

Baseline Scenario

The unit is purchasing electricity from grid for the electrical energy requirement. The contract demand of the plant is 450 kVA, with an electricity price of INR 6.5/kWh, and average operating load is 260 kW to 300 kW.

Renewable energy is deemed to be the best substitute for conventional fossil fuel. Implementation of renewable energy posts various challenges, such as capital cost and consistency of power output, of which the latter can be solved by the installation of a Solar – Wind hybrid system. The plant has enough rooftop area which can be utilized to install a solar-wind hybrid system that can harness solar energy and wind energy to generate electricity.

Proposed System

The Solar – Wind Hybrid system is also known as solar mill. The solar mill generates:

- ❖ Daytime energy from the sun and wind.
- ❖ Day & night energy from the wind energy.
- ❖ Energy even on cloudy days.
- ❖ More energy on hot sunny days due to cooling effect on solar panels by wind.



Figure 32: Solar wind hybrid system

It consists of three vertical axis wind turbines coupled to three permanent magnet generators. Automatic mechanical braking is provided once the wind speed goes beyond the cut-off speed. On board smart electronics include dynamic Maximum Power Point Tracking (MPPT). It uses wind and solar resources on a 24/7/365 basis, allowing access to energy and very little interruption of services. The design life of solar mill is 25 years.

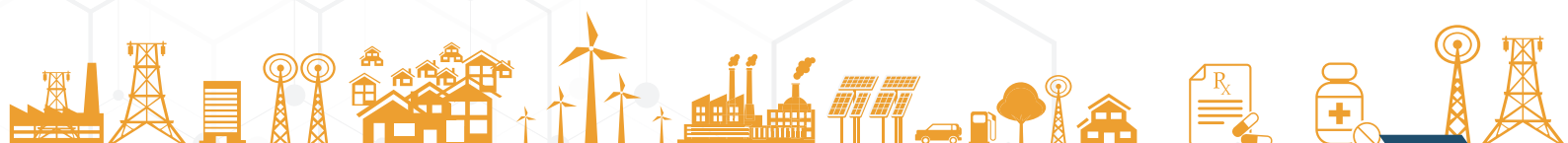

Specifications

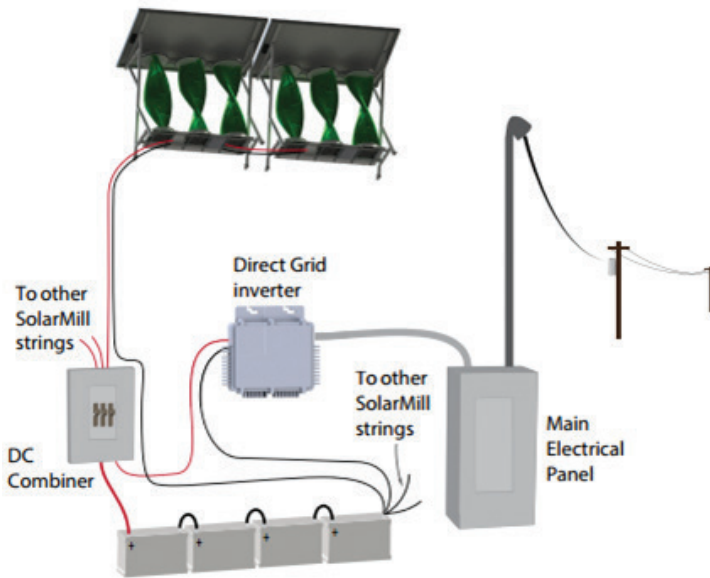

Figure 33: Hybrid mill connected to supply

The increase of renewable power per square foot of roof is obtained by combining two power sources. For a rooftop installation, combining solar and wind power is a complementary combination. For example, many locations are less windy in the middle of the day when the sun is at its peak, and the wind picks up after dusk. Other advantages are solar module providing protection for the wind portions of the mechanism from direct rain and hail, and assisting with the direction of air into the turbines.

Since this compact installation is designed for rooftops and urban atmosphere, savonius type of wind turbine is chosen for its low running speed and relative insensitivity to turbulence. Power generation begins at a wind speed of 5 kmph. Independent MPPT for both wind and solar is calibrated. Maximum power point tracking (MPPT) is an algorithm included in charge controllers used for extracting maximum available power. The power from both wind and solar generation is routed into a common 48V DC bus which has built-in charge control for a lead acid battery bank.

Modes of Use

In grid tied system, the bank of batteries is connected to one or more Direct Grid micro-inverters, which connect to the user's electrical panel. The inverters push power back to the grid efficiently when the batteries become fully charged.

In off grid storage, the batteries can be used to supply power to electrical devices in off grid settings. This electrical energy can power DC powered devices through a voltage converter, or can power AC devices through an inverter.

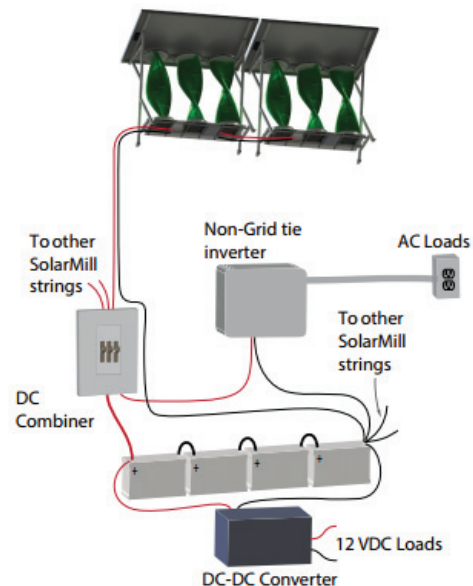

Figure 34: Hybrid mill connected to loads

Merits

- ❖ Power generation during daytime as well as nighttime.
- ❖ Reliable power generation even on cloudy days.
- ❖ A compact hybrid solar mill to meet a portion of the plant's load after detailed study with vendors.
- ❖ Power generation starts at 2-5 m/s and mechanical braking occur beyond 18 m/s.
- ❖ The power generation can be monitored online.

Limitations

- ❖ Higher investment.

Cost Benefit Analysis

The expected savings in electrical energy to be achieved by installation of a 50 kWp Solar – Wind hybrid system is 1,32,000 units annually. The annual monetary saving for this project is **INR 8.60 Lakh, with an investment of INR 45.00 lakh, and a payback period of 63 months.**

Table 66: Cost Benefit Analysis – Solar Wind Hybrid Systems

Parameters	UOM	
Installed Capacity of Solar wind Mill	kWp	50
Average generation per day per kWp	kWh	6.0
Area Required	m ²	60
Annual operating days	Days	365
Electricity Tariff	INR/kWh	6.5
Average Annual Energy Saving on conservative basis	kWh	1,09,500
Annual cost savings	INR lakh	7.11
Investment	INR lakh	50
Payback Period	Months	63
NPV at 70% Debt (12% rate)	INR lakh	13.15
IRR (%)	%	20.88

Energy & GHG Savings



Vendor Details

Table 67: Vendor Details – Solar-Wind Hybrid Systems

Equipment Detail	Solar - wind hybrid system
Supplier Name	Windstream Technologies
Address	G2-SSH Pride, Plot 273, Road No-78, Jubilee Hills, Hyderabad 500096
Contact Person	Mr. Bhaskar Sriram
Email Id	bhaskars@windstream-inc.com
Phone No	+91 99599 18782

5. Conclusion

In a typical pharma unit, heating and cooling operations are dominant energy users. Due to the wide variation in product mix among the units, overall energy and specific energy consumption indicators vary significantly from plant to plant, making it extremely difficult to compare for performance or for identifying efficiency improvement opportunities. Other reasons for such wide variation also include level of technology adopted, vintage of these facilities, capacity utilization and fuel mix used in their operations. Significant energy efficiency improvement opportunities in units exist in heating and cooling applications via adoption of co-generation technology, de-superheaters, evaporative cooling systems, utilization of renewable energy; biomass-fired boilers and increased automation. Through this compendium, some of the key technologies that are highly replicable in the cluster have been identified, and for these technologies the case examples are included.

The identified technologies can be categorized into three heads, namely, Level 1, Level 2, and Level 3, based on the investment requirement and the payback period, as follows:

❖ **Level 1:** Low investment

- ❖ VFD for chilled water pumps.
- ❖ Optimized chilled water pumping system
- ❖ Replace three port valves with two-part valves for AHUs and install VFD for chilled water pump.
- ❖ VFD for Air Compressor.
- ❖ Energy Efficient Pumps.
- ❖ IoT-based Water Management System.
- ❖ VFD in Screw Chiller Compressor.
- ❖ Replacement of HP air compressor with LP compressor
- ❖ Electronically Commutated motors for AHUs.
- ❖ kVAR Energy Compensator for Chiller Compressor.

❖ **Level 2:** Medium investment

- ❖ Online Condenser Cleaning System.
- ❖ Steam Operated Pumping Traps.
- ❖ Condensate Recovery System.
- ❖ Active refrigerant agent addition in lube oil for chillers.
- ❖ Waste Heat Recovery from chiller compressor



❖ **Level 3: High investment**

- ❖ Steam Driven Heat Pump
- ❖ Solar rooftop system.
- ❖ Conversion of furnace HSD-fired boiler to intelligent biomass-fired boiler.
- ❖ Evaporative Condenser.
- ❖ Solar–Wind hybrid system.

Sr. No.	Technologies	Ease of Implementation			Priority of activity (based on payback)		
		Easy	Moderate	Difficult	Short	Medium	Long
Steam Generation and Distribution							
1	Conversion of Furnace HSD Fired Boiler to Fully Automated Biomass Fired Boiler			√			√
2	Condensate Recovery System		√		√		
3	Steam Operated Pumping Traps	√				√	
4	Steam Driven Heat Pump			√	√		
Refrigeration Systems							
5	VFD for Screw Chiller	√				√	
6	Waste Heat Recovery from Chiller Compressors	√				√	
7	kVAr Energy Compensator for Chiller Compressor	√				√	
8	VFD for chilled water pumps	√			√		
9	Evaporative Condenser		√			√	
10	Electronically Commutated motors for AHUs	√			√		
11	Online Condenser Cleaning System		√				√
12	Replace three port valves with two-part valves for AHUs and install VFD for chilled water pump	√			√		
13	Active refrigerant agent addition in lube oil for chillers	√				√	
14	Optimize chilled water pumping system	√				√	

Sr. No.	Technologies	Ease of Implementation			Priority of activity (based on payback)		
		Easy	Moderate	Difficult	Short	Medium	Long
Utilities							
15	VFD for Air Compressor	√			√		
16	Energy Efficient Pumps	√				√	
17	IoT-based Water Management System		√		√		
18	Replacement of plant HP compressor with LP compressor	√				√	
Renewable Energy							
19	Solar Rooftop system	√					√
20	Solar-Wind Hybrid system	√					√

The energy efficiency/renewable energy projects detailed in the case studies in this compendium indicate that there is a good potential for benefits in both low hanging and medium-to-high investment options. The units can implement the low hanging fruits (with smaller investments) faster, as with minimum or no investments, several savings can be achieved. However, for the high investment projects, a detailed review in the form of DPR can be prepared. The attractiveness of the project can also be assessed from the unit abatement cost (UAC). The UAC is defined as the cost/investment of reducing one unit of energy or pollution. The options having lower UAC are attractive to reduce a unit of energy consumption as lower investments are required to achieve energy savings. The following graph highlights the comparison of Unit Abatement Cost as Investment (INR Lakh)/Energy Saving achieved (TOE), for the major proposals identified at the Sikkim Pharma cluster:

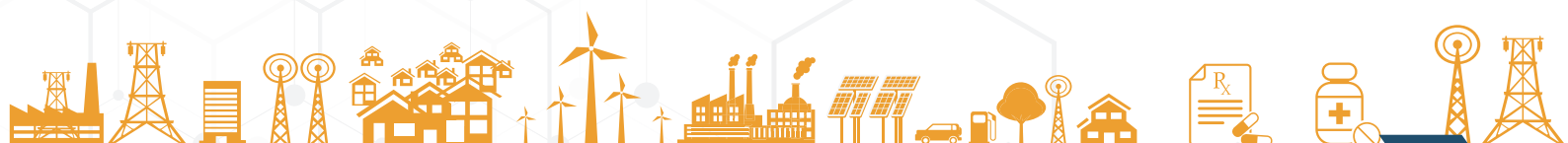

UAC: INVESTMENT (INR LAKH)/ENERGY SAVINGS (TOE)

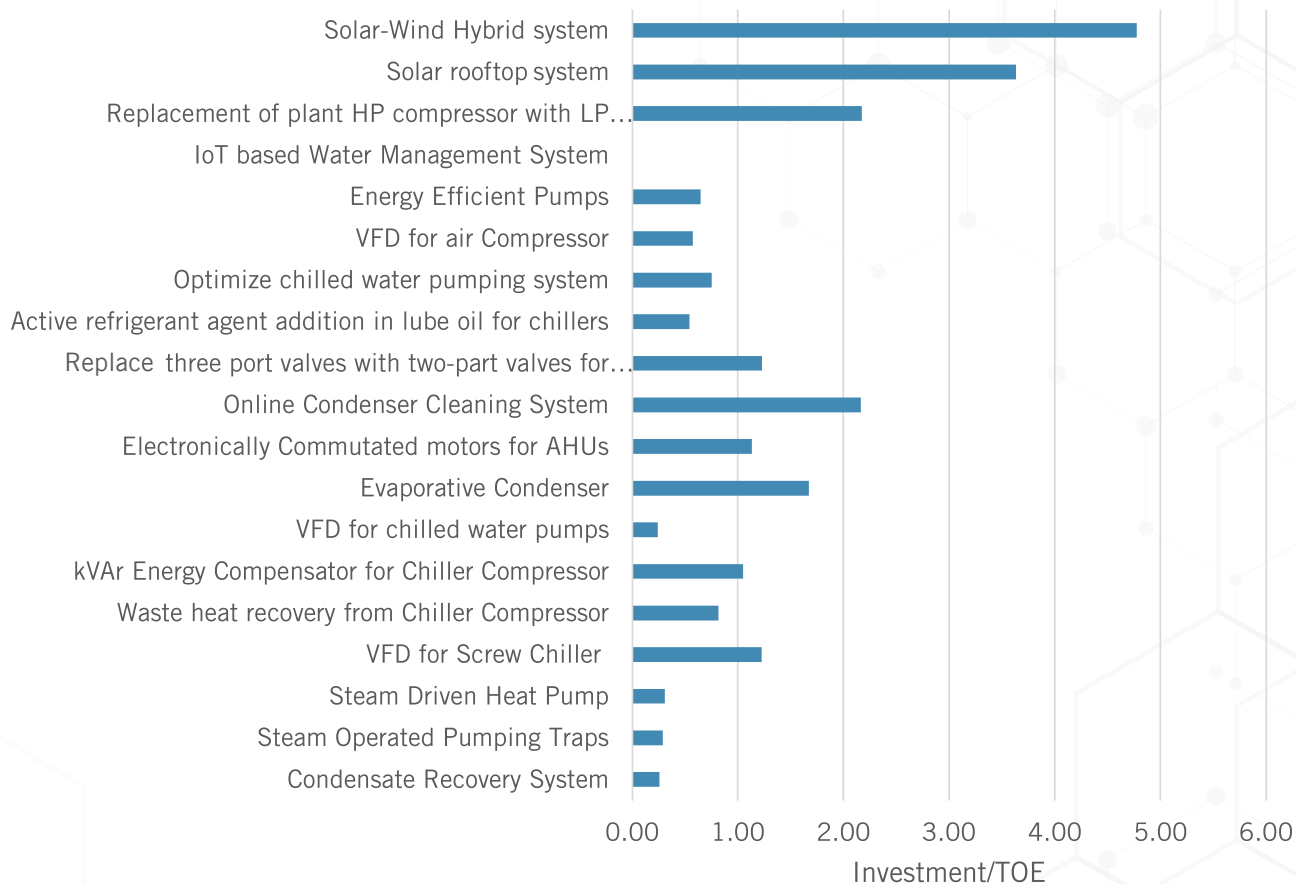
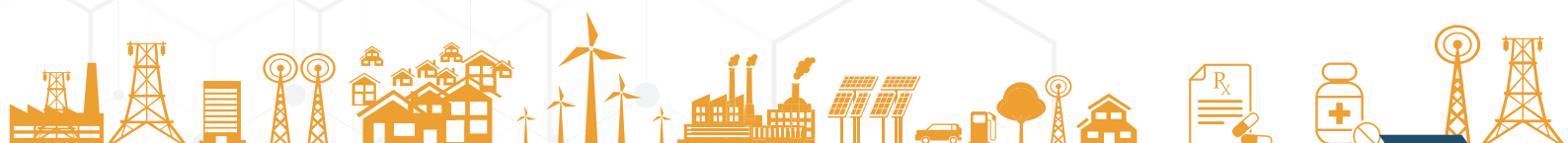

Figure 35: Unit Abatement Cost - Energy Efficient Technologies

The Sikkim pharma cluster should view this manual positively and utilize this opportunity to implement the best operating practices and energy saving ideas during design and operation stages, and thus move towards achieving world class energy efficiency.

Bibliography

1. IBEF Presentation on Sikkim Land of Peace and Tranquility
2. The Pharmaceutical Industry & Global Health, Facts & Figures 2017 (International Federation of Pharmaceutical Manufacturers & Associations)
3. KPMG – The US India dynamic prospering together; June 2018
4. <https://www.ibef.org/industry/pharmaceutical-india.aspx>



For more details, please contact



**UNITED NATIONS
INDUSTRIAL DEVELOPMENT ORGANIZATION**

Vienna International Centre
P.O. Box 300 · 1400
Vienna · Austria
Tel.: (+43-1) 26026-0
ENE@unido.org
www.unido.org

UNIDO
Regional office in India
UN House
55 - Lodi Estate,
New Delhi-110 003, India
office.india@unido.org



Bureau of Energy Efficiency

Government of India, Ministry of Power

4th Floor, Sewa Bhawan,
R. K. Puram,
New Delhi - 110 066
India
Tel.: (+91) 011 2617 9699-0
gubpmu@beenet.in
www.beeindia.gov.in