



UNITED NATIONS
INDUSTRIAL DEVELOPMENT ORGANIZATION



Technology Compendium for Energy Efficiency and Renewable Energy Opportunities in Dairy Sector

Madhya Pradesh Dairy Cluster



UNITED NATIONS INDUSTRIAL DEVELOPMENT ORGANIZATION

September 2020



Disclaimer

This document is prepared to provide overall guidance for conserving energy and costs. It is an output of a research exercise undertaken by Confederation of Indian Industry (CII) supported by the United Nations Industrial Development Organization (UNIDO) and Bureau of Energy Efficiency (BEE) for the benefit of the ***Dairy Industry located at Madhya Pradesh, India***. The contents and views expressed in this document are those of the contributors and do not necessarily reflect the views of CII, BEE or UNIDO, its Secretariat, its Offices in India and elsewhere, or any of its Member States.

Promoting Energy Efficiency and Renewable Energy in Selected MSME Clusters in India

(A GEF funded project being jointly implemented by UNIDO & BEE)



UNITED NATIONS
INDUSTRIAL DEVELOPMENT ORGANIZATION



Compendium of

Energy Efficiency and Renewable Energy Technologies for Madhya Pradesh Dairy Cluster

September 2020

Developed under the assignment

Scaling up and expanding of project activities in MSME Clusters

Prepared by



Confederation of Indian Industry
125 Years - Since 1895

CII Sohrabji Godrej Green Business Centre
Survey No.64, Kothaguda Post, R R District,
Hyderabad, Telangana 500084
INDIA



Acknowledgement

Acknowledgement

This assignment was undertaken by Confederation of Indian Industry (CII) as a project management consultant under the Global Environment Facility (GEF) funded project ‘Promoting Energy Efficiency and Renewable Energy in selected MSME clusters in India.’ The Technology Compendiums are meant to serve as an informative guide to the clusters that the project is currently working in and also to the other potential clusters across the country.

CII would like to express its gratitude to United Nations Industrial Development Organization (UNIDO) and Bureau of Energy Efficiency (BEE) for having provided the guidance in the completion of this assignment.

CII would like to specially thank all the professionals for their valuable contributions in finalizing the different technology compendiums developed under the assignment. CII is grateful to Mr. Abhay Bakre, Director General, BEE, Mr R K Rai, Secretary, BEE and Mr. Milind Deore, Director, BEE for their support and guidance during the assignment. CII would like to express its appreciation to Mr. Sanjaya Shrestha, Industrial Development Officer, Energy Systems and Infrastructure Division, UNIDO, for his support in execution of the assignment. We would like to thank Mr. Suresh Kennit, National Project Manager, and the entire Project Management Unit (PMU) for their timely coordination and valuable inputs during the assignment.

CII would like to take this opportunity to thank all the dairies, local service providers and equipment suppliers for their active involvement and valuable inputs in the development of the technology compendiums. We extend our appreciation to the different Industry Associations in the clusters for their continuous support and motivation throughout the assignment.

Finally, we would like to thank each and every personnel from CII team who have been actively involved at every step of the compilation and whose tireless and valuable efforts made this publication possible.

CII Team

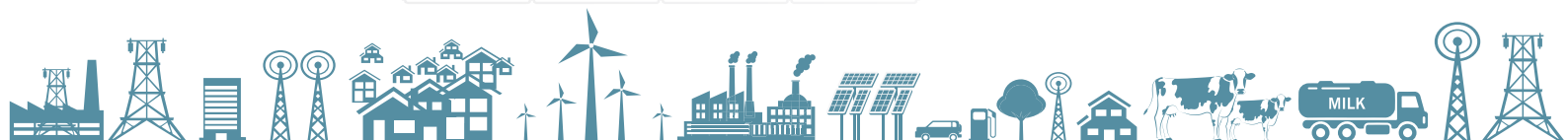
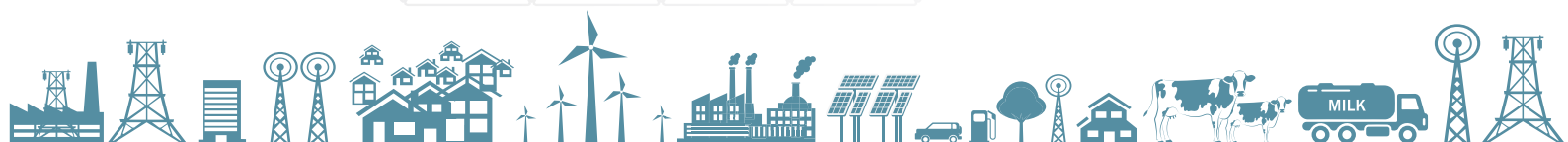
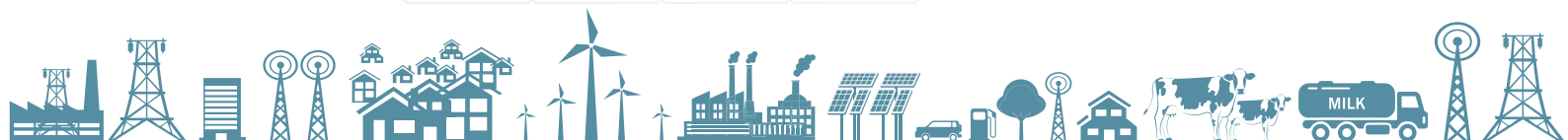
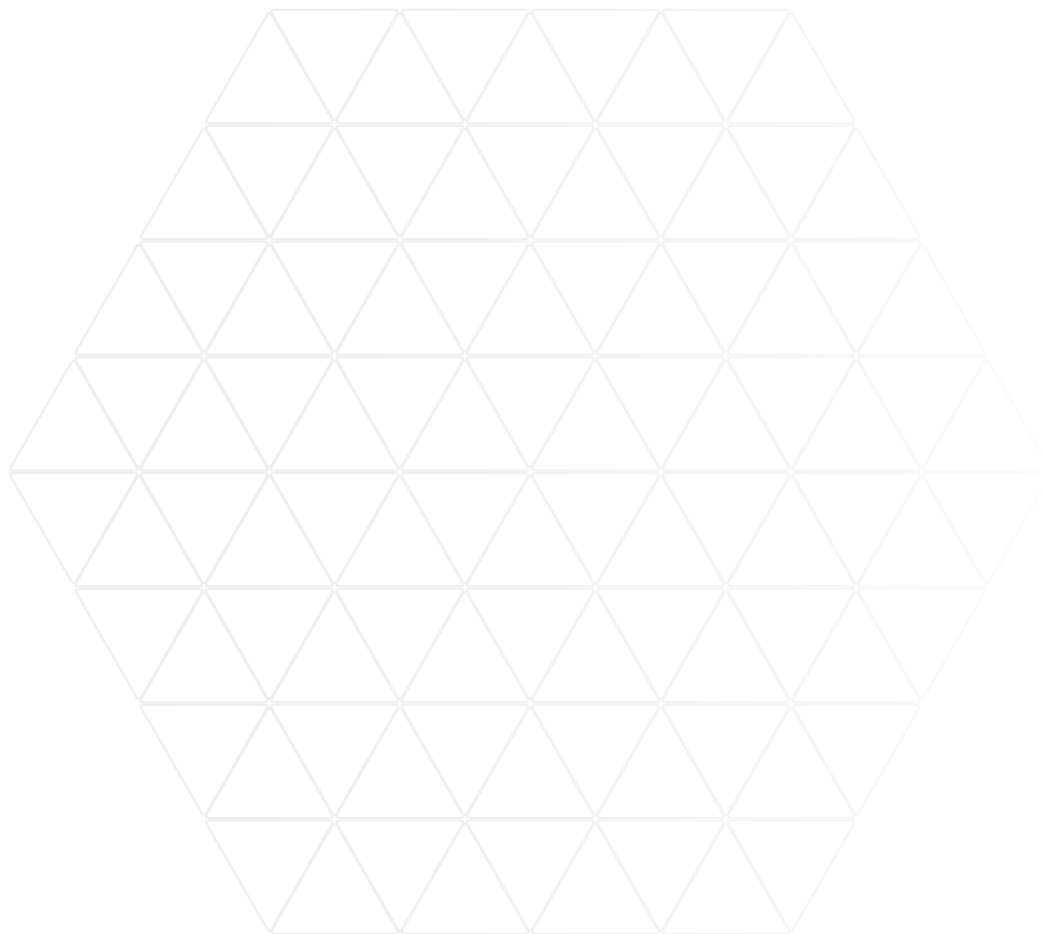

Table of Contents

List of Figures	8
List of Tables	10
List of Abbreviations.....	13
Unit of Measurements	16
About the Project	19
About the Technology Compendium	21
Executive Summary	23
1. Indian Dairy Industry	27
1.1 Background	27
1.2 Dairy Sector Growth Prospects	28
1.3 Madhya Pradesh Dairy Cluster	29
2. Dairy Process	33
2.1 Dairy Sector Overview.....	33
2.2 Overview: Process Flow in Dairy Plant	34
2.3 Energy Consumption in Dairy Plants.....	38
2.4 Technology Status in Madhya Pradesh Dairy Cluster	40
3. Energy Efficiency Opportunities	43
3.1 Energy Efficiency in Dairy	43
3.2 Energy Efficiency Measures	44
3.2.1 Energy Efficiency in Steam Systems	45
3.2.2 Energy Efficiency in Refrigeration Systems.....	46
3.2.3 Energy Efficiency in Process	47
3.2.4 Energy Efficiency in Utilities	48
3.2.5 Best Practices and Key Indicators for Energy Efficiency.....	50
4. Energy Efficient Technologies – Case Studies	55
4.1 Case Studies in Steam Generation and Distribution	57
4.1.1 Conversion of Furnace Oil Fired Boiler to Biomass Fired Boiler.....	57
4.1.2 Condensate Recovery System	63
4.1.3 Steam Operated Pumping Traps.....	68
4.2 Case Studies in Refrigeration Systems	72
4.2.1 Installation of screw refrigeration compressor.....	72
4.2.2 VFD in Reciprocating Chiller Compressor	77
4.2.3 Replacement of low speed reciprocating compressor with high speed reciprocating chiller	82
4.2.4 Energy efficient submersible agitators for IBT	86
4.2.5 Falling Film Chiller (FFC)	89
4.2.6 Direct Cooling Method – IBT.....	94
4.2.7 Double effect steam driven vapour absorption chiller heater	98
4.2.8 Desuperheater for Chiller Compressors	104
4.2.9 kVAR Energy Compensator for Chiller Compressor	109



4.2.10 VFD for chilled water pumps	113
4.3 Case Studies – Bulk Milk Cooler.....	117
4.3.1 Thermal Energy Storage for BMC	117
4.3.2 BMC Remote Monitoring System	123
4.4 Case Studies – Utilities	128
4.4.1 VFD for air Compressor.....	128
4.4.2 Energy Efficient Pumps	131
4.4.3 Package Type Biogas Reactor	135
4.4.4 Methane Capture from dairy effluents	139
4.4.5 IoT based Water Management System	145
4.5 Case Studies – Process Area.....	149
4.5.1 Installation of High Regenerating Efficiency Pasteurizer.....	149
4.5.2 Preheating of incoming milk in curd Pasteurizer.....	153
4.6 Case Studies - Renewable Energy	156
4.6.1 Solar rooftop system.....	156
4.6.2 Solar Thermal System	161
4.6.3 Solar-Wind Hybrid system.....	167
5. Conclusion	171
Bibliography	175



List of Figures

Figure 1: Milk Production and Per Capita Availability in Country (NDDB, 2019).....	27
Figure 2: Milk Production – state wise	27
Figure 3: Annual milk production over the last few years	29
Figure 4: Dairy Institutional Structure – Madhya Pradesh	30
Figure 5: Geographical locations of MPCDF plants.....	31
Figure 6: Milk Processing Value Chain	33
Figure 7: Milk Processing Flow.....	34
Figure 8: Milk Receiving	34
Figure 9: Pasteurization process	35
Figure 10: Milk Standardization Process	35
Figure 11: Homogenization Process	36
Figure 12: Auto CIP – (Source Alfa Laval).....	36
Figure 13: Milk Packaging.....	37
Figure 14: Energy Cost – Breakup (Dairy Plant)	38
Figure 15: Energy Balance of a Dairy Plant.....	38
Figure 16: Energy Efficiency Approach – Dairy Industry.....	43
Figure 17: Dairy - Energy Consumption Overview	44
Figure 18: Typical condensate recovery system	63
Figure 19: Heat content in condensate.....	64
Figure 20: Steam Loss Chart.....	69
Figure 21: IBT temperature profile.....	78
Figure 22: Compressor Suction Pressure.....	78
Figure 23: Submersible agitators.....	86
Figure 24: Falling film chiller	90
Figure 25: Typical operating efficiency analysis for different seasons	94
Figure 26: Post Implementation – Direct Cooling Method	95
Figure 27: Comparison over conventional system.....	98
Figure 28: VAM working	99
Figure 29: Vapour Compression Cycle	104
Figure 30: WHR from chiller compressor	105
Figure 31: kVAr energy compensator.....	109
Figure 32: Existing pumping layout.....	113
Figure 33: Dairy Value Chain.....	117
Figure 34: Schematic layout for Instant Milk Cooler	119
Figure 35: Cooling time with and without instant milk chiller	119
Figure 36: MBRT before installation of remote monitoring system.....	124
Figure 37: Dashboard list of BMC.....	124

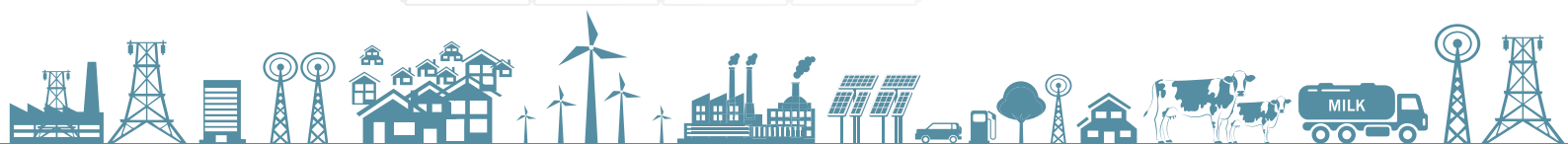
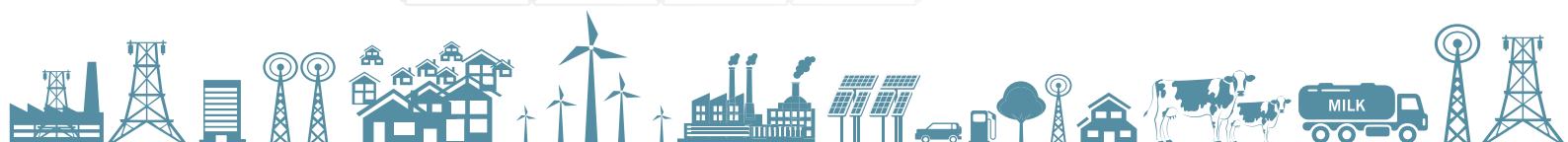
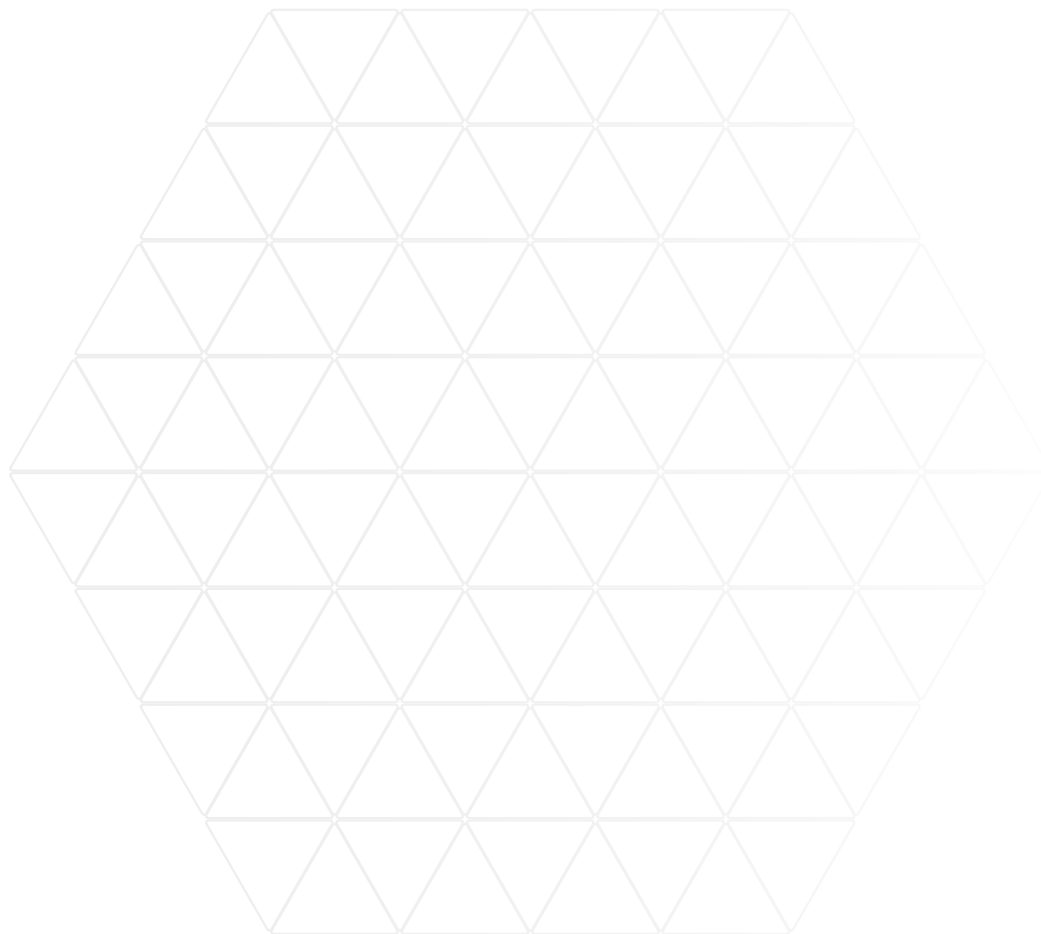

Figure 38: Chilling graph.....	125
Figure 39: MBRT after installation of remote monitoring system	126
Figure 40: Capacity control of compressor	128
Figure 41: Chilled Water Pumping Systems.....	131
Figure 42: Pump Characteristic Curve	131
Figure 43: Fabric used for biogas.....	135
Figure 44: Layout of FOV Biogas Technology.....	136
Figure 45: ETP Treatment Process	140
Figure 46: Biogas Generation and Utilization Process	141
Figure 47: Pasteurization process.....	149
Figure 48: Solar Irradiance	156
Figure 49: Average Solar Irradiance	162
Figure 50: Evacuated Tube	162
Figure 51: Solar wind hybrid system.....	167
Figure 52 Hybrid mill connected to supply	168
Figure 53 Hybrid mill connected to loads	168
Figure 54: Unit Abatement Cost - Energy Efficient Technologies	174



List of Tables

Table 1: Energy Efficiency Technologies – Attractiveness and Investment.....	24
Table 2: Dairy Infrastructure Growth	28
Table 3: Energy Consumption Overview for Dairy Plant.....	38
Table 4: Technology Status – Madhya Pradesh Dairy Cluster.....	40
Table 5: Energy Efficiency Measures in Steam Generation and Distribution Systems.....	45
Table 6: Energy Efficiency in Refrigeration Systems	46
Table 7: Energy Efficiency in Process Areas	47
Table 8: Energy Efficiency in Utilities	48
Table 9: Best Practices for Energy Efficient Operations	50
Table 10: Energy – Key Performance Indicators	52
Table 11: Case Studies for Dairy sector.....	55
Table 12: Steam requirement in plant	57
Table 13: Boiler and Fuel Parameters	58
Table 14: Boiler Efficiency	58
Table 15: Cost Benefit Analysis – Energy Efficient Boiler	60
Table 16: Vendor details – Energy Efficient Boiler.....	61
Table 17: Reference implementation: Briquette fired boiler	62
Table 18: Cost Benefit Analysis – Condensate Recovery Systems	65
Table 19: Reference Implementation – Condensate Recovery Systems.....	66
Table 20: Vendor Details – Condensate Recovery Systems	67
Table 21: Boiler details	68
Table 22: Cost Benefit Analysis – Installation Steam Operated Pumping Traps	70
Table 23: Reference Implementation – Automatic Pumping Trap.....	71
Table 24: Vendor Details – Steam Operated Pumping Traps.....	71
Table 25: Operating Parameters of compressors	72
Table 26: Comparison between screw and reciprocating compressor	73
Table 27: Cost Benefit Analysis – Installation of Screw Compressor	74
Table 28: Reference Implementation – Installation of screw refrigeration compressor.....	75
Table 29: Vendor details – Screw Compressor (Refrigeration)	76
Table 30: Operating Parameters of compressors	77
Table 31: Cost Benefit Analysis – VFD for Refrigeration Compressor	79
Table 32: Reference implementation: Installation of VFD for reciprocating chiller.....	80
Table 33: Vendor details – VFD for Refrigeration Compressor.....	81
Table 34: Chiller compressor performance.....	82
Table 35: Cost savings for high speed reciprocating compressor	83
Table 36: Reference Implementation – Installation of high-speed reciprocating compressor	84
Table 37: Vendor details: High speed reciprocating compressor	85

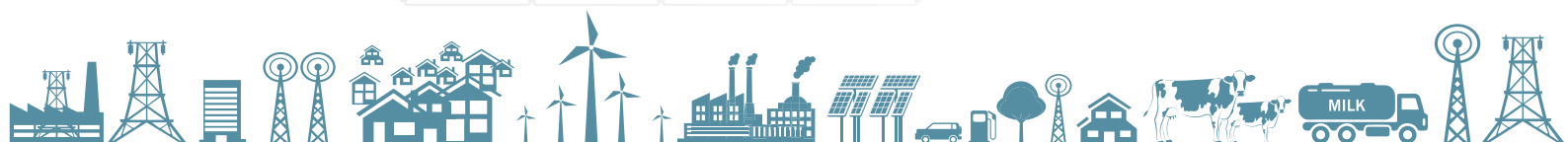

Table 38: Cost Benefit Analysis – EE agitator for IBT	87
Table 39: Reference implementation: Energy efficient agitators.....	88
Table 40: Vendor Details – EE agitator	88
Table 41: Chiller compressor performance	89
Table 42: Falling Film Chiller vs Plate Heat Exchanger.....	91
Table 43: Cost Benefit Analysis – Falling Film Chiller	91
Table 44: Reference Plant Implementation – Falling Film Chiller	93
Table 45: Vendor Details – Falling Film Chiller.....	93
Table 46: Cost Benefit Analysis – Direct Cooling in IBT	96
Table 47: Vendor details – Direct Cooling in IBT	97
Table 48: Technical specification of VAM	100
Table 49: Cost Benefit Analysis – Vapour absorption machine.....	102
Table 50: Vendor Details - VAM.....	103
Table 51: Key technical parameters of Desuperheater.....	105
Table 52: Cost Benefit Analysis – Installation of Desuperheater.....	106
Table 53: Reference Plant Implementation - De-superheater	107
Table 54: Vendor details – De-superheater for Compressors.....	108
Table 55: Electrical parameters.....	109
Table 56: Cost Benefit Analysis – kVAr Energy Compensator.....	110
Table 57: Reference Plant Implementation – kVAr Compensator	111
Table 58: Vendor Details – kVAr Energy Compensator.....	112
Table 59: Cost Benefit Analysis – VFD for chilled water pump	114
Table 60: Reference Plant Implementation – VFD for chilled water pump	115
Table 61: Vendor Details – VFD for chilled water pump	116
Table 62: Bacterial growth factor with milk temperature.....	117
Table 63: Cost Benefit Analysis – Instant Milk Cooler	120
Table 64: Reference Plant Implementation – Instant Milk Coolers.....	121
Table 65: Vendor Details – Thermal Energy Storage for BMCs	122
Table 66: Milk rating as per MBRT	123
Table 67: Cost benefit analysis - BMC remote monitoring	127
Table 68: Vendor details - BMC remote monitoring system	127
Table 69: Plant compressor loading pattern.....	128
Table 70: Cost Benefit Analysis - VFD for Air Compressor	129
Table 71: Vendor Details – VFD for Air Compressor	130
Table 72: Cost Benefit Analysis – Energy Efficient Pump	132
Table 73: Reference Plant Installation: Energy Efficient Pump Sets.....	133
Table 74: Cost Benefit Analysis – Biogas Reactor Systems	137
Table 75: Reference Plant Implementation – Biogas Reactor.....	138
Table 76: Effluent Characteristics	139
Table 77: Cost Benefit Analysis – Biogas Power Generator.....	142

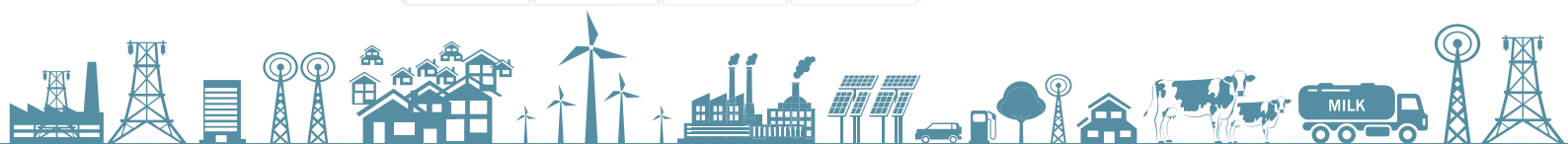
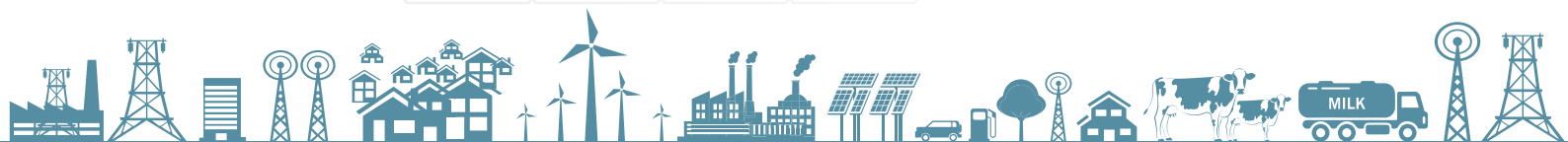
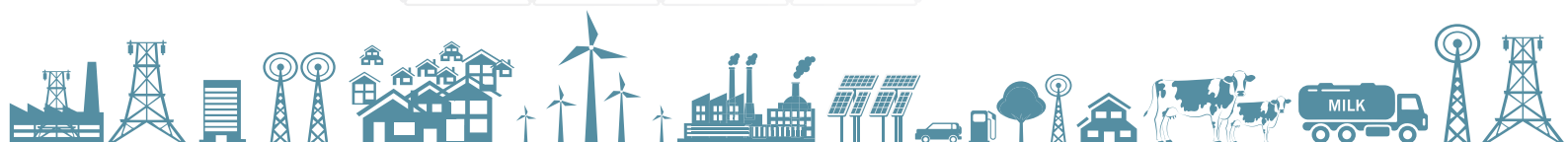

Table 78: Reference Plant Implementation – Biogas Utilization	143
Table 79: Vendor Details – Biogas Utilization – Power and CNG	144
Table 80: Cost Benefit Analysis – IOT Based Water Management System	146
Table 81: Reference Plant Implementation – IOT based water management system.....	147
Table 82: Vendor Details – IOT Based Water Management System	148
Table 83: Comparison sheet.....	150
Table 84: Cost Benefit Analysis – High regenerative efficiency Pasteurizer	151
Table 85: Vendor details - High regenerative Pasteurizer	152
Table 86: Cost benefit analysis - Preheating of milk in curd Pasteurizer.....	154
Table 87: Reference implementation - Preheating of incoming milk in curd Pasteurizer	155
Table 88: Vendor details: Plate heat exchanger.....	155
Table 89: Site Specification – For Solar PV.....	156
Table 90: Features/requirements for Grid Connected Solar PV Systems (Rooftop)	157
Table 91: Cost Benefit Analysis – Solar PV Systems	159
Table 92: Reference Plant Implementation – Solar PV Systems.....	159
Table 93: Vendor Details – Solar PV	160
Table 94: Boiler Details.....	161
Table 95: Site specifications	161
Table 96: Water Quality Requirement for Solar Thermal.....	163
Table 97: Cost Benefit Analysis – Solar Thermal Systems.....	164
Table 98: Reference Plant Implementation – Solar Thermal System	166
Table 100: Vendor Details – Solar Thermal Systems	166
Table 101: Cost Benefit Analysis – Solar Wind Hybrid Systems.....	169
Table 102: Vendor Details – Solar-Wind Hybrid Systems	170
Table 103: Summary of Energy conservation measures.....	172



List of Abbreviations

AC	Alternating Current
AHU	Air Handling Unit
APFC	Automatic Power Factor Controller
BEE	Bureau of Energy Efficiency
BEP	Best Efficiency Point
BLDC	Brushless Direct Current
BMC	Bulk Milk Cooler
BOD	Biological Oxygen Demand
CAGR	Compound Annual Growth Rate
CHW	Chilled Water
CII	Confederation of Indian Industry
CIP	Cleaning in Place
COD	Chemical Oxygen Demand
COP	Coefficient of Performance
CPD	Central Products Dairy
CT	Cooling Tower
CUF	Capacity Utilisation Factor
DAHD	Department of Animal Husbandry and Dairying
DC	Direct Current
DG	Diesel Generator
DPR	Detailed Project Report
ERCMPU	Ernakulam Cooperative Milk Producers' Union
ETC	Evacuated Tube Collector
ETP	Effluent Treatment Plant
FAO	Food and Agricultural Organization
FCU	Fan Coil Unit
FFC	Falling Film Chiller
FO	Furnace Oil
GCRT	Grid connected Rooftop



GCV	Gross Calorific Value
GDP	Gross Domestic Product
GEF	Global Environmental Facility
GHG	Greenhouse Gas
GI	Galvanized Iron
GLPCL	Gujarat Livelihood Promotion Company Limited
HSD	High Speed Diesel
HTST	High Temperature Short Time
HVAC	Heating Ventilation and Air Conditioning
IBT	Ice Bank Tank
ID	Induced Draft
IFC	Intelligent Flow Controller
IIoT	Industrial Internet of Things
IMC	Instant Milk Cooler
INR	Indian Rupee
IoT	Internet of Things
IRR	Internal Rate of Return
ISO	International Standards Organization
LBNL	Lawrence Berkeley National Laboratory
LED	Light Emitting Diode
LP	Low Pressure
LSP	Local Service Provider
MBR	Membrane Bio Reactor
MBRT	Methylene Blue Dye Reduction Test
MCC	Milk Chilling Centre
MPCDF	Madhya Pradesh Cooperative Dairy Federation
MNRE	Ministry of New and Renewable Energy
MPPT	Maximum Power Point Tracker
MS	Mild Steel
MSME	Micro, Small and Medium Enterprises
NB	Nominal Bore
NDDDB	National Dairy Development Board

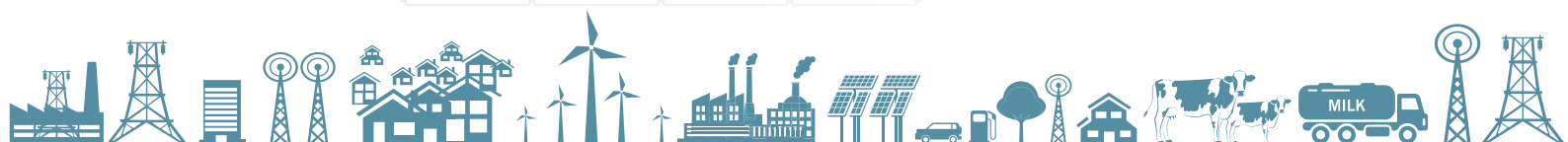

NG	Natural Gas
NPV	Net Present Value
O&M	Operation and Maintenance
OEM	Original Equipment Manufacturer
OHT	Overhead Tank
PCU	Power Conditioning Unit
PF	Power Factor
PHE	Plate Heat Exchanger
PID	Proportional Integral Derivative
PLC	Programmable Logic Controller
PMU	Project Management Unit
PNG	Piped Natural Gas
PRV	Pressure Reducing Valve
PV	Photovoltaic
RE	Renewable Energy
RO	Reverse Osmosis
RTD	Resistance Temperature Detector
SEC	Specific Energy Consumption
SNF	Solid Non Fat
SOPT	Steam Operated Pumping Trap
SPV	Solar Photovoltaic
TCV	Temperature Control Valve
TDS	Total Dissolved Solids
TOE	Tons of Oil Equivalent
UAC	Unit Abatement Cost
UASB	Up flow Anaerobic Sludge Blanket
UHT	Ultra-High Temperature
UNIDO	United Nations Industrial Development Organization
UOM	Unit of Measurement
VAM	Vapour Absorption Machine
VFD	Variable Frequency Drive
WHR	Waste Heat Recovery

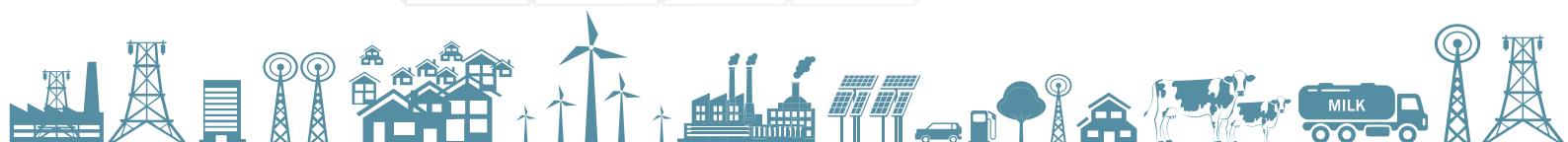

Unit of Measurements

cfm	Cubic Feet per Minute
gm	Grams
HP	Horse Power
kg	Kilogram
kg/cm ²	kilo gram per square centimetre area
kJ	Kilo Joule
kl	Kilo Litre
kl/hr	Kilo Litre per Hour
km	Kilometre
kVAr	Reactive Power
kW	Kilo Watt
kWh	Kilo Watt Hour
kWp	Kilowatt Peak
LLPD	Lakh Litre per Day
°C	Degree Celsius
ppm	parts per million
psi	Pounds per Square Inch
INR	Rupees
TCO ₂	Tons of Carbon dioxide
TDS	Total Dissolved Solids
THD	Total Harmonic Distortion
TOE	Tons of Oil Equivalent
TPD	Tons Per Day
TPH	Tons per Hour
TR	Tons of Refrigeration

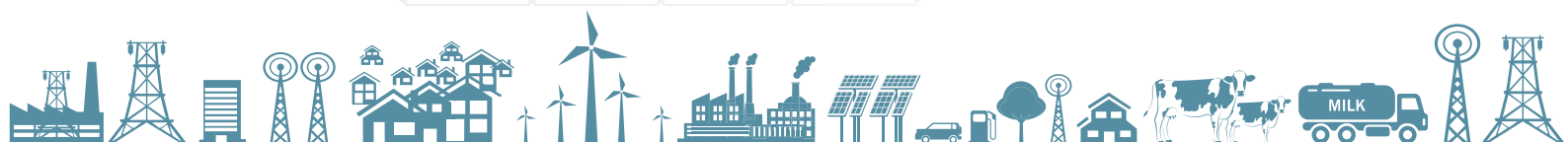



This Page Intentionally Left Blank

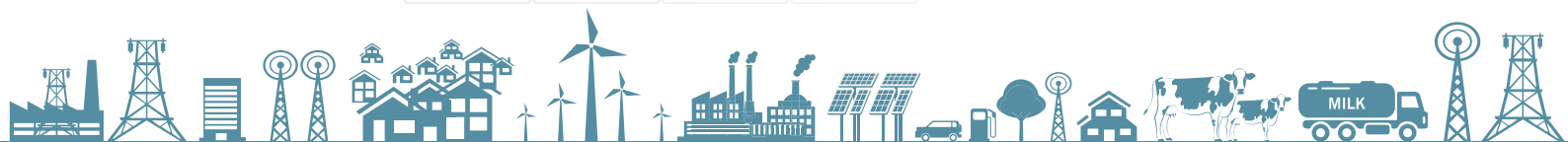

The background is a top-down view of a wooden desk with various engineering and technical tools. On the left, there are two hard hats, one red and one yellow. In the top right, there are several rolled-up white blueprints with technical drawings. Below them is a grey scientific calculator. A pencil lies horizontally across the middle right. In the bottom right, there is a magnifying glass, a pair of compasses, and another calculator. At the bottom center, there is a yellow measuring tape. The entire scene is overlaid with a semi-transparent teal banner containing the title text.

About Project & Technology Compendium

About the Project

The United Nations Industrial Development Organization (UNIDO), in collaboration with the Bureau of Energy Efficiency (BEE), a statutory body under the Ministry of Power, Government of India, is executing a Global Environment Facility (GEF) funded national project titled 'Promoting energy efficiency and renewable energy in selected MSME clusters in India'. The project was operational in 12 MSME clusters across India in five sectors, respectively: Brass (Jamnagar); Ceramics (Khurja, Thangadh and Morbi); Dairy (Gujarat, Sikkim and Kerala); Foundry (Belgaum, Coimbatore and Indore); Hand Tools (Jalandhar and Nagaur). The Project has now scaled-up and expanded its activities to 11 new clusters, namely in Dairy (Tamil Nadu, Odisha, Madhya Pradesh, Andhra Pradesh & Telangana, Haryana, Maharashtra & Punjab), Foundry (Ahmedabad & Howrah), Ceramic (Himmatnagar) Mixed Cluster (Indore & Sikkim) in order to reach out to MSME's at national level.

This project so far has supported 303 MSME units in implementing 603 Energy conservation Measures and thus resulted in reduction of about 10,850 TOE energy consumption and avoided 62,868 metric tons of CO₂ emissions as on date.

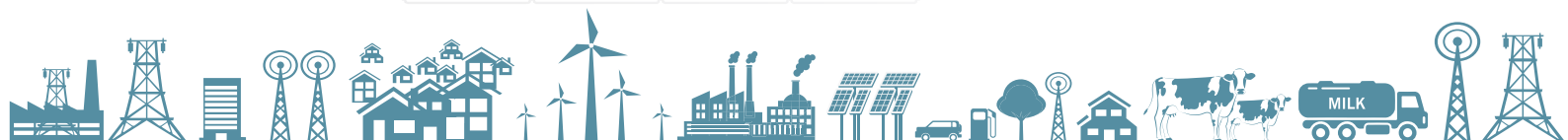
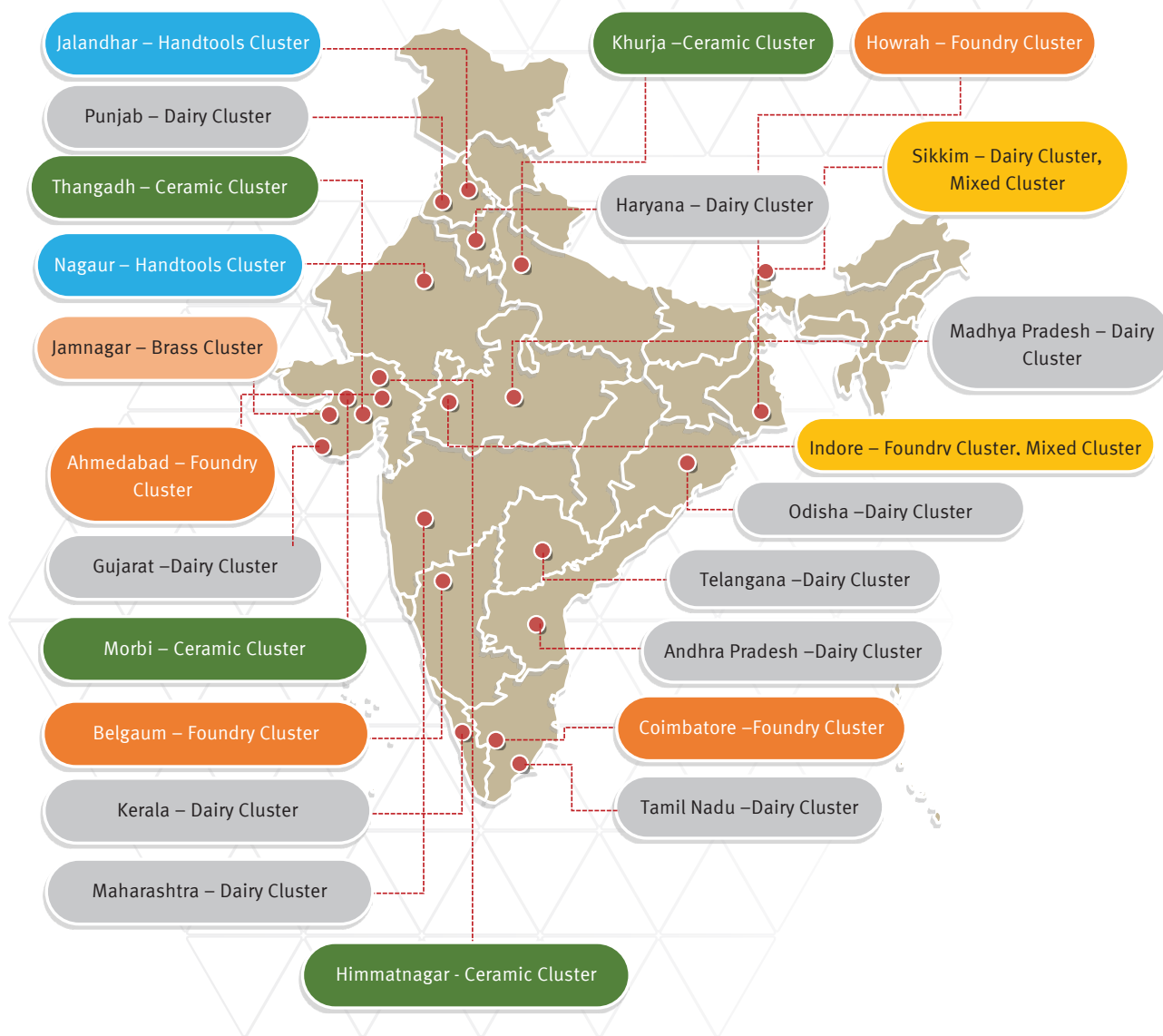

The key components of the project include:

- ❖ Increasing capacity of suppliers of EE/RE product suppliers / service providers / finance providers
- ❖ Increasing the level of end user demand and implementation of EE and RE technologies and practices by MSMEs.
- ❖ Scaling up of the project to more clusters across India.
- ❖ Strengthening policy, institutional and decision-making frameworks.
- ❖ Significant progress has been made in the project and it is now proposed to scale up and expand. The activities envisaged under the scaling up phase of the project include:
 - ✧ Establishment of field level Project Management Cell (PMC)
 - ✧ Organizing cluster level awareness program and identification of potential MSME enterprises
 - ✧ Development of cluster specific EE and RE based technology compendiums
 - ✧ Providing implementation support and other related activities to the identified enterprises

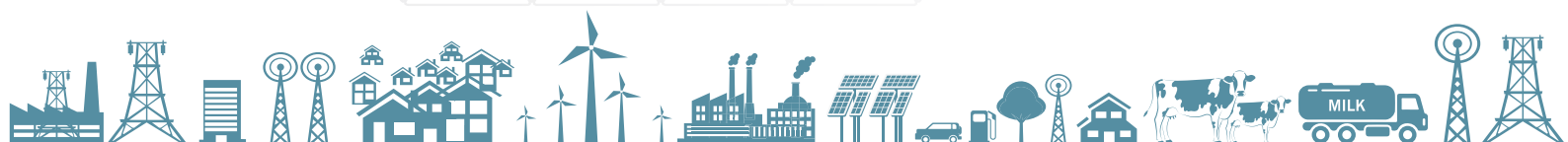

About the Technology Compendium

The dairy industry in India today faces challenges and opportunities resulting from rising energy costs, environmental concerns and competitiveness. Dairy processing in dairy value chain consumes more energy than any other operation across the value chain. The dairy uses energy for cooling, heating and in operation of various equipment such as refrigeration, boilers, compressors, etc. Over the years, there has been significant technology improvement in process and utilities area and dairies have been able to improve the energy efficiency in their operations. However, various opportunities still exist for dairies to improve their energy efficiency. To be competitive and have environment friendly operations, energy efficiency is crucial.

The technology compendium is prepared with the objective of accelerating the adoption of energy efficient technologies and practices in the dairy industry, and it focuses on dairy equipment upgrades, new technologies and practices for improving energy efficiency. The technology case studies included in the compendium provide all the necessary information to enable dairies to refer and implement it in their operations. The case studies are supported by technology background, baseline scenario, merits, challenges, technical feasibility, financial feasibility and technology provider details. The opportunities presented in this compendium are developed for dairy processing units but may be applicable across the dairy value chain. The energy efficiency measures included in the report cover more than 90% of energy consumption in a dairy unit.

- ❖ The objective of this compendium is to act as a catalyst to facilitate dairies towards continuously improving their energy performance, thereby achieving world class levels (with a thrust on energy & environment management).
- ❖ The compendium includes general energy efficiency options as well as specific case studies on applicable technology upgradation projects which can result in significant energy efficiency improvements.
- ❖ The suggested best practices may be considered for implementation only after detailed evaluation and fine-tuning requirements of existing units.
- ❖ In the wide spectrum of technologies and equipment applicable for dairy sector for energy efficiency, it is difficult to include all the energy conservation aspects in this manual. However, an attempt has been made to include the more common implementable technologies across all the dairy units.
- ❖ The user of the compendium has to fine-tune the energy efficiency measures suggested in the compendium to their specific plant requirements, to achieve maximum benefits.
- ❖ The technologies collated in the compendium may not necessarily be the ultimate solution as the energy efficiency through technology upgradation is a continuous process and will eventually move towards better efficiency with advancement in technology.
- ❖ The Madhya Pradesh dairy industry should therefore view this manual positively and utilise this opportunity to implement the best operating practices and energy saving ideas during design and operations, to facilitate achieving world class energy efficiency standards.

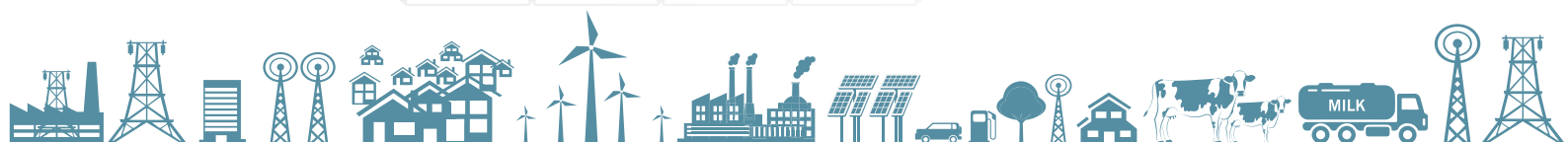

The background of the page is a photograph of industrial machinery, including large pipes, valves with handwheels, and pumps. The image is overlaid with a semi-transparent blue horizontal band. The text 'Executive Summary' is centered within this band in a white, bold, sans-serif font.

Executive Summary

Executive Summary

The United Nations Industrial Development Organization (UNIDO), in collaboration with the Bureau of Energy Efficiency (BEE), a statutory body under the Ministry of Power, Government of India, is executing a Global Environment Facility (GEF) funded national project called ‘Promoting energy efficiency and renewable energy in selected MSME clusters in India’. The project execution is planned in multiple phases.

The aim of the Phase-I of the project was to develop and promote a market environment for introducing energy efficiency and enhanced use of renewable energy technologies in process applications in the above mentioned (12) selected energy-intensive MSME clusters in India, with feasibility for expansion to more clusters. Phase-II of the project is to scale up and expand the project activities to a greater number of enterprises in existing clusters, as well as 11 new clusters, for better implementation of energy efficiency technologies and practices.

Efficient use of energy in any facility is invariably the most important strategic area for manageability of cost or potential cost savings. Awareness of the personnel, especially operators in the facility becomes a significant factor for the proper implementation of energy conservation initiatives. With this context, this Technology Compendium has been prepared, which comprises of various technologies and best practices to save energy.

The information in this compendium is intended to help the dairy managers in the Madhya Pradesh Dairy Unions to reduce energy consumption in a cost-effective manner while maintaining the quality of products manufactured. Further analysis on the economics of all measures—as well as on their applicability to different production practices—is needed to assess their cost effectiveness at individual dairy units. Additionally, this compendium shall also serve the purpose of tapping the opportunities to significantly reduce energy consumption. Further, this shall also serve as a guide for estimating the feasibility of energy saving project at the first place and ensure accelerated implementation.

Chapter 1 of the compendium provides an overview of Indian Dairy and Madhya Pradesh Dairy Cluster.

Chapter 2 focuses on a brief overview of dairy process and energy consumption in dairy units and includes technology status/mapping of the dairy cluster.

Chapter 3 focuses on importance of energy efficiency in dairy industry, and some of the common measures applicable in different sections of the dairy unit. The energy efficiency measures are included for more than 90% of energy consumption areas in a dairy plant, such as refrigeration, steam systems, process, utilities and utilization of renewable energy. The chapter also includes some of the best practices and key indicators that the plant should follow and monitor to maintain the energy efficiency levels in different energy consuming areas.

Chapter 4 provides detailed case studies for some of high impact and implementable energy efficient technologies in dairy units. In this chapter, 21 case studies have been included in areas such as refrigeration, steam systems, utilities, renewable energy, etc. These technologies are

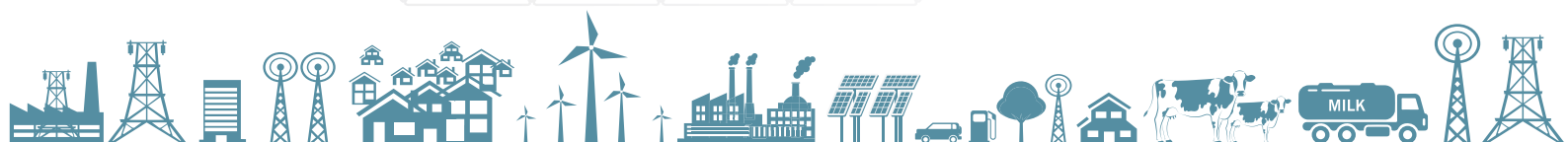

described in detail, such as baseline scenario, proposed scenario, merits, demerits, etc., and wherever possible, a case reference from a dairy unit that has implemented the technology has been included. In most of the examples, typical energy saving data, GHG emission reduction, investments, payback period, etc., have been highlighted. Energy saving potential in this sector is estimated to be about 10-15% without (or with marginal) investment, and an additional 15% with investment. High potential for improving energy efficiency in dairies exists in the areas of heating and cooling via adoption of technologies such as co-generation, Desuperheater, evaporative cooling systems, utilization of renewable energy, biomass fired boilers and increased automation.

The following table summarizes list of technologies included in the compendium:

Table 1: Energy Efficiency Technologies – Attractiveness and Investment

Sr. No	Madhya Pradesh	Internal Rate of Return (IRR %)	Payback (months)	Unit Abatement Cost (INR Lakh / TOE)
1	Conversion of Furnace Oil Fired Boiler to Biomass Fired Boiler	84.0	20.0	0.3
2	Condensate Recovery System	143.6	10.0	0.1
3	Steam Operated Pumping Traps	58.8	30.0	0.4
4	Installation of screw refrigeration compressor	44.0	41.0	2.2
5	VFD in Reciprocating Chiller Compressor	73.0	23.0	1.2
6	Energy Efficient Agitator for IBT	171.0	13.0	0.7
7	Falling Film Chiller	121.3	24.0	1.4
8	Direct Cooling Method – IBT	56.6	31.0	2.5
9	Double effect steam driven vapour absorption chiller heater	43.9	40.0	-
10	Desuperheater for Chiller Compressors	53.0	34.0	0.4
11	kVAR Energy Compensator for Chiller Compressor	83.6	20.0	1.4
12	VFD for chilled water pumps	4.6	6.0	0.2
13	Thermal Energy Storage for BMC	246.1	6.0	1.3
14	BMC Remote Monitoring System	-	-	-
15	VFD for air Compressor	142.0	11.0	0.6
16	Energy Efficient Pumps	66.7	17.0	0.6
17	Package Type Biogas Reactor	62.3	27.0	1.0
18	Methane capture from dairy effluents	71.4	24.0	1.5
19	IoT based Water Management System	181.1	8.0	-
20	Installation of High Regenerating Efficiency Pasteurizer	176.3	11.0	0.2

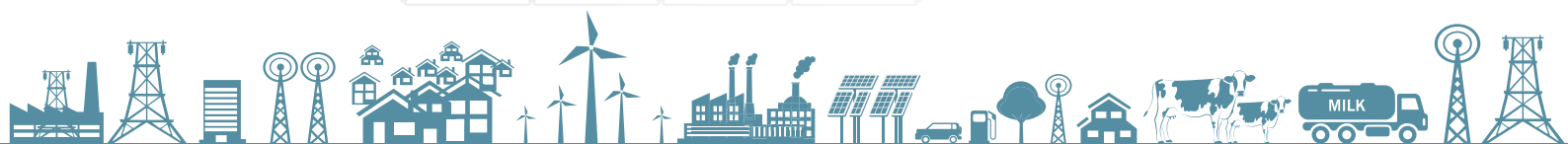

Sr. No	Madhya Pradesh	Internal Rate of Return (IRR %)	Payback (months)	Unit Abatement Cost (INR Lakh / TOE)
21	Preheating of incoming milk in curd Pasteurizer	72.7	23.0	0.3
22	Solar rooftop system	19.8	57.0	3.6
23	Solar Thermal System	48.2	37.0	0.1
24	Solar-Wind Hybrid system	20.9	63.0	4.8

The Madhya Pradesh dairy industry should view this manual positively and utilize this opportunity to implement the best operating practices and energy saving ideas during design and operations stages, and thus work towards achieving world class energy efficiency.

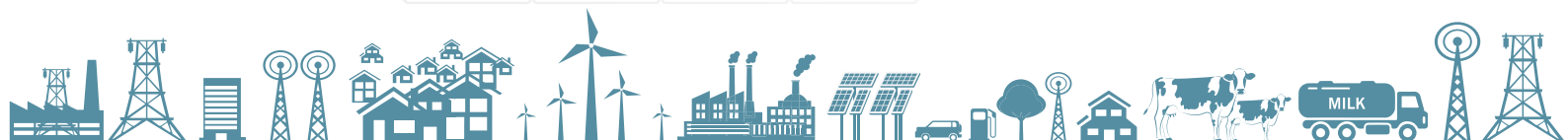



1. Indian Dairy Industry

1. Indian Dairy Industry

1.1 Background

India is the world’s largest milk producer and is responsible for 21% of global milk production (FAO, 2019). The dairy sector in India has grown exponentially in the last five decades, and the ‘White Revolution’ has helped India transform from a milk deficit nation to a milk surplus country. In the year 1950, India’s milk production was a mere 17 million tons per year, and it has increased to 176.5 million tons in 2017-18 (NDDDB, 2019). The dairy sector has grown at a CAGR of 4.18% every year since 1990, and in the same duration, the per capita milk availability has improved from 178 grams/day to 375 grams/day, as of 2017-18 (NDDDB, 2019). The following graphs highlight the growth in milk production and per capita milk availability in the country:

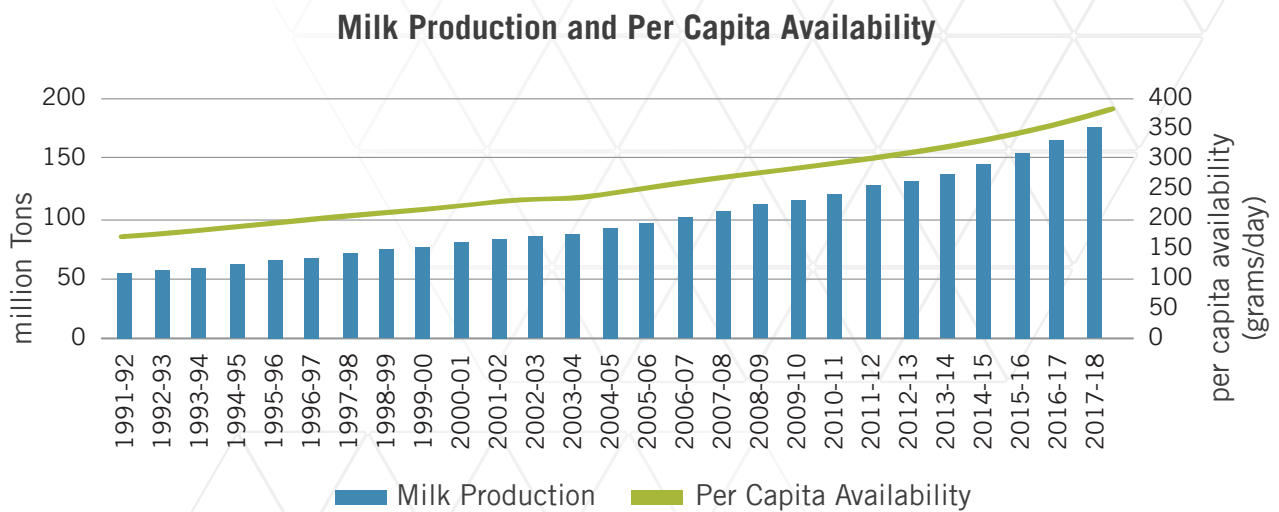

Figure 1: Milk Production and Per Capita Availability in Country (NDDDB, 2019)

Among the various states in India, the five largest milk producers are Uttar Pradesh, Rajasthan, Madhya Pradesh, Andhra Pradesh, and Gujarat, and these states make up for 53% of milk production in India in 2017-18.

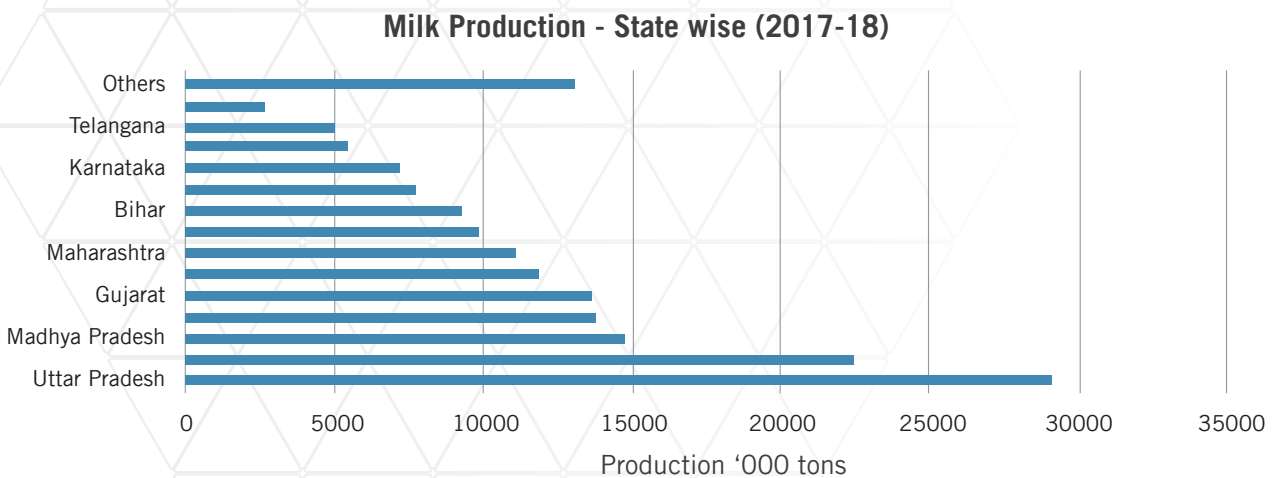
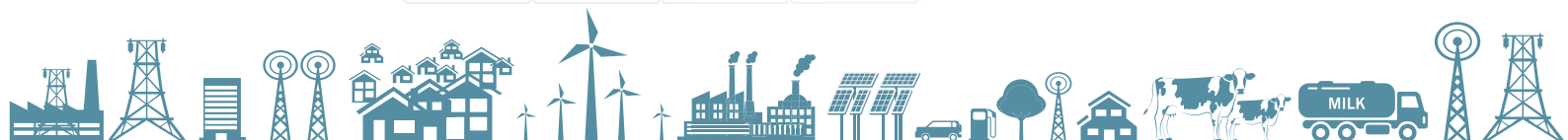

Figure 2: Milk Production – state wise



1.2 Dairy Sector Growth Prospects

The dairy sector has also played a critical role in socio-economic development of the country, as it provides employment and entrepreneurship opportunities to millions of households in the country. The livestock, which is an important constituent within the dairy sector, is also important as it contributes to 67% of the output value of the livestock sub-sector under the agriculture sector (DAHD, 2018).

The key growth drivers for dairy sector are population growth, income growth and urbanization, and it is expected that these factors will drive India's milk consumption to 300 million tons by 2023-24, and will also result in increased per capita availability of milk to 592 grams/day (DAHD, 2018). Thus, there is a significant growth potential in the dairy sector for the coming years. The Government of India in 2018 announced the National Action for Dairy Development to tap the growth opportunity by addressing the gaps in infrastructure required to handle and process the milk to not only meet the growing demand but also for doubling the farmers' income.

To tap the growth opportunity, it is important to have enough dairy infrastructure, such as chilling centres, milk processing facilities, as well as value-added products. As highlighted in the National Action Plan for Dairy Development, there is an urgent need to modernize the existing infrastructure, and to develop new infrastructure in the dairy sector, in order to achieve the target of 300 million tons of production and processing in the country by 2023-24. The following table highlights the existing capacity of dairy infrastructure and targets envisaged as per the plan for 2023-24.

Table 2: Dairy Infrastructure Growth

Dairy Infrastructure Growth				
Sr. No	Particulars	UOM	2015-16	2023-24
1	Processing Capacity	LLPD	1,420	5,345
2	Chilling Capacity	LLPD	767	4,260
3	Value added products	TPD	7,918	20,534
4	Milk Powder	TPD	2,961	8,401
5	Cattle feed plant	TPD	15,562	21,300

To meet the gap in the infrastructure, it is estimated that INR 1,27,455 crore of investment is required by cooperatives, producers and the private sector. Among these, the major investment would be driven by milk processing and milk chilling infrastructures. (DAHD, 2018).

Thus, the dairy sector is bound to have an accelerated growth in the coming years and would contribute significantly in socio-economic development of the country, and most importantly, in the development of rural India.

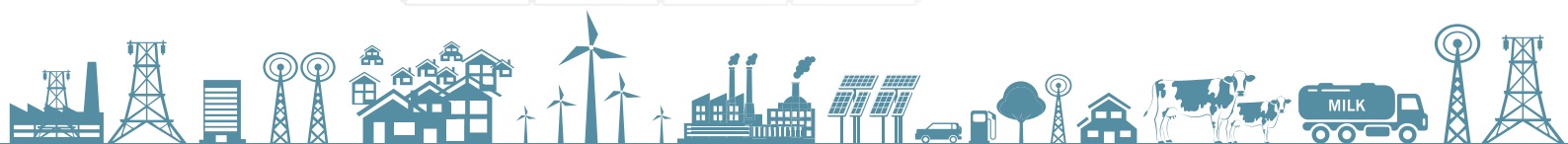

1.3 Madhya Pradesh Dairy Cluster

Madhya Pradesh is one among the large milk producing state in India, in 2017-18 the milk production in state was around 15.911 million tones and was responsible for 8.5% of the country’s total production (NDDDB, 2019). The graph below shows the increase of milk production during the last 7 years:

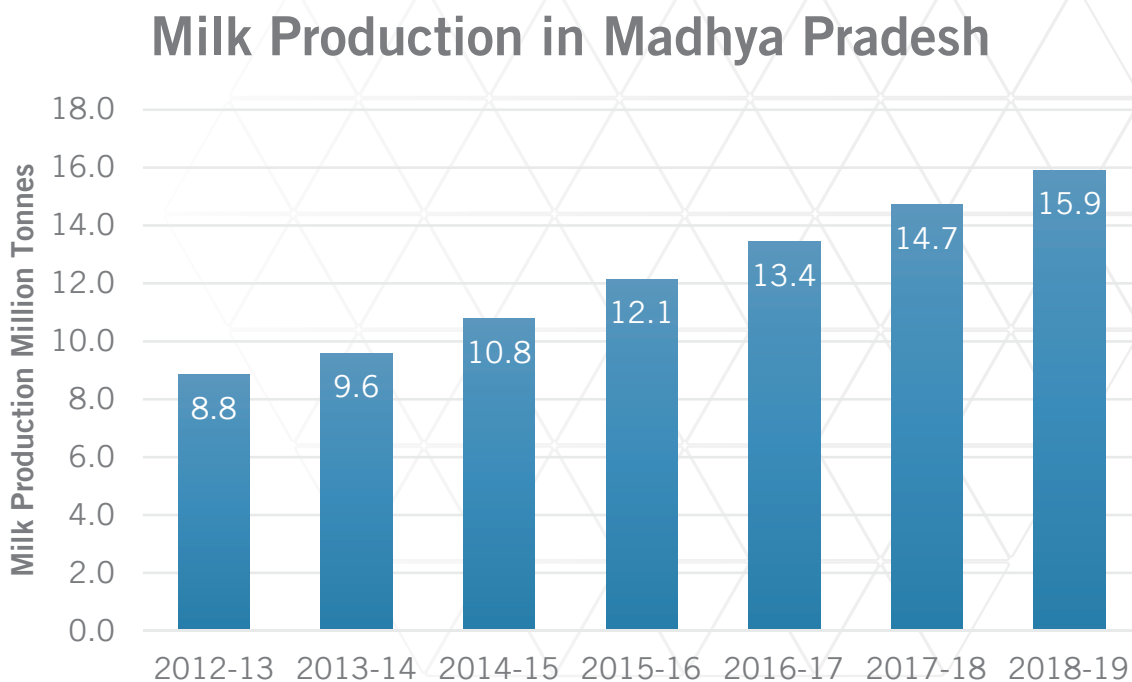

Figure 3: Annual milk production over the last few years

The dairy sector in Madhya Pradesh has evolved over the time and current shape & form of the dairy sector in Madhya Pradesh started with establishment of Madhya Pradesh Cooperative Dairy Federation (MPCDF). The MPCDF was established as a three-tiered organization.

MP State Cooperative Dairy Federation (MPCDF) is the apex level organization in the system of famous ‘Anand’ pattern dairy cooperative organization in Madhya Pradesh. At the first level there are 6897 functional Dairy Cooperative Society (DCSs) and at the second level there are 6 cooperative milk union.

The infrastructure available with the milk union under cooperative sector in the state can be summarized as hereunder:

- ❖ 6 Milk Unions
- ❖ 6897 Functional Dairy Cooperative Societies
- ❖ 603 Bulk Milk Coolers of 9.88 LLPD capacity
- ❖ 59 Chilling Centre of 6.87 LLPD capacity
- ❖ 6 Main Dairy Plants of 13.70 LLPD capacity
- ❖ 10 Mini Dairy Plants of 2.53 LLPD Capacity
- ❖ 2 Powder Plants 20 MTPD capacity
- ❖ 5 Cattle feed plants of 550 MTPD capacity

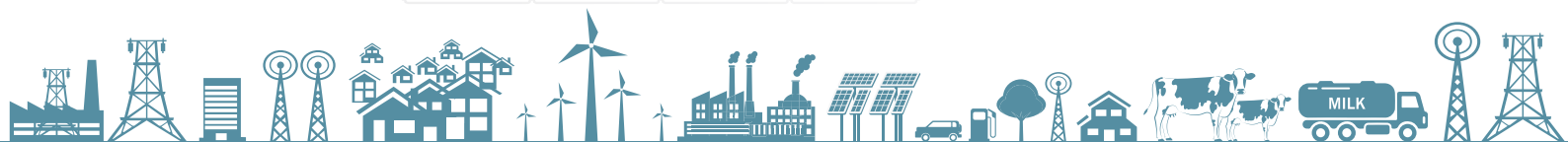

For consumers, pasteurized liquid milk of various qualities like Full Cream, Standard, Toned, Double Toned, Cow, Chah, Chai Special and Skim in sachets are marketed in the nearby cities and towns by all the individual Milk Unions (Bhopal, Indore, Ujjain, Gwalior, Jabalpur & Sagar) under the brand name of ‘Sanchi’. They also manufacture a whole range of milk products like Ghee, Table Butter, Shrikhand, Butter Milk, Flavoured Milk (in bottle and sachets), Sweet Curd, Plain Curd, Peda, Plain & Salted Butter Milk, Paneer, Chhena Kheer, Probiotic Curd, Nariyal Barfi, Milk Cake, Rasgulla, Gulab Jamun, Gulab Jamun Mix, Coffee Mix, etc., to cater to their local market .

During 2018-19 average milk production of milk union was 10.11 lakh kg per day and average packet sale was 7.40 lakh litres per day.

The dairy sector in Madhya Pradesh has a three-tiered structure, at the village level the Village Milk Co-operative Societies have the local milk producers as its members. These Village Co-operatives unite at Regional level to form Regional Co-operative Milk Producers’ Unions and further these Regional Unions federate at the State level to form Apex Federation.

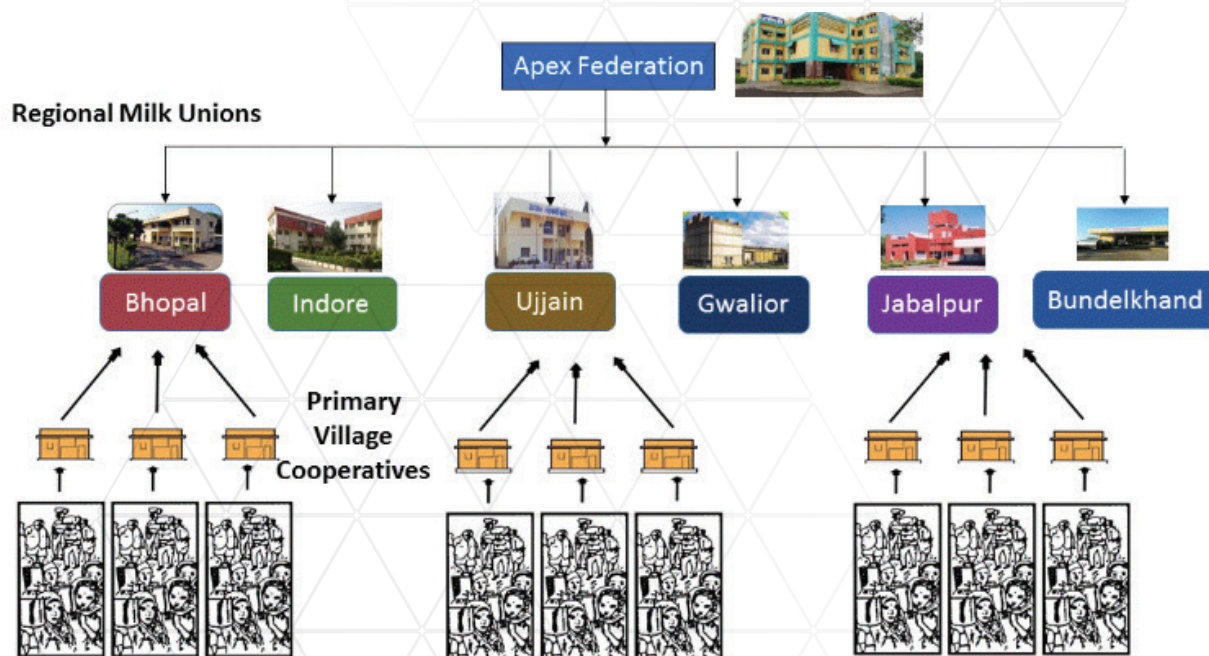
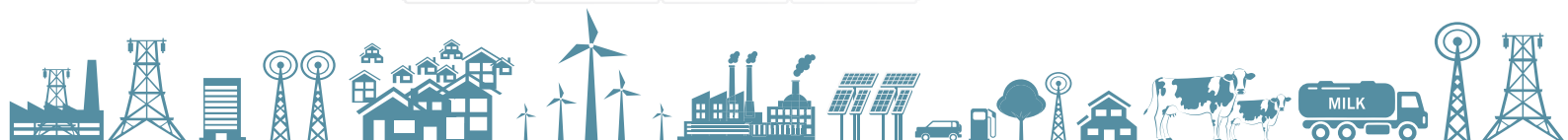

Figure 4: Dairy Institutional Structure – Madhya Pradesh



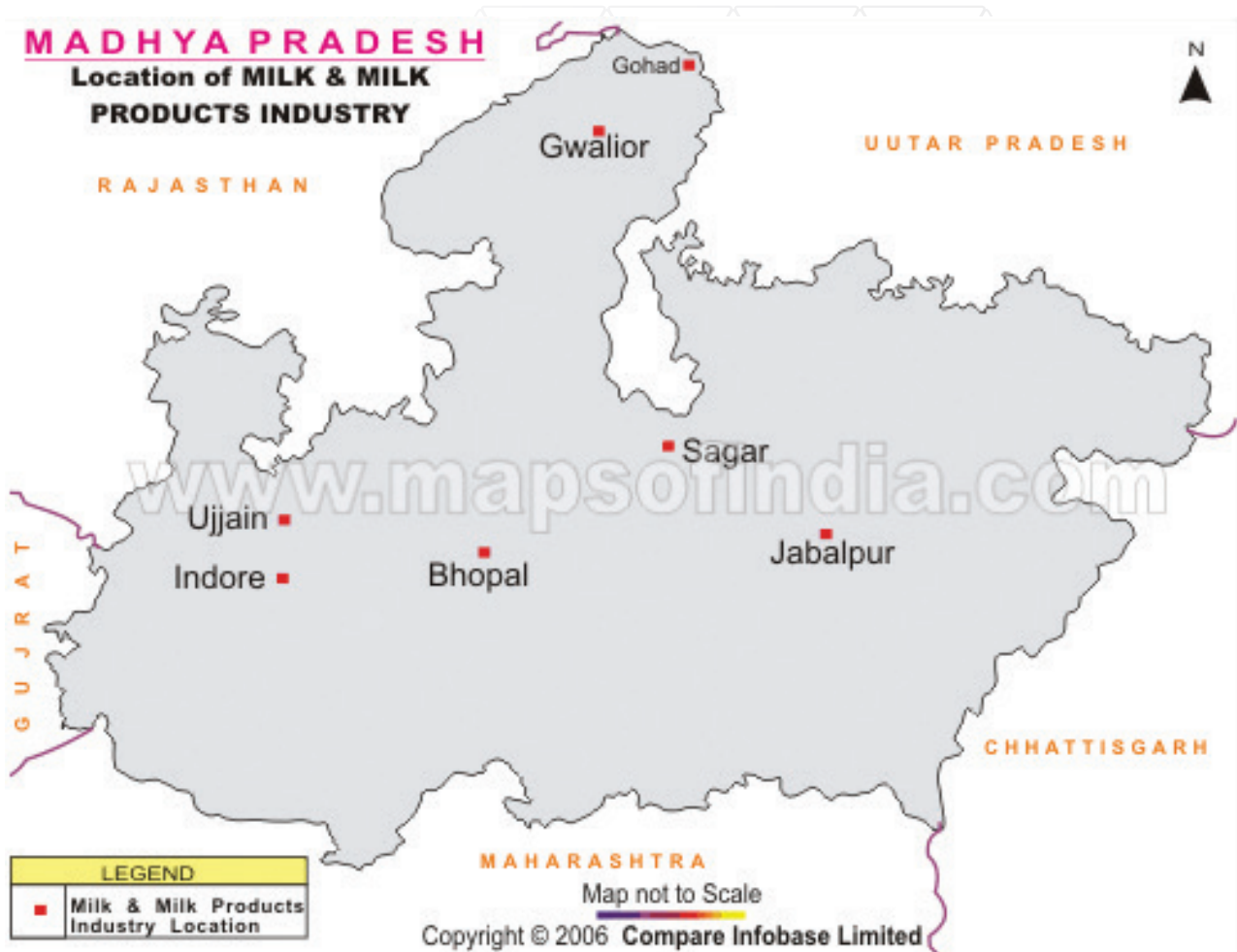
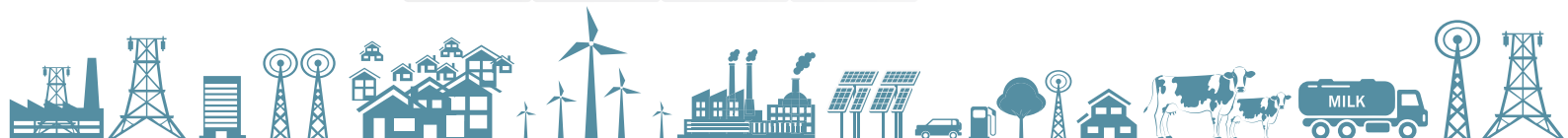
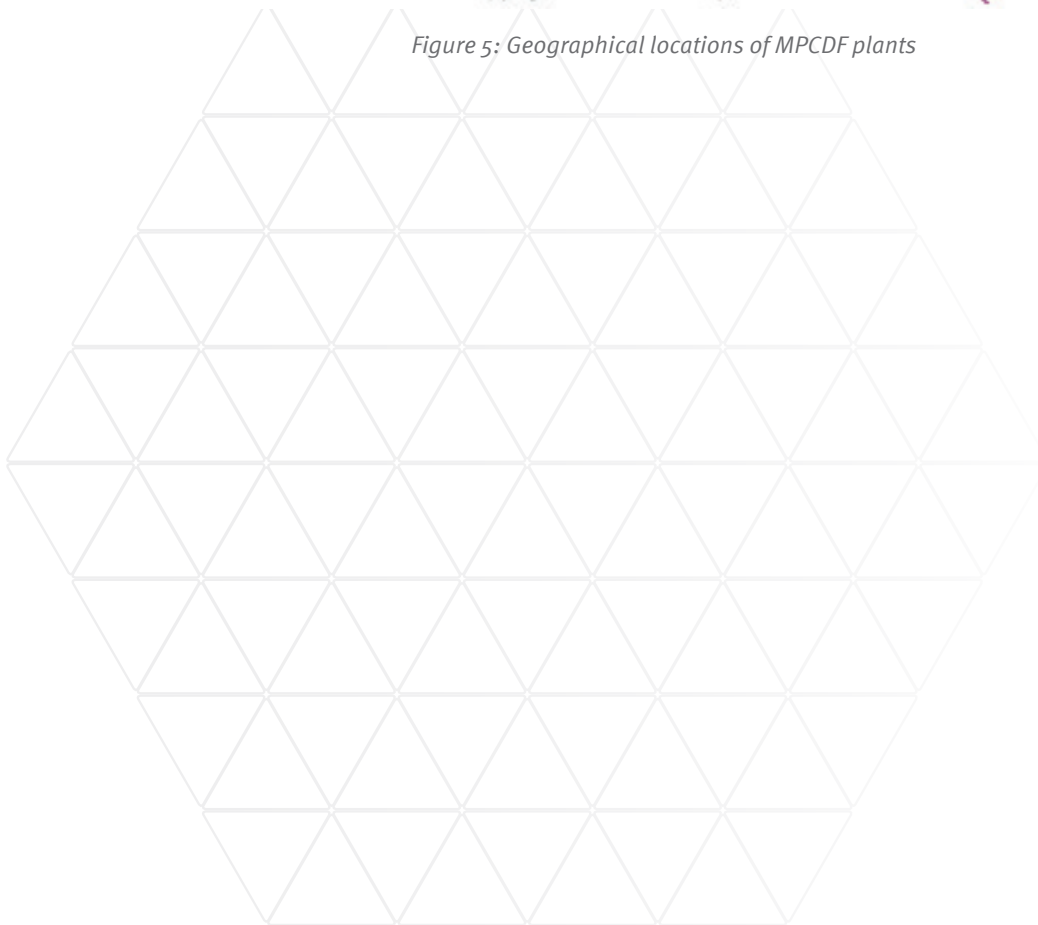

Figure 5: Geographical locations of MPCDF plants





2. Dairy Process

2. Dairy Process

2.1 Dairy Sector Overview

Milk is one of the staple foods in India, and it is highly nutritious but also has a short shelf life and thus requires special handling and processing for delivery to end consumers. As milk is an excellent medium for the growth of microorganisms and since that can cause spoilage and health impact on consumers, special treatment and processing measures are undertaken to preserve its nutritious value while extending its shelf life. The following figure indicates the value chain of the dairy industry, from raw milk to the final products delivered to consumers.

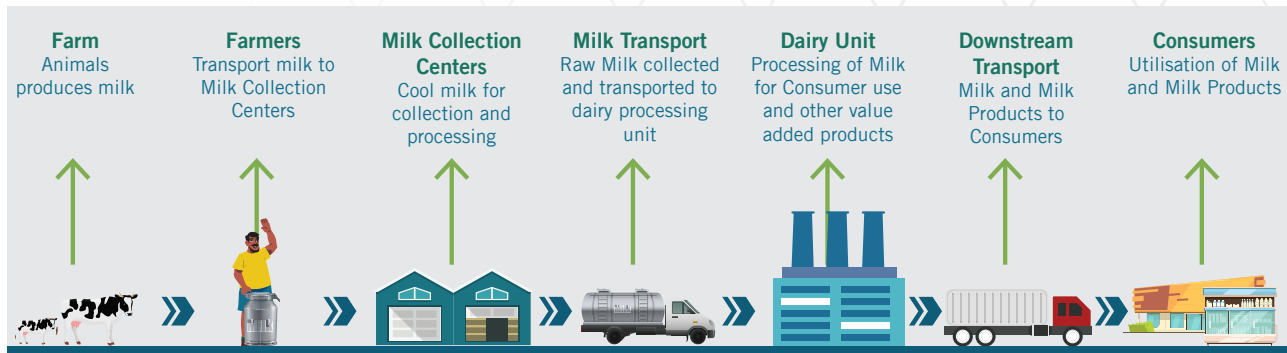

Figure 6: Milk Processing Value Chain

There are two major operations in milk processing: (i) Milk Chilling Centers (ii) Dairies.

- I) **Farming:** The milk is produced from milch animals and is taken care of by the farming community. These farming communities will collect milk and take it to the milk collection centers.
- II) **Milk Chilling Centers (MCC)/Bulk Milk Coolers (BMC):** The milk collected from different locations is first chilled in MCCs/BMCs. The milk is stored at lower temperatures so that it does not spoil and can be further transported to processing. Chilled milk is graded, weighed, sampled and dispatched in tankers for further processing.
- III) **Dairies:** The dairies are the critical link in this value chain, as they connect farmers and consumers. At the dairies, the milk is collected and processed to prevent microorganism growth, and converted into value-added products, such as curd, cream, paneer, cheese, butter, etc. The dairy process mainly involves heating and cooling, which is used in processes like pasteurization, homogenizing, CIP, etc.
- IV) **Downstream Transport:** Once milk is processed, the products are packed and transported to the retail outlets or to the consumers for further value addition or final consumption.
- V) **Consumers:** The consumers utilize the milk and milk products as nutritious products.

2.2 Overview: Process Flow in Dairy Plant

The processing techniques that are employed by dairy plants are as diverse as the variety of products manufactured by the industry. The choice of individual processes and process sequence depends heavily on the product being manufactured. In addition, for any given product, the choice of processes and process sequence can vary from facility to facility. There are many unit processes (i.e., discrete processing steps) that are common across the industry. Raw material specific processes such as pasteurization, homogenization, and cold storage can be found in nearly every dairy processing facility. Furthermore, there are many end-product specific processes such as cream, butter, condensed, and evaporated dairy products. Thus, while there is a diversity of processing techniques employed across the industry, a core group of unit processes exists to provide the basic building blocks for process sequences employed in nearly every dairy processing facility, as shown in the figure below:

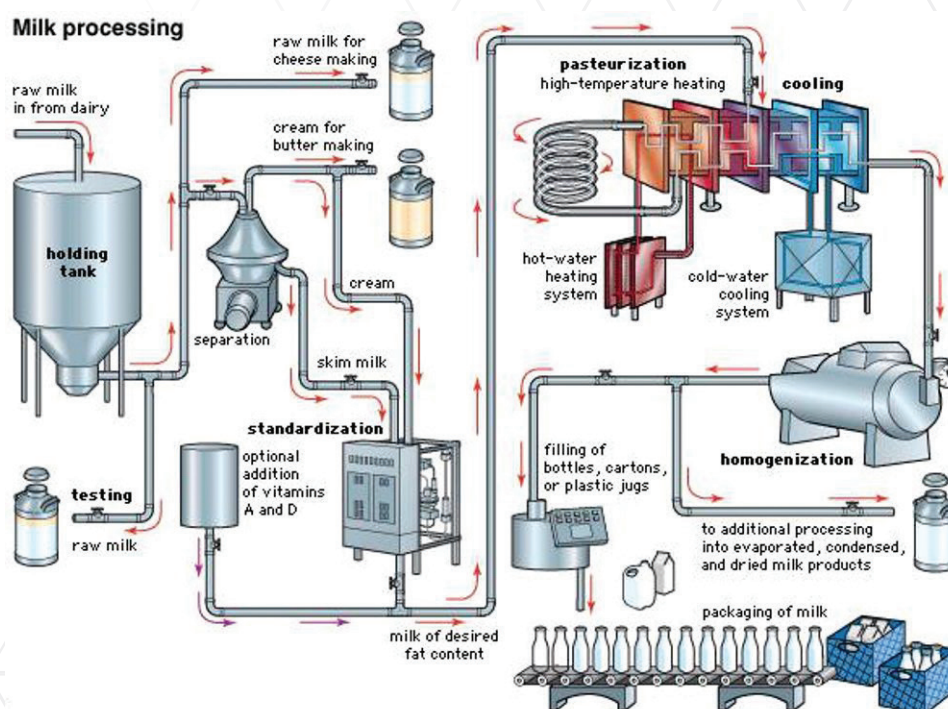

Figure 7: Milk Processing Flow

Receiving Milk at Dairy

All dairy products start with receiving raw milk from the farm. The raw milk generally is transported by way of tanker trucks and is already refrigerated to 7 degree centigrade (°C). When the raw milk is unloaded into the processing facility, it is sometimes also sent through a centrifuge to remove particulates, a process known as clarification, and cooled to 4°C via a heat exchanger on its way to a refrigerated storage tank. Stored raw milk is kept at 4°C prior to processing, usually by way of a jacketed storage tank.

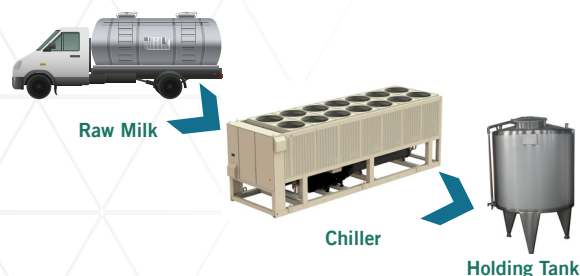
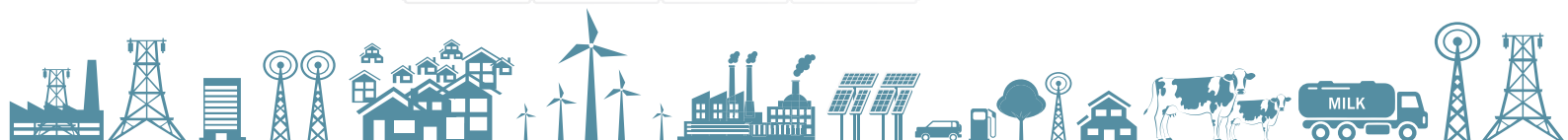

Figure 8: Milk Receiving



Pasteurization, sterilization, and other heat treatments are occasionally done via a batch process, where a tank of the milk is heated to a specific temperature and held for a specific length of time. However, by far the most common method used is a continuous process.

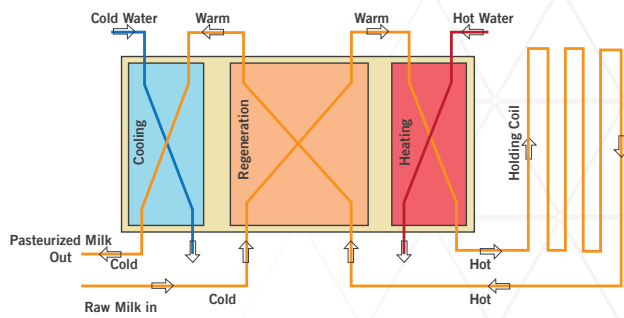

Figure 9: Pasteurization process

In a continuous process, a gear pump or a flow regulator is used to deliver a constant and accurate flow rate to the pasteurization process. The stream is passed through a heat exchanger, which heats the milk to the desired temperature. It is then pumped through a specific length of piping to hold it at this temperature for a specified period of time, and then it is cooled back down. Most dairy processors use a process called

regeneration to cut down on energy costs. Regeneration cools the outlet stream by using it to heat the incoming stream, recovering approximately 85% - 90% of the thermal energy. A small amount of steam or hot water is used to finish heating the inlet stream, and a small amount of cooling is used to finish cooling the outlet stream. This heat treatment process serves to kill all the micro-organisms capable of causing diseases. Time and temperature are important for determination of heat treatment.

Standardization is the process to ensure the proper fat content and Solid Non Fat (SNF) content for the desired finished product. Ensuring the proper fat content can be done in one of two ways. Both processes use a centrifuge to separate the very low-fat content and dense skim portion from the high fat content and less dense cream portion. One process involves analyzing the raw milk's fat content prior to processing and calculating the proportion of fat to remove during centrifugation. The other process involves completely separating raw milk as it is unloaded from the tanker truck and individually storing the two phases. These two streams are then recombined in the proportions required by the specific product as the first step of processing.

The latter method is used primarily by larger operations with diverse products, giving them the flexibility to quickly switch the product being produced without having to retest the milk and recalculate the degree of separation. The figure in the illustration is based on treatment of 100 kg whole milk with 4% fat. The requirement is to produce an optimal amount of 3% standardized milk and surplus cream containing 40% fat.

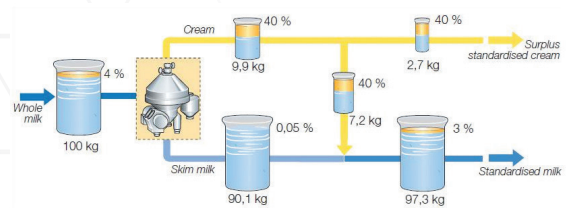
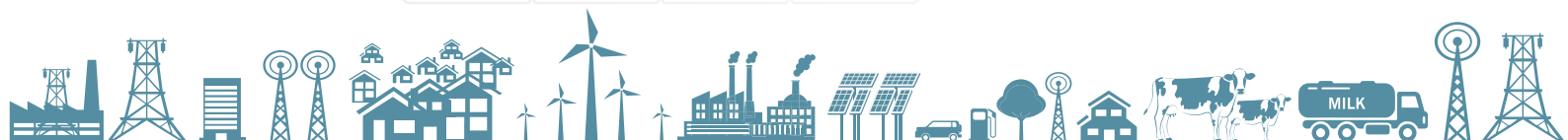

Figure 10: Milk Standardization Process

Separation of 100 kg of whole milk yields 90.35 kg of skim milk with 0.05% fat and 9.65 kg of cream with 40% fat. The amount of 40% cream that must be added to the skim milk is 7.2 kg. This gives a total of 97.55 kg of 3% market milk, leaving $9.65 - 7.2 = 2.45$ kg of a surplus of 40% cream.



Homogenization: Milk is normally homogenized between the regeneration and heating cycles of the pasteurization process. The purpose of homogenization is to break up the fat globules into smaller sizes and disperse them in the water-soluble component, which prevents them from coalescing and forming the separate layer. Milk fat is what gives milk its rich and creamy taste.

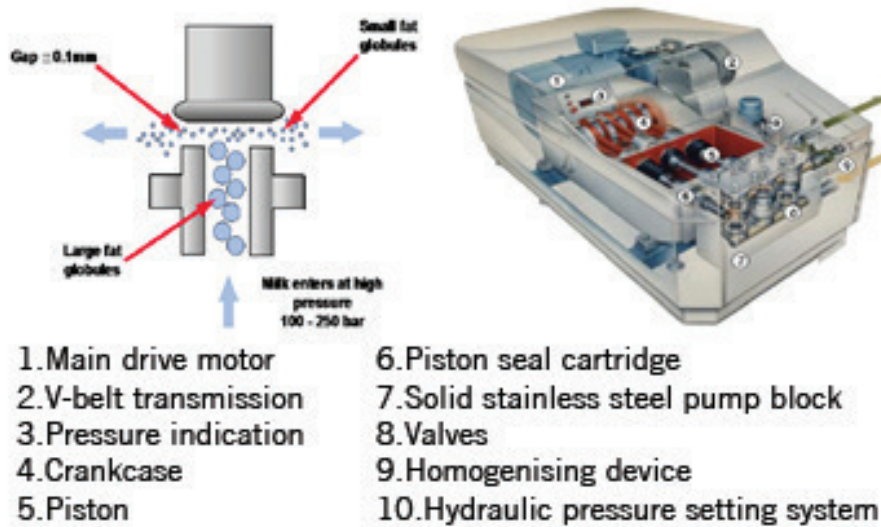

Figure 11: Homogenization Process

Homogenization makes sure that the fat is spread out evenly in the milk. Milk is transferred to an equipment called homogenizer. In this machine, the milk fat is forced, under high pressure, through tiny holes that break the fat cells up into tiny particles, 1/8 their original size. Protein, contained in the milk quickly forms around each particle and this prevents the fat from rejoining. The milk fat cells then stay suspended evenly throughout the milk.

CIP – Clean in Place is a method of cleaning the interior surfaces of pipes, vessels, process equipment, filters and associated fittings, without disassembly. Hygiene is an essential factor in the processing of food products. This requires a good and controlled cleaning or/and sterilization of the processing equipment.

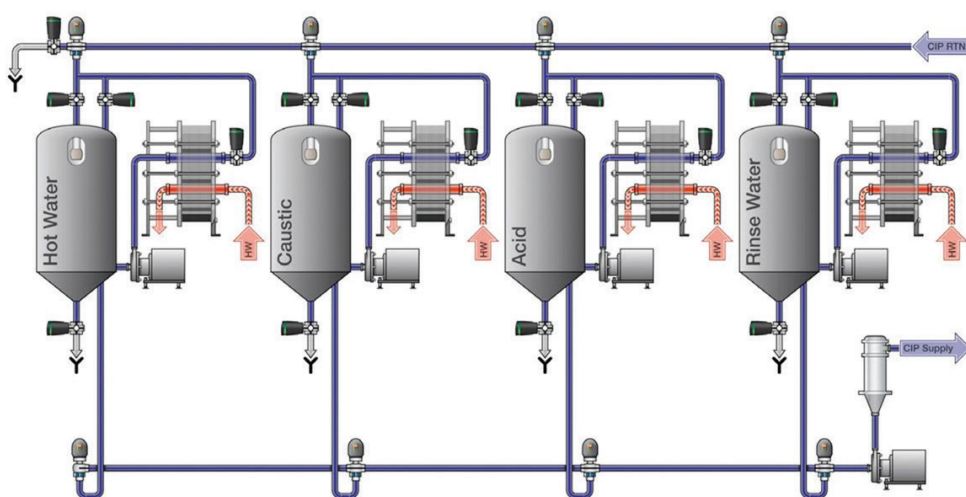
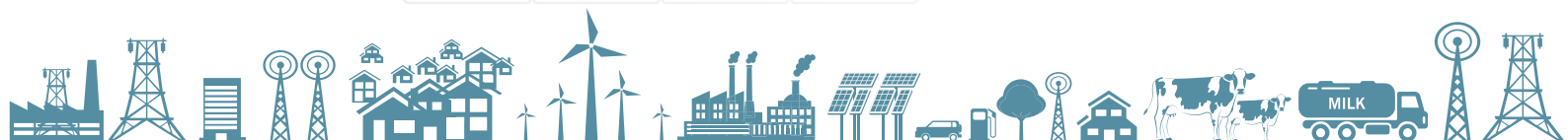

Figure 12: Auto CIP – (Source Alfa Laval)



Packaging and storage: Milk is then pumped through automatic filling machines directly into bags, cartons and jugs. The machines are carefully sanitized, and packages are filled and sealed with automated machines. This keeps outside bacteria out of the milk, which helps keep the milk stay fresh. During the entire time that the milk is at the dairy, it is kept at 1°-2°C. This prevents the development of extra bacteria and keeps the milk fresh.

In addition to the fluid milk, the dairy produces various other value-added products, and unit operations and processes vary from product to product. Depending on the market demand, the dairies produce the value-added product. Some of the value-added products by dairies across India are butter, cheese, buttermilk, ghee, paneer, curd, milk powder, etc.



Figure 13: Milk Packaging

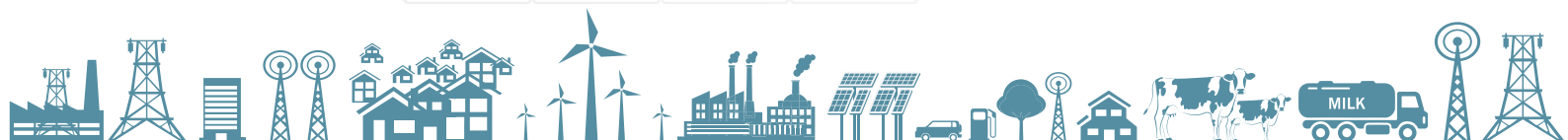
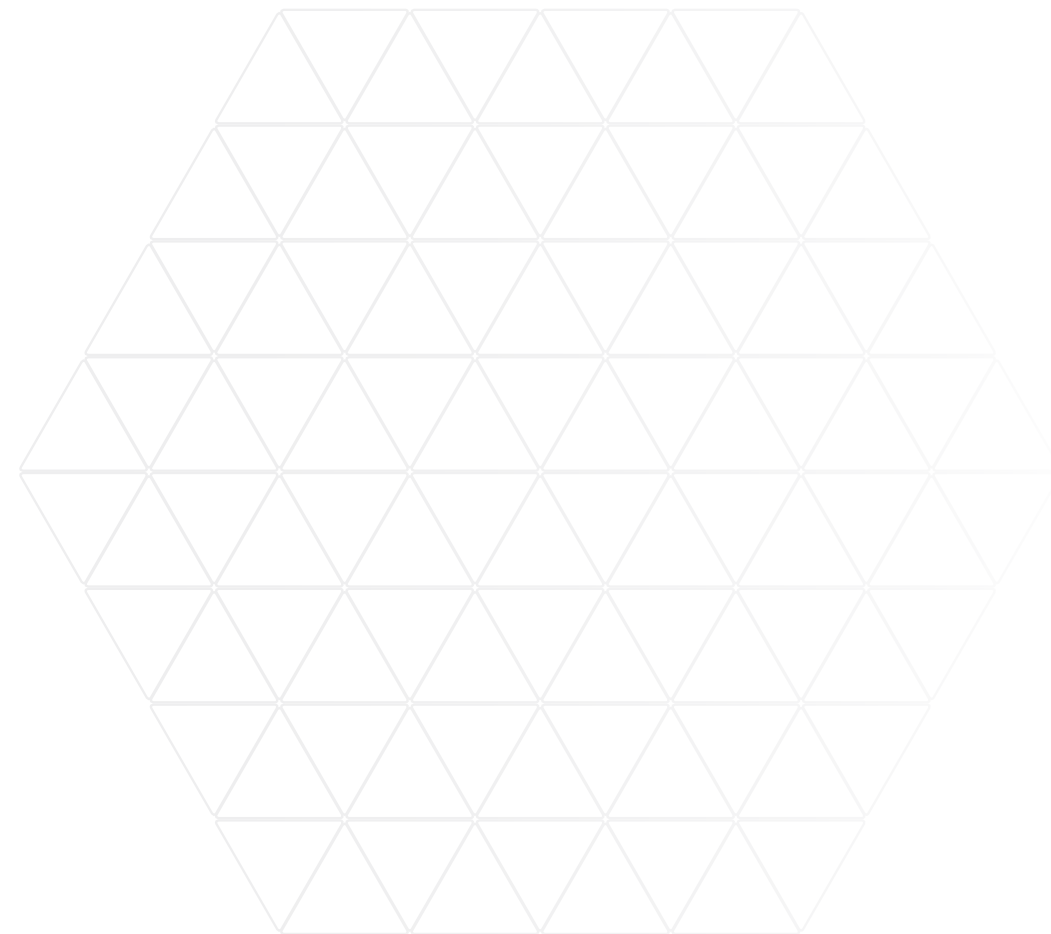

2.3 Energy Consumption in Dairy Plants

The dairy industry uses energy in the form of steam, hot water, and electricity for processing milk and milk products. The cost of energy sources used in the industry is increasing continuously, which in turn increases the processing expenses and, therefore, the product cost. Energy costs typically constitute 10%-20% of the overall manufacturing cost. The following table provides an overview of major energy consuming areas within a dairy plant:

Table 3: Energy Consumption Overview for Dairy Plant

Sr. No	Equipment	Process Requirement	Primary Energy	Secondary Energy
1	Pre Chiller	Cooling	Electricity	Chilling Media
2	Pasteurization	Heating	Natural gas (NG)/Briquette/Furnace oil/High Speed Diesel (HSD)	Steam
		Cooling	Electricity	Chilling Media
3	Cold Rooms	Cooling	Electricity	Chilling Media
4	CIP	Heating	NG/Briquette/FO/HSD	Steam
5	Milk Powder	Heating	Steam	Steam
6	Value Added Products	Heating	NG/Briquette/FO/HSD	Chilling Media
		Cooling	Electricity	Chilling Media

Energy consumption of different processing plants varies widely, depending on capacity utilization, availability of milk, scale of the plant, technology used, level of automation and product mix. The share of primary energy (thermal and electrical) in a typical dairy plant is depicted in Figure 14 and is primarily dominated by electrical energy.

Energy Cost - Share (Dairy Plant)

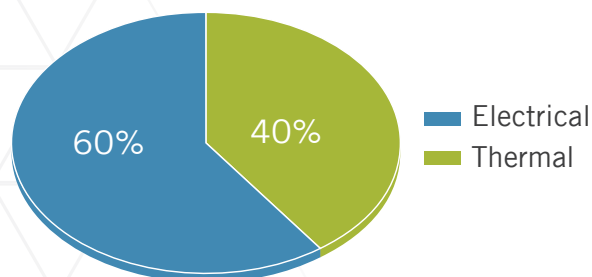

Figure 14: Energy Cost – Breakup (Dairy Plant)

Energy Balance of a Dairy Plant

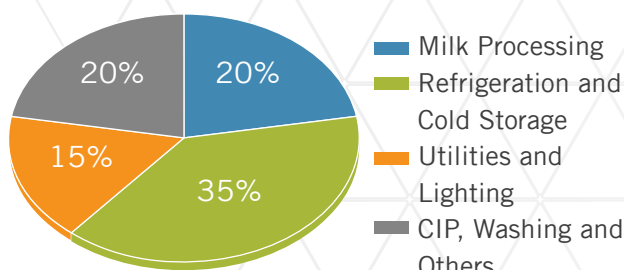
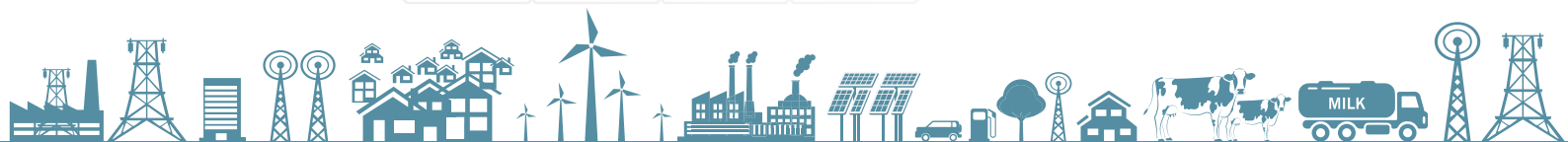

Figure 15: Energy Balance of a Dairy Plant

The major portion of energy consumption in a typical dairy goes to refrigeration, general utility, and services, which include heating and steam generation. A certain portion of energy consumption goes to the cleaning operation and the processing activity. The major energy consuming equipment includes refrigeration system, air compressors, lightings, pumps, motors, homogenizers, evaporating plants, separator and clarifiers,



effluent treatment plant, CIP and boilers. Figure 15 highlights the overall energy balance of a plant. More than 35% of the total energy consumption is consumed in refrigeration and cold storage, and 30% is consumed in milk processing, which includes heating and cooling, while the remaining energy is consumed in other supporting activities such as cleaning, utilities and packing.

Dairy plants in India have seen significant improvement in energy and productivity in the last few years due to increased levels of automation and technology development. This has helped in improving product quality and operating conditions while reducing product losses, maintenance time, manpower requirement and energy consumption. Innovations like cooling of hot cream with chilled raw milk have been adopted to improve regeneration efficiency and, thereby, reduce energy consumption. The new, dairy plants have implemented new energy efficient process equipment like plate heat exchangers, cream separators, homogenizers, etc. Building designs now provide more natural light coupled with a natural ventilation system, which has led to conservation of energy as well as improvements in operating conditions.

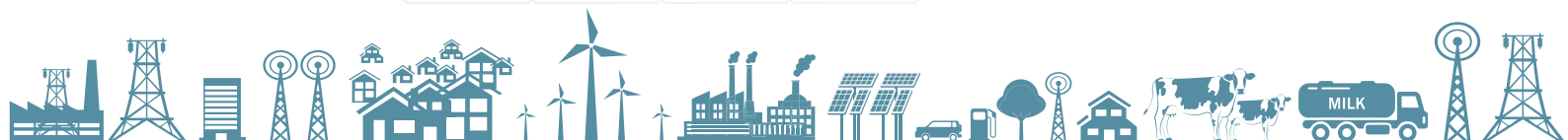

2.4 Technology Status in Madhya Pradesh Dairy Cluster

The dairies in Madhya Pradesh were mostly established during the period of 1980's and have expanded over time with upgradation of equipment and technologies, expansion, automation, and process control. Many of the dairies have also adopted latest technologies in processing and other important areas of the dairy processing plant. Following is the technology status for the dairies in Madhya Pradesh:

Table 4: Technology Status – Madhya Pradesh Dairy Cluster

Sr. No	Area	Current Status
1	Energy Sources	<p>Electrical and thermal energy are the major energy consumed in the dairy plant.</p> <p>Electrical Energy – The dairies procure fuel from distribution companies in Madhya Pradesh and pay in the range of INR 6 /kWh.</p> <p>For thermal energy it is mostly met through solid fuel and liquid fuel. In Madhya Pradesh the dairy procure fuel from supplier is made available for the units to use for their requirement in boilers. Solid Fuel fired boilers are used across various dairies (Coal). In addition to these, High-Speed Diesel is also used in dairy units for meeting their thermal energy requirement.</p>
2	Steam Generation	<p>The dairy units in Madhya Pradesh use boilers for meeting their steam requirement. It is generated in range of 8-10 kg/cm² in the plants and is used in various processes, such as Pasteurizers, CIP and other process areas.</p> <p>Many of the units have incorporated various energy conservation measures such as air preheater, etc. However, not all the units use economizers, and this presents good opportunity for installation of economizers.</p>
3	Steam Distribution	<p>On the steam distribution side, the dairies reduce the pressure of steam through Pressure Reducing Valve (PRV) and send it to various process/section for use. On the condensate recovery, not many units have the systems in place for maximum recovery and this is still a large potential area to be targeted. In addition to that, the steam trap monitoring and maintenance is also an important area for dairies to focus on. However, not all the units use efficiency monitoring systems or waste heat recovery, and this presents good opportunity for upgradation</p>
4	Refrigeration Compressors	<p>The refrigeration system is a critical area for any dairy, as faster and appropriate cooling is a necessity. Many of the dairy units are using reciprocating compressors. There is a potential area for replacing existing compressor with screw. In addition to the technology upgradation, other areas where improvement is possible include: waste heat recovery from compressors, liquid ammonia pumping systems, VFD for compressors, automation etc.</p>
5	Condensers	<p>In Madhya Pradesh cluster, most of the condenser cooling system are atmospheric type. There is a potential area for replacing existing condenser with evaporative condenser.</p>

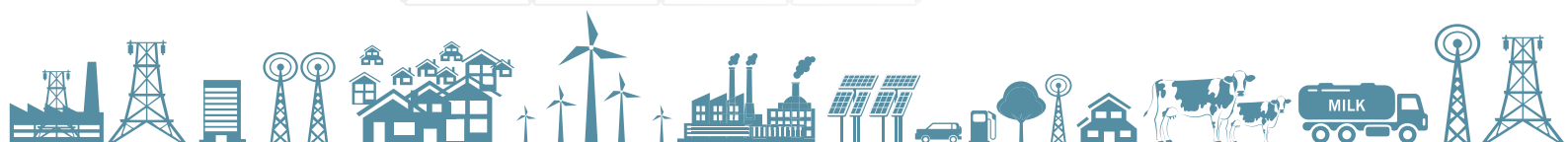

Sr. No	Area	Current Status
6	Process Area	Most of units in the cluster have been using regenerative Pasteurizers for processing, but still there is a good potential exists in the cluster to upgrade the existing regenerative Pasteurizer to high regenerative Pasteurizers. In addition to the above, opportunity still exists in terms of technology upgradation as well as in process automation and control.
7	Renewable Energy	There's good potential for Solar Photo Voltaic (PV) installation in various dairies in Madhya Pradesh.
8	Others	The other equipment and technologies to support dairy processing are Pumping, electrical distribution, compressed air systems, etc.
8a	Pumping	The pumping systems are used extensively in dairy processing for pumping milk and water. The efficiency of these pump sets needs to be evaluated, as some pumps are old and when expansion is undertaken, new pump sets are installed, but often there is good scope for improvement by avoiding throttling (installation of VFD, trimming of impeller) or installation of high efficiency pump sets (more than 60% efficiency).
8b	Electrical Distribution	Power Factor: Most of the units have installed Automatic Power Factor Controller (APFC) for power factor improvement. For harmonics control, the units have also installed harmonic filters. However, there are certain opportunities which dairies can tap in electrical distribution, such as installation of energy efficient transformers, optimal loading of transformers, installation of energy efficient motors, installation of VFD, soft starters, auto star delta conversion, etc.
8c	Compressed Air	Compressed air in dairy units is used as instrument air and in packing machines. Most of the units have converted their old reciprocating compressors to screw air compressors to meet their compressed air requirements.

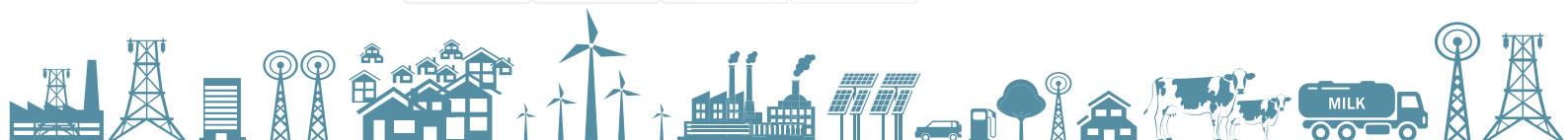
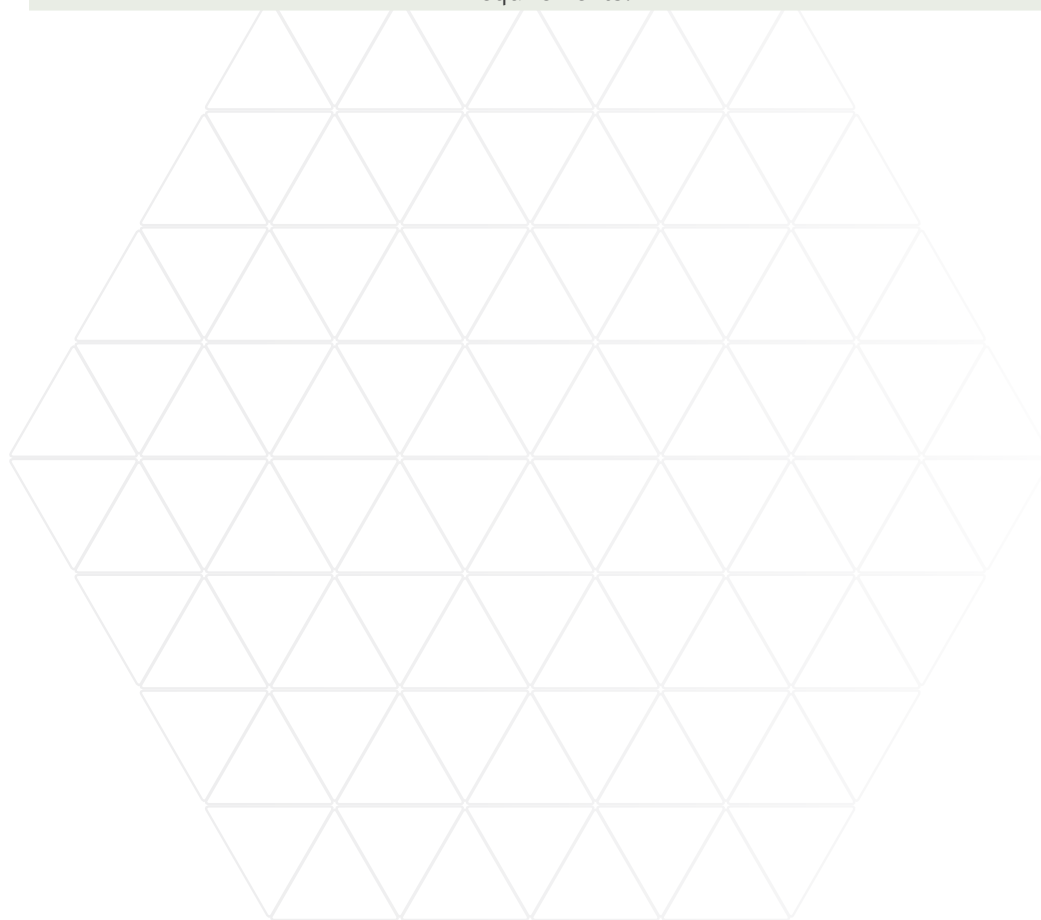

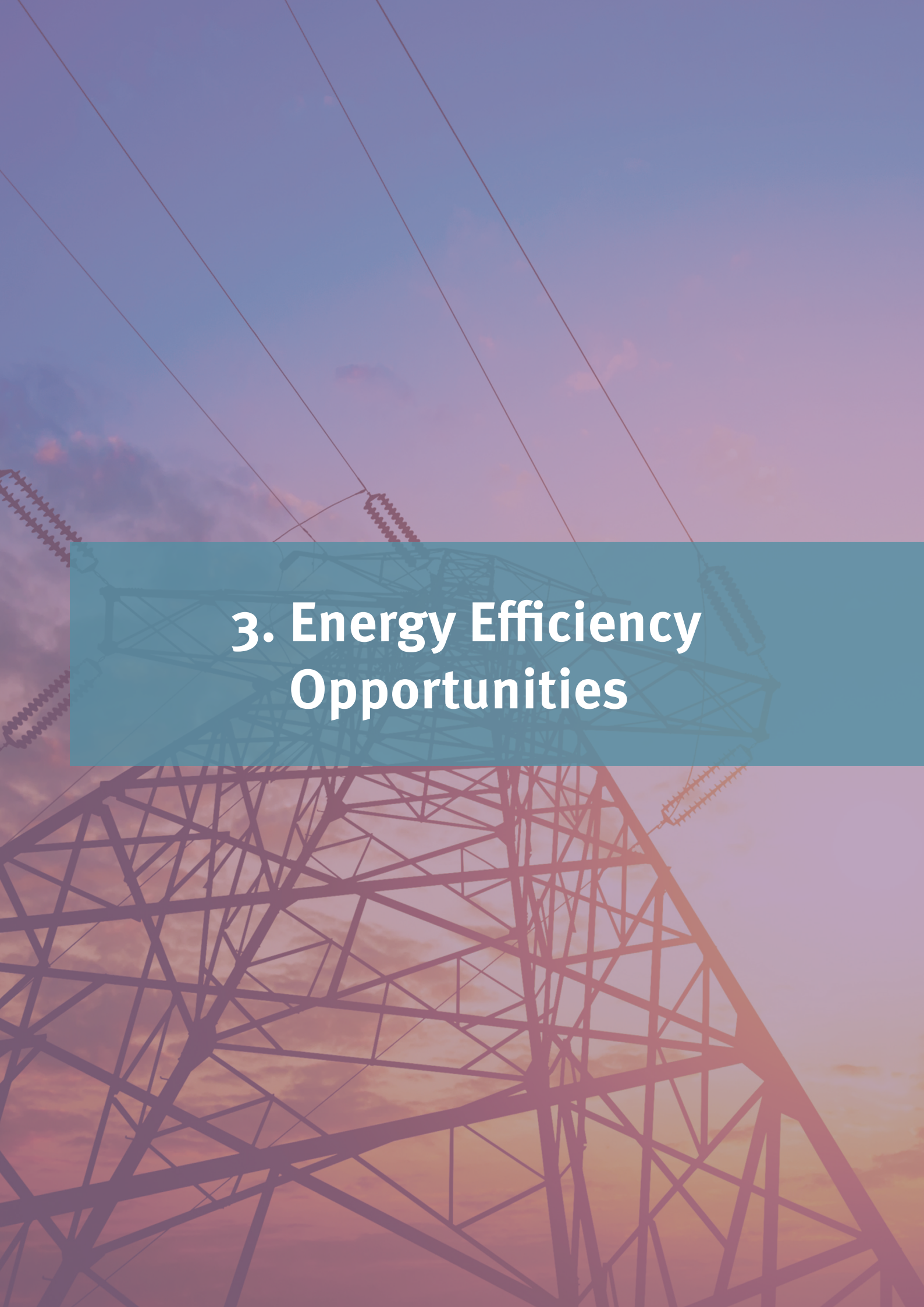

3. Energy Efficiency Opportunities

3. Energy Efficiency Opportunities

3.1 Energy Efficiency in Dairy

The dairy operations are highly energy intensive as the milk and value-added products are to be heated and cooled in various cycles to ensure that they are not spoilt and have a long shelf life. The refrigeration and steam systems are necessary and energy consuming for any dairy and improving energy efficiency in these areas are critical.

Over the years, there has been significant technology improvement in process and utilities area and dairies have been able to improve energy efficiency in their operations. However, opportunities still exist for dairies to improve their energy efficiency and to become more competitive. For environment friendly operation, energy efficiency is indispensable.

The dairies have been implementing various energy conservation measures across various production processes. Energy efficiency at a dairy industry can be viewed at two levels – equipment & component level, and process level. The energy efficiency at equipment or component level can be achieved by adopting various new technologies, preventive maintenance, optimum utilization, or replacement of old equipment with new and energy efficiency equipment. In addition to improving energy efficiency at equipment or component level, the dairy industry in India has made significant improvements in process level efficiency through various energy conservation measures such as automation, process control & optimization, process integration or implementation of new and efficient processes.

Often, energy efficiency measures when implemented at the dairy operations not only result in improvement in energy efficiency but also in productivity and quality. To summarize, the energy efficiency strategy for dairy industry can be focused at three levels:

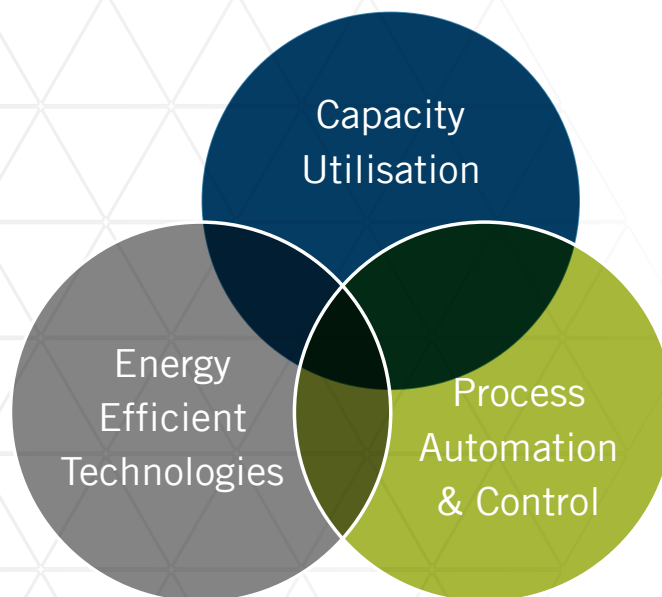
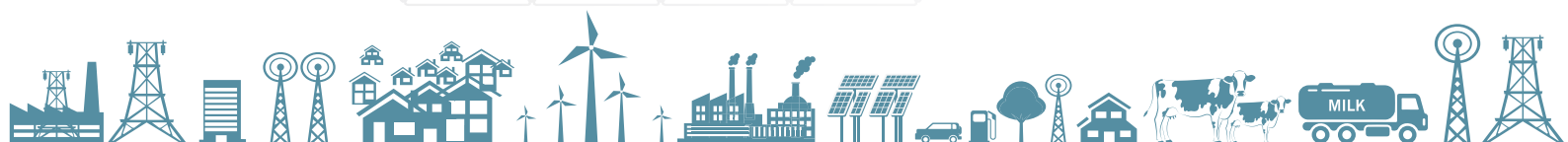

Figure 16: Energy Efficiency Approach – Dairy Industry



3.2 Energy Efficiency Measures

There are various energy consuming areas within a dairy plant which can be classified as primary energy consuming areas, such as steam systems and the refrigeration plant. The following figure provides an overview of energy usage in a dairy plant:

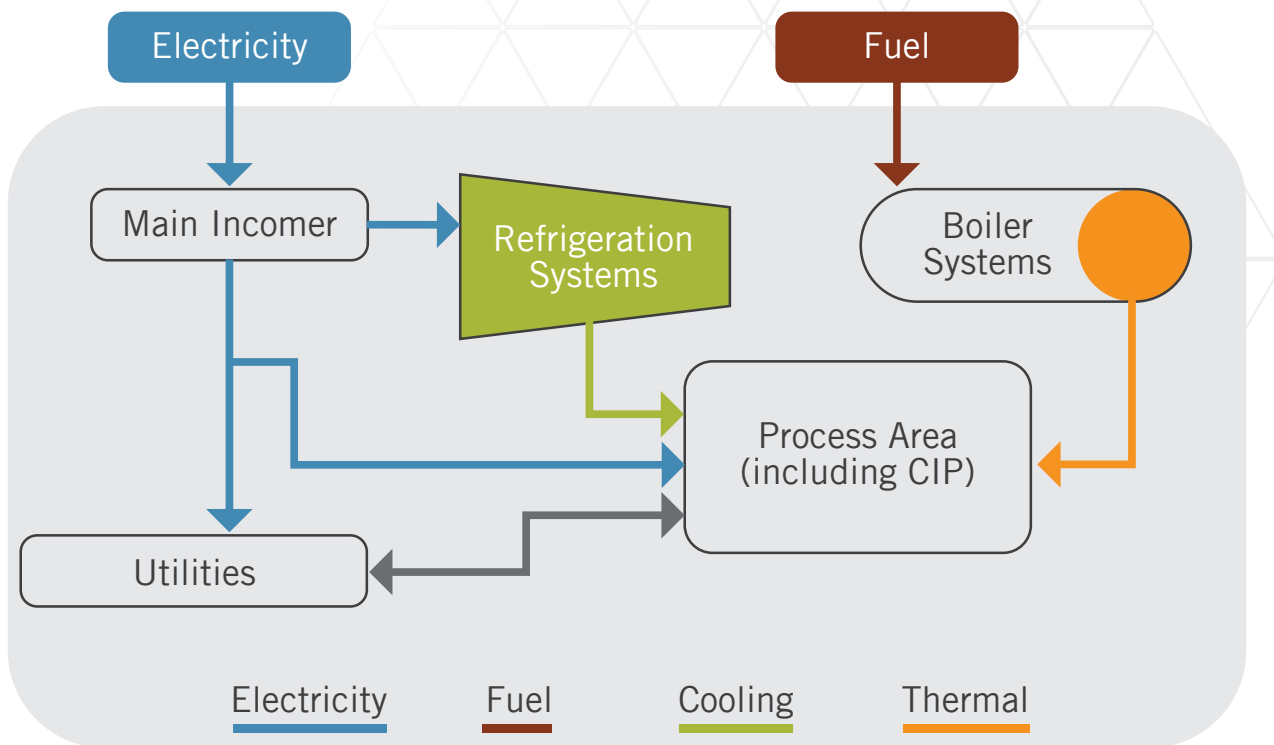
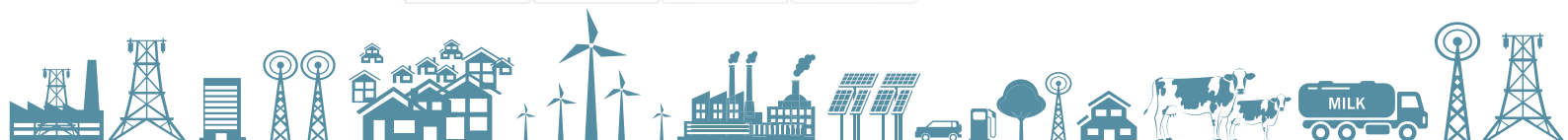

Figure 17: Dairy - Energy Consumption Overview

The following section provides an overview of some of the key energy efficiency measures in major energy consuming areas in a dairy unit. In further sections, some of the latest applicable technologies are covered.



3.2.1 Energy Efficiency in Steam Systems

The steam or steam generation is an important utility area for dairy, as many of the processes in a dairy unit require heating of raw milk or products for various process requirements. The steam is generated in a fuel-fired boiler and is further distributed into process through steam distribution systems. The energy efficiency in steam generation and steam distribution is an important area as it accounts for approximately 25-30% of the energy cost. Following are some of the key energy conservation measures in steam generation and steam distribution systems:

Table 5: Energy Efficiency Measures in Steam Generation and Distribution Systems

Energy Efficiency in Steam Generation and Distribution Systems	
Steam Generation – Boilers	
Use of Energy Efficient Boilers	Fuel Switch (FO to Briquette)
Excess Air Control	Boiler Process Automation, Control & Monitoring
Improved Insulation	VFD for ID Fan
Proper Boiler Maintenance	Automatic Blowdown
Economizer and Air Preheaters	Condensate Recovery
Steam Distribution	
Appropriate Selection of Steam Trap	Improved Insulation
Reduced Pressure drop in pipelines	Steam Trap monitoring and maintenance
Recovery of Condensate	Flash Steam Recovery
Steam Monitoring and addressing steam leaks	Proper Design of Distribution Systems
Management Systems	
Effective monitoring of Key Parameters	Root Cause Analysis

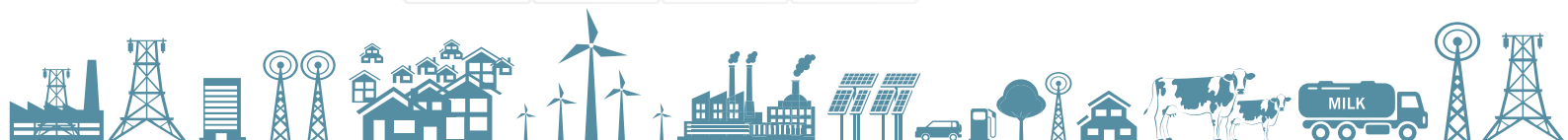

3.2.2 Energy Efficiency in Refrigeration Systems

Refrigeration system is the heart of any dairy value chain. From procurement to consumption of milk, it is stored in low temperatures. For a dairy unit, the refrigeration load can be in the range of 30-40% of the overall electrical load and is hence a significant contributor to overall energy expenses. Thus, energy efficiency at refrigeration can significantly impact the energy consumption and energy cost for a dairy unit. For chilling applications, most dairies use ammonia-based compressors, as they are reliable and efficient for refrigeration effect. The concentrated ammonia is much colder than typical room temperature, which makes it an excellent choice for dairy units. Over the years, there have been many technology developments in the refrigeration systems in compressors, condensers, pump sets, controls, etc. Some of the energy efficiency measures in the refrigeration system are as follows:

Table 6: Energy Efficiency in Refrigeration Systems

Energy Efficiency in Refrigeration Systems	
Compressors	
Use of Screw Compressors	Installation of Variable Frequency Drive (VFD)
Appropriate Refrigeration Charge	Compressor Control and Scheduling
Optimum Suction Pressure	High speed ammonia compressor
Preventive maintenance	Ammonia Overhead feeding systems
Two-Stage Compression	Process Automation & Control
Condensers and Evaporators	
Use of Evaporative Condensers	Preventive maintenance of Condensers
Automatic Tube Cleaning Systems	VFD for Fans
Reducing condensing pressure	Auto Controls
Cycling of evaporators fans	Energy efficient agitators for IBT
Cooling Load Management	
Piping Insulation	Doors/Curtains for Cold Rooms
Minimizing Heat Infiltration	Separation of Cold/Hot Areas
Insulation Paint	Maintenance of Heat Exchangers
Others	
Use of Energy Efficient Motors	Waste Heat Recovery from Compressors
Dedicated compressor for Packing Room Cooling	Chilling Centre Monitoring Systems
Use of Plate Heat Exchangers (PHE) in IBT Cooling	Installation of Falling Film Chiller before IBT
Use of Direct Cooling in IBT	Use of Vapor Absorption Systems

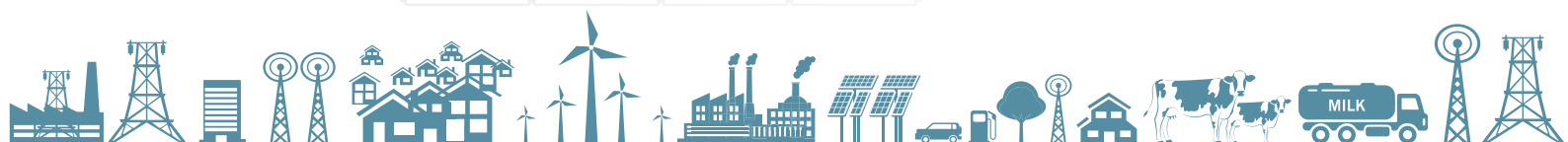

3.2.3 Energy Efficiency in Process

Dairy process for processing milk and value-added products has evolved significantly over time, going from manual production to automatic production. The energy efficiency improvement in process areas will result not only in reduction in demand of utilities (steam, chilling load, etc.) but will also improve productivity and quality. For example, installation of Pasteurizers with high regeneration efficiency can result in reduction in energy demand. Some of the possible energy efficiency measures in process areas in dairy plant are highlighted in the table below:

Table 7: Energy Efficiency in Process Areas

Energy Efficiency in Process Area	
Pasteurization & Homogenization	
High Regeneration Efficiency Pasteurizers	Pasteurizers Hibernation (Tetra Pak, 2019)
Low Temperature Pasteurization	Use of Plate Heat Exchanger instead of Tubular Heat Exchanger
Use of Low Pressure Homogenization (Tetra Pak, 2019)	Partial Homogenization (Tetra Pak, 2019)
Process Optimization	-
Other Measures	
Auto CIP	Heat Pumps Application
Emerging Pasteurization Techniques	Insulation of Hot and Cold Pipes
Reuse first effect condensate	Automation of Pasteurization section
Interlocking of Silo tank fans with level	Use of pre chillers

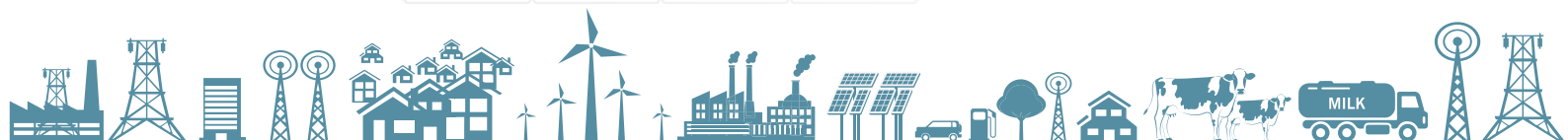

3.2.4 Energy Efficiency in Utilities

The utilities such as compressed air, electrical distribution systems, waste water treatment, lighting and other areas are also energy consuming sections in a dairy plant, and here also many energy efficiency improvement opportunities are available for dairy units. The following table provides an overview of possible energy efficiency opportunities in utilities:

Table 8: Energy Efficiency in Utilities

Energy Efficiency in Utilities	
Compressed Air Systems	
Use of Screw Compressors	Use of Demand Side Controller
Energy Efficient Air Dryers	Auto Drain Valves
Use of VFD	Appropriate Ventilation in Compressor Room
Optimum Generation Pressure	Compressor Leakage (less than 5%)
Pneumatic Equipment to Electric Equipment	Proper distribution systems
Electrical Distribution Systems	
Automatic Power Factor Controller (pf. 1)	Harmonic Filters
Energy Efficient Transformers	Optimum Voltage and line balance
Optimum Loading of Transformers	Energy Monitoring Systems
Pumps	
Energy Efficient Pump Sets	Trimming of Impellers
Maintenance of Pump Sets	Coating for Casing
VFD for Pump Sets	Pumping System Layout
Motors	
Energy Efficient Motors	Star to Delta Conversion
kVAr Compensators	Preventive Maintenance
Optimum Loading	Belt Driven to Direct Coupled
Lighting & Fans	
Use of LED Lights	Use of Brushless Direct Current (BLDC) - Ceiling Fans
Occupancy Sensors	Use of Natural Light (Light Pipe)
Heating Ventilation and Air Conditioning (HVAC)	
Use of Star Rated A	Use of Energy Efficient Air Handling Unit (AHU)
Smart AC Controller	Variable Refrigerant Flow units

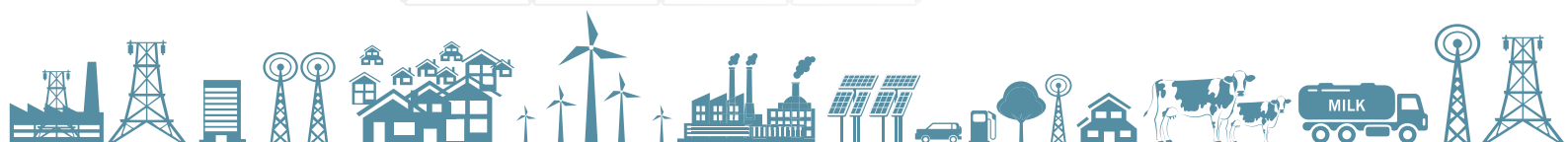

Energy Efficiency in Utilities	
Energy Monitoring and Control	Optimum Cooling at 24°C
Renewable Energy	
Solar PV Installation	Solar Thermal (Evacuated Tube)
Biogas Utilization	Briquette fired boilers
Waste Water Treatment	
Use of Membrane Bioreactor (MBR) System	Biogas Utilization (Piped Natural Gas)
Energy Efficient Pump Sets	Energy Efficient Blowers
Automation and Control	-
Other measures	
Use of Phase change materials	Cogeneration
Trigeneration	Application of Internet of Things (IOT)
Pinch Analysis	-
Water Conservation Measures	
Rainwater Harvesting	Water Efficient fixtures
Reuse of water in gardening	Application of IOT
Energy Management Systems	
Implementation of ISO 50001:2018 – Energy Management Systems	Energy Efficiency Targets and Improvements (Roadmaps)

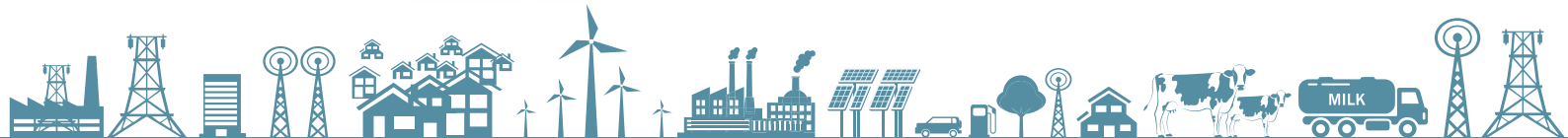

3.2.5 Best Practices and Key Indicators for Energy Efficiency

In addition to the above measures, the dairies can also follow industry best practices, and monitor key performance indicators for ensuring energy efficient operations and processes.

Table 9: Best Practices for Energy Efficient Operations

Sr. No.	Measures	Productivity Impact	Estimated Savings
Steam Generation and Distribution			
1	Generate and transfer steam closer to rated boiler pressure	More output when compared with low pressure steam generation.	3% - 4 % fuel savings
2	Utilize steam at lowest pressure in case of indirect heating	Better heat transfer, less cycle/ heating time, fuel saving and productivity.	For an indirect process requirement with temperature of 80°C, if steam at 3.5 kg/cm ² is used instead of 2 kg/cm ² , the heat loss is in the range of 2% - 3%.
3	Maintain high boiler feed water temperature	Increased boiler efficiency	Increasing feed water temperature by 1 °C results in 1% fuel savings.
4	Maintain Flue Gas Stack exit temperature between as low as possible depending on fuel	Increased life of components in flue gas circuit like duct, fan, and stack. Reduction in downtime and maintenance cost.	Every 22 °C reduction in flue gas exit temperature results in 1% fuel savings.
5	Install Auto Blow Down System	Lower fuel cost due to reduction in makeup water and better boiler efficiency.	Annual savings of 18 Tons of briquette for a 2 TPH boiler operating with continuous manual blowdown.
6	Condensate Recovery from Process	Improves boiler efficiency	10% - 15% fuel savings with 90% condensate recovery.
Refrigeration Systems			
7	Raise the chilled water temperature and reduce condenser water temperature to max possible extent	Optimum cycle time and energy consumption	Raising of chilled water temperature by 0.5°C to 1°C results in 2% - 3% power saving, and if the condenser water temperature is decreased by 2°C to 3°C, the system efficiency can increase by as much as 2% - 3%.
8	Avoid scale formation and fouling in heat exchangers	Optimum cycle time and energy consumption	2% - 3% savings in compressor power
9	Install Variable Frequency Drives (VFDs) for evaporator fans.	None	10% - 15% savings in evaporator fan power consumption
10	Waste Heat Recovery from chiller compressor	None	7% - 8% fuel savings
11	Replacing shell and tube condenser with evaporative condenser	Water savings	50% savings in condenser auxiliary power and 8% - 10% savings in compressor power.
12	Installation of VFD for chiller compressor	None	8% - 10% power savings
13	Installation of Prechiller before IBT	None	20% - 30% savings in compressor power

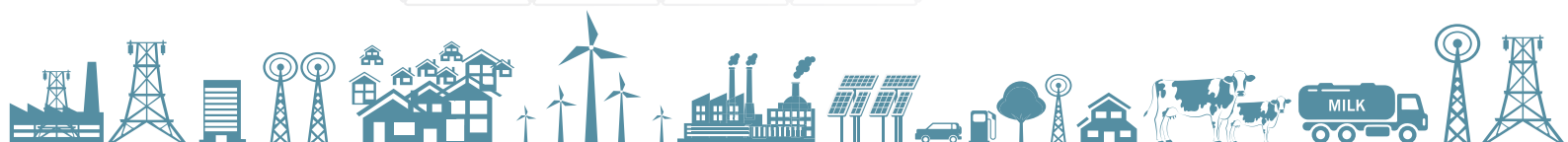

Sr. No.	Measures	Productivity Impact	Estimated Savings
Compressed Air			
14	Arrest air leakages in the compressed air system	Zero down time due to instrumentation fault / low compressed air pressure fault. Target less than 5%	Every 10% reduction in air leakage reduces the electrical energy consumption by 10%.
15	Generate compressed air at the optimum pressure	None	A reduction in the delivery pressure by 1 bar in a compressor would reduce the power consumption by 8%.
16	Replacement of old inefficient compressor with screw compressor	Zero down time due to less maintenance	10% - 15% compressor power savings
17	Installation of VFD in air compressor to avoid unloading	None	15% compressor power savings
Process Area			
18	Process control optimization	High productivity improvement	10% - 12% cost savings
19	Proper monitoring of pasteurization process parameters	Monitoring of key parameters allows proper functional evaluation of Pasteurizer, which helps in upkeep of productivity.	<ul style="list-style-type: none"> ❖ Every 1°C increase of milk temperature after regenerative heating zone reduces steam consumption by 1.9 kg/kl of milk. ❖ Every 1°C reduction of milk temperature after regenerative cooling zone reduces chilling load by 0.33 TR / kl of milk.
Others			
20	Replace low efficiency pumps with energy efficient pumps	Reducing the cycle time for process applications	15% - 25% savings in power
21	Use of VFDs for controlling the pump speed as per process requirement	None	20% - 30% savings in power
22	Improvement of overall power factor of the plant	None	10% - 20% cost savings
23	Installation of light pipe to avoid artificial lights during day time	None	100% savings in power
24	Replacement of Ceiling Fans with Energy Efficient BLDC fans	None	50% power savings
25	Replacing old-rewound motors with energy efficient motors	None	20% - 30% savings in power
26	Energy savers for split ACs	None	20% - 30% savings in power
27	Biogas Generation from ETP	None	2% - 3% energy reduction
28	Solar Thermal System	None	5 kl Solar thermal can result in INR 2.5 lakh saving

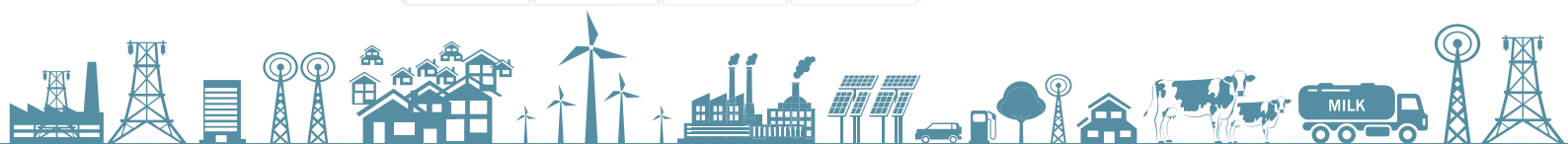

Monitoring of critical parameters of facilities and equipment is essential for ensuring optimal performance of key energy consumers in the dairy. Some of the useful energy indicators which plants can utilize for monitoring their performance are given below:

Table 10: Energy – Key Performance Indicators

Sr. No.	Parameter	Measurement Unit	Indicator
1	Boiler Steam Pressure	kg/cm ²	Nearer to boiler rated pressure
2	Boiler Steam Temperature	°C	Nearer to boiler rated temperature
3	Boiler Water TDS	ppm	3,200 – 3,500 ppm
4	Oxygen in Boiler Flue Gas	%	FO/NG fired – 2.5% – 3% Briquette/Wood fired – 4%
5	Boiler Flue gas temperature	°C	120 - 180 °C for package boilers
6	Steam to Fuel Ratio / Evaporation Ratio		2 - 3.5 for biomass fired boilers 4 - 7 for coal fired boilers 11 - 14 for oil /gas fired boilers
7	Specific Steam consumption at Pasteurization process	kg steam / kl milk	Indirect: 20 - 22 kg /kl Direct: 16 - 19 kg / kl
8	Feed Water temperature	°C	Above 85°C
9	Range of Cooling Tower	°C	9 - 12°C
10	Approach of Cooling Tower	°C	3 - 4°C
11	Refrigeration Compressor Specific Energy Consumption	kW/TR	0.8 - 0.9 kW/TR for Screw Compressors 1.1 - 1.3 kW/TR for Reciprocating Compressors
12	Ice Bank Tank (IBT) & Cold Room Temperature	°C	IBT: 0°C - 0.5°C Cold Room temperature based on product stored
13	Compressed air Generation Pressure	kg/cm ²	Closer to user requirement
14	Compressed air Loading %	%	80 - 90%
15	Compressed air Unloading %	%	10 - 20 %
16	Compressed air SEC	kW/cfm	0.18 kW/cfm for Screw Compressors 0.14 kW/cfm for Reciprocating Compressors
17	Pasteurization Raw milk inlet temperature	°C	4 - 7°C
18	Temperature after pre- heating by Regeneration	°C	9 – 10°C lesser than pasteurization Temperature
19	Pasteurization Temperature	°C	75 - 79°C, depending on holding time
20	Temperature after pre-cooling by Regeneration	°C	15 - 20°C
21	Chilled Milk Temperature	°C	3 – 4°C

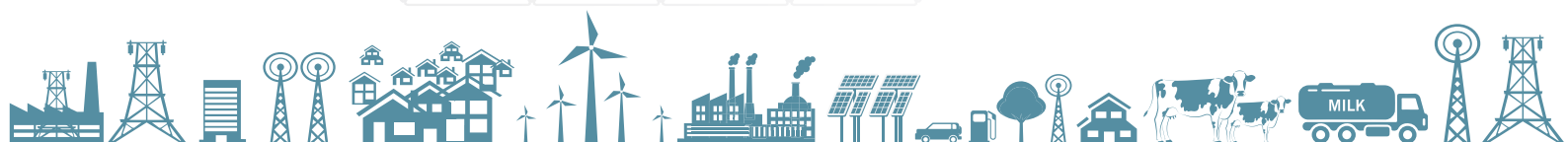

Sr. No.	Parameter	Measurement Unit	Indicator
22	Electrical Parameters for Motors	kW,V, I, A, PF	Voltage +/-5% of rated voltage Within +/-5% of rated current Motor Loading > 80% for better efficiency range
23	Electrical Parameters	kW,V, I, A, PF, Harmonics	Plant LT voltage should be 410 -415V PF closer to unity Transformer loading - 50% -60% VTHD < 8% at 415 V side ITHD < 15% at 415 V side

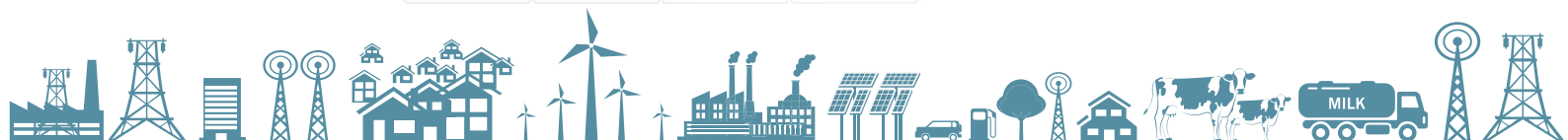
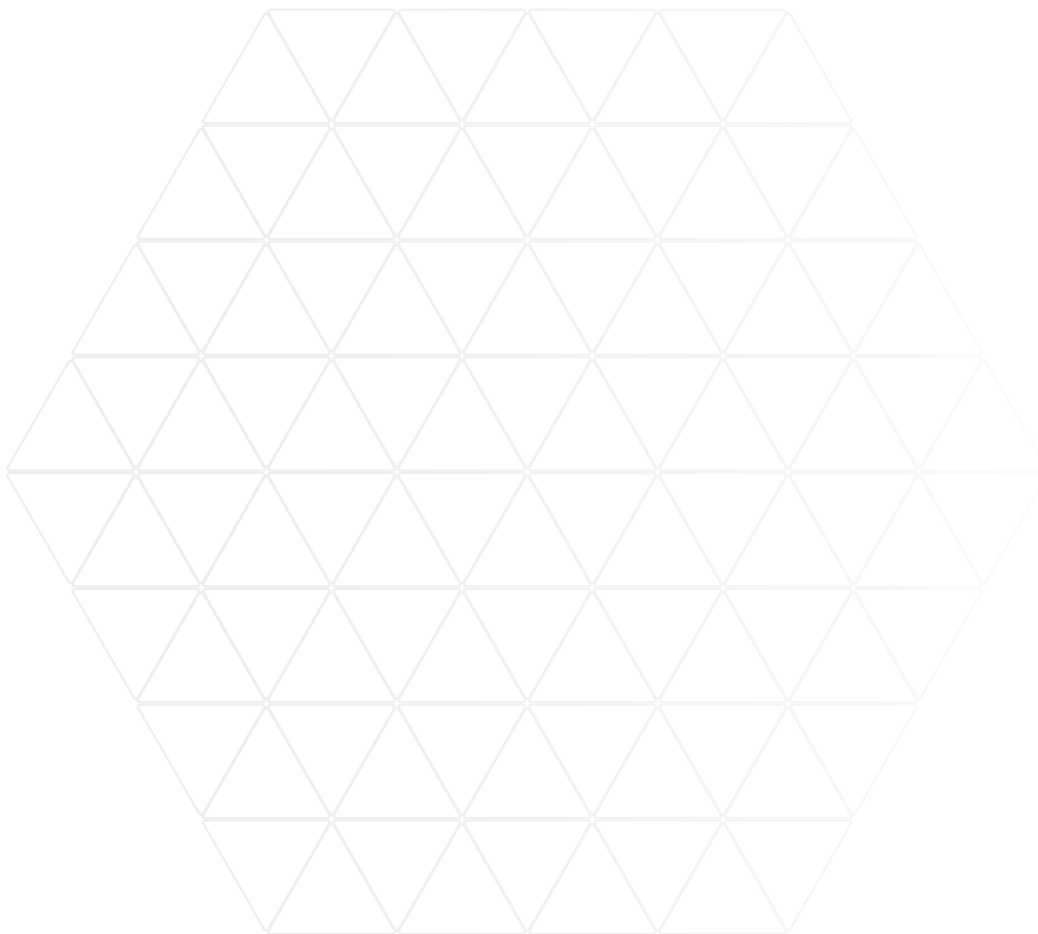

An aerial photograph of a large industrial plant, possibly a refinery or chemical processing facility, with a semi-transparent green overlay. The image shows a complex network of pipes, storage tanks, and structural steel. A large spherical tank is prominent in the upper left. A dark silhouette of a person is visible on a walkway in the upper middle. The overall scene is industrial and technical.

4. Energy Efficient Technologies – Case Studies

4. Energy Efficient Technologies – Case Studies

The energy efficiency measures mentioned in previous chapters are some of the measures implemented in dairy units. The following chapter focuses on some of the above-mentioned technologies which are promising and have been implemented in a few dairies in Madhya Pradesh and have great potential for implementation (Case Study). Over the last few years dairy units in Madhya Pradesh have implemented lot of energy savings measures and these measures have been replicated in most of the other units within the cluster also. These technologies are described in more detail, and wherever possible, a case reference from a dairy that has implemented the technology has been included. In most of the examples, typical energy saving data, Greenhouse Gas (GHG) emission reduction, investments, payback period, etc., have been highlighted. As these case studies are included to provide confidence to dairies to implement technologies, the applicability of these measures may vary from unit to unit, and further technical and financial analysis would be required for individual dairy units. Following case studies are mentioned in detail in the subsequent section:

Table 11: Case Studies for Dairy sector

Sr. No.	Technologies
Steam Generation and Distribution	
1	Conversion of Furnace Oil Fired Boiler to Biomass Fired Boiler
2	Condensate Recovery System
3	Steam Operated Pumping Traps
Refrigeration Systems	
4	Installation of Screw Refrigeration Compressor
5	VFD in Chiller Compressor
6	Replacement of low speed reciprocating compressor with high speed reciprocating chiller
7	Energy Efficient Agitator for IBT
8	Falling Film Chiller
9	Direct Cooling Method - IBT
10	Double effect steam driven vapour absorption chiller heater
11	Desuperheater for Chiller Compressors
12	kVAr Energy Compensator for Chiller Compressor
13	VFD for chilled water pumps
Bulk Milk Coolers	
14	Thermal Energy Storage for BMC
15	BMC Remote Monitoring System

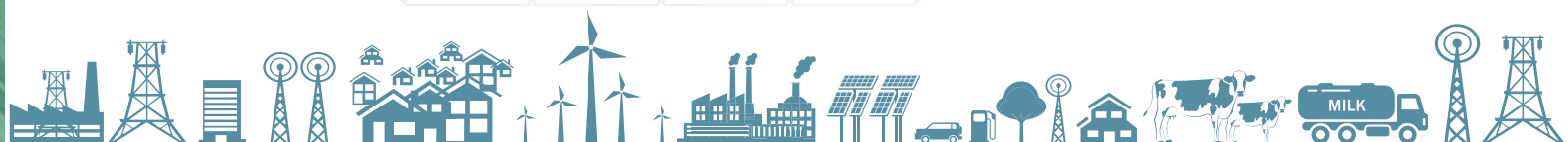

Sr. No.	Technologies
Utility	
16	VFD for Air Compressor
17	Energy Efficient Pumps
18	Package Type Biogas Reactor
19	Methane Capture from dairy effluents
20	IoT based Water Management System
Process	
21	Installation of High Regenerating Efficiency Pasteurizer
22	Preheating of incoming milk in curd Pasteurizer
Renewable Energy	
23	Solar rooftop system
24	Solar Thermal System
25	Solar-Wind Hybrid system

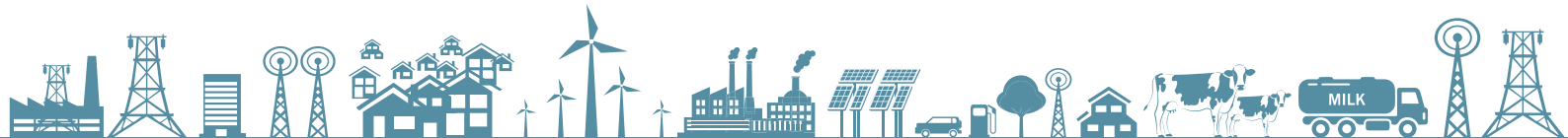
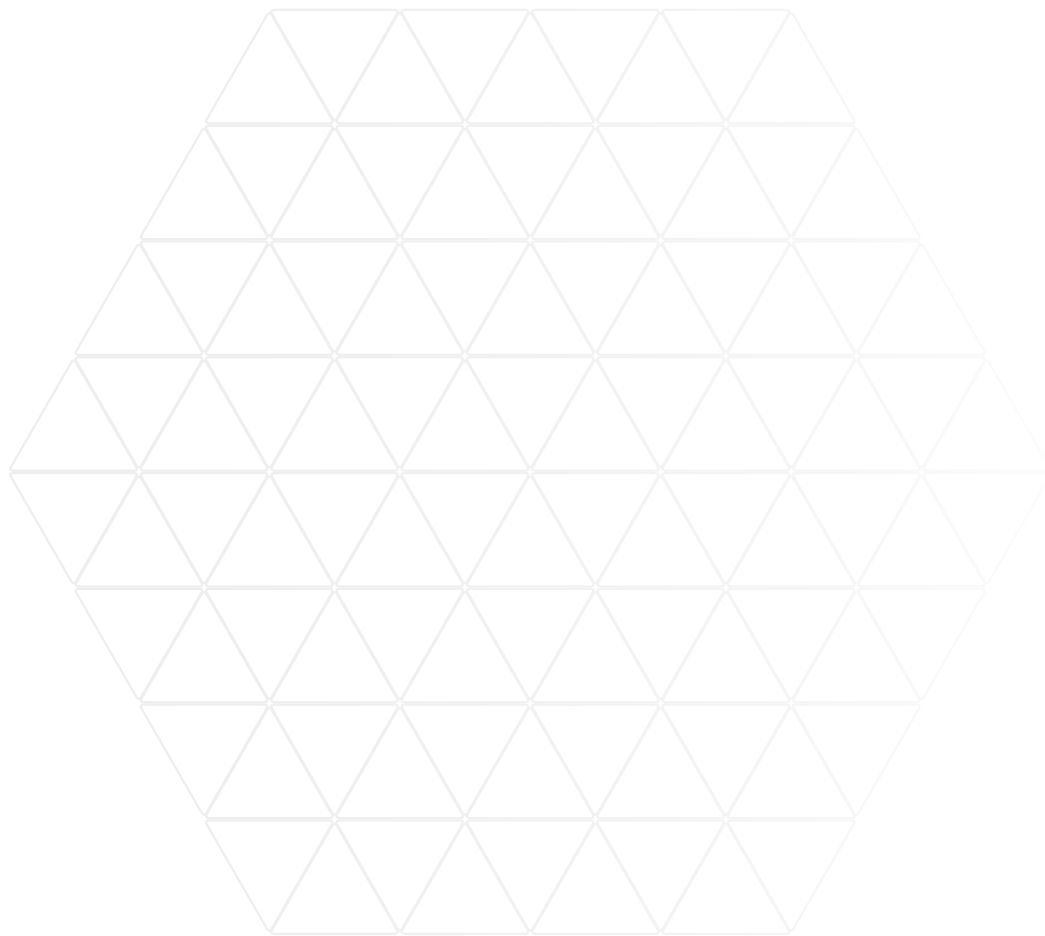

4.1 Case Studies in Steam Generation and Distribution

4.1.1 Conversion of Furnace Oil Fired Boiler to Biomass Fired Boiler

Baseline Scenario

The unit has installed two numbers of 3 TPH FO-fired three pass boilers for steam generation, which is used in process applications such as pasteurization, curd making, CIP, crate washing, etc. The daily furnace oil consumption of one boiler was identified to be at 650 litres/day, with 15 hours working per day. The average steam demand is 450 - 600 kg/hr at 7.5 - 10 kg/cm² g. Normally, temperature levels of process steam of the dairy plant are below 130°C. Steam requirement is about 18-22 kg/kl of Dairy products. The following table shows the steam requirement in the plant:

Table 12: Steam requirement in plant

Sr. No.	Section	Steam Pressure	Steam Flow Rate	Hours of operation per day	Actual Steam Requirement per day (kg/day)
		kg/cm ² g	kg/hr	Hours	kg/day
1	Pasteurizer – 10 kl/hour	8	250	10	2,500
2	CIP 1 - 10 kl	3.5	900	0.33	300
3	CIP 2 - 10 kl	3.5	900	0.33	300
4	Curd Pasteurizer - 2 kl/hour	3.5	75	3	225
5	Product – Cup Curd - 400 litre	3.5	55	3	165
6	Ghee – 1,000 litre	3.5	180	9	1,620
7	Peda Vat 1 - 500 litre	3.5	70	9	630
8	Peda Vat 1 - 500 litre	3.5	70	9	630
9	Paneer Vat – 1,000 litre	8	100	1.5	150
10	Butter Vat – 1,000 litre	8	100	1.5	150
11	Autoclave – 1,200 bottles	8	150	3	450
Total steam requirement					7,120 kg/day

The average steam generation per day is 0.7 tons with an average consumption of 420 to 600 kg/hr. The peak steam requirement in plant is 1,200 kg/hr, when all processes are in operation. The boiler and fuel parameters are shown below:

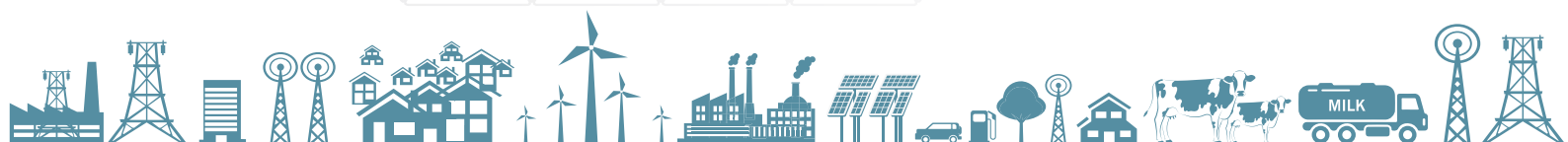

Table 13: Boiler and Fuel Parameters

Parameter		
Boiler Type	Fire Tube, FO Fired, Shell Type	Fire Tube, FO Fired, Shell Type
Boiler Capacity	2 TPH	2 TPH
Boiler Design Pressure	10.5 kg/cm ² g	10.5 kg/cm ² g
Boiler Operating Pressure	7.5 – 9.5 kg/cm ² g	
Average Operating Hours	15 hours per day (2 shifts/ day)	
Fuel		
Fuel Type	Furnace Oil	
Fuel GCV	39,580 kJ/kg	
Fuel Firing Process	Auto	
Cost of Fuel	INR 33/- per kg	
Average Fuel Consumption	650 litres per day	
Number of working days	365 days per year	
Annual Fuel Bill	INR 78.3 lakh	

Past record shows that the average fuel consumption is 650 litres/day for 15 hrs/day of operation. The boiler efficiency was also calculated using direct method, as shown below:

Table 14: Boiler Efficiency

Boiler Efficiency Direct Method		
Feed Water Temperature	35	°C
Calorific value of fuel	39,580	kJ/kg
Steam Flow	475	kg/hr
Fuel Firing Rate	41.98	kg/hr
Enthalpy of steam at 8 kg/cm ²	2,769	kJ/kg
Feed Water Enthalpy at 35 °C	146	kJ/kg
Boiler Efficiency	75	%

Proposed System

An efficient replacement for the current oil-fired boiler will assist in cutting down the increasing production cost. As far as the dairy plant is concerned, their objective is to go towards greener production and with minimal production cost. A sustainable fuel to generate heat for the process should be seen as a sustainable development opportunity. It is therefore highly

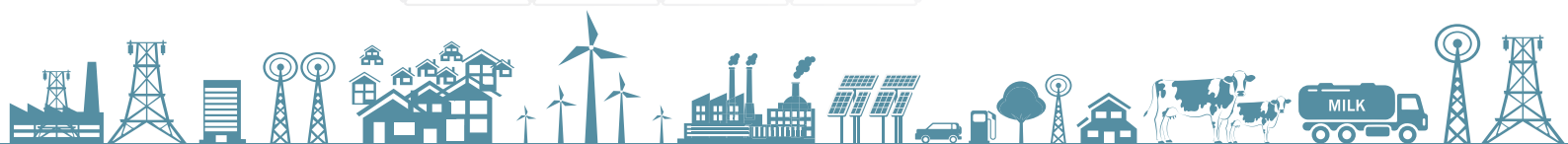

recommended to install a new boiler in the plant with an alternative sustainable fuel like wood or briquette.

Furnace oil used in Boiler can be totally substituted by Wood or Briquette with an equivalent ratio of 2.7:1 kg/litre on the basis of calorific value. This usually results in saving of more than 60% in operating cost, and will have attractive payback period.

Pre-requisite of the boiler substitution:

Availability of good quality new fuel (wood / briquette)

The availability of good quality and continuous supply of fuel is very important. To be feasible for this project, it is suggested that the boundary of the fuel supply distance should have less than a 30 km radius circle. In case of sudden unavailability of fuel, there should be another fuel option.

Availability of sufficient space for new boiler installation

Another factor is the availability of sufficient area. The required space for the boiler and the fuel storage has to be checked with the supplier, and the plant has to make necessary arrangement for the same. It is highly recommended to install new generation biomass fired boiler with automation which works on the principle of continuous monitoring and controlling. Briquette has GCV up to 18828 kJ/kg; 3.2 kg of Briquette is equivalent to 1 litre of furnace oil. At INR 33/litre FO price and Briquette at INR 7.5/kg, the substitution will result in savings of INR 9/litre of FO fired. Similarly, about 5 kg of Wood (30% moisture) of GCV 12252 kJ/kg is equivalent to 1 litre of furnace oil. The savings in this case will be of INR 12.00/litre of FO fired with wood at INR 3.0/kg.

Merits

- ❖ Automation results in feeding optimum amount of fuel to boiler, and thus reduces unburnt loses.
- ❖ Ensures max possible feed water inlet temperature, so that the generation will be maximum possible.
- ❖ Better water quality.
- ❖ Ensures periodic maintenance of boiler tubes, hence reduction in radiation loss.
- ❖ Zero emissions.

Limitations

- ❖ It is suggested that the boundary of the fuel supply distance should be less than a 30 km radius circle.
- ❖ Estimation of proper back pressure.
- ❖ Availability of sufficient space for new boiler installation.
- ❖ Storage area for fuel to keep it dry and away from moisture attack.

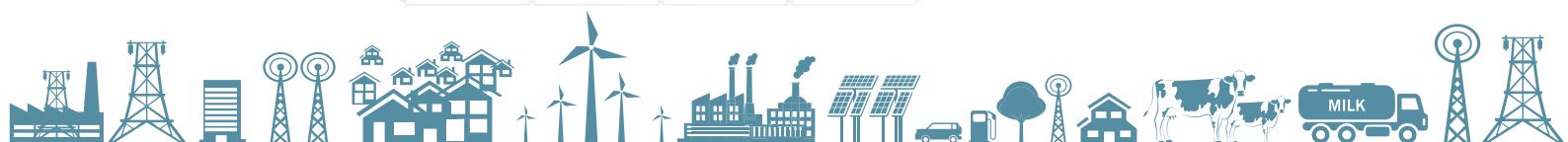

Cost Benefit Analysis

The expected fuel savings to be achieved by installation of fully automated biomass fired boiler is 2,18,363 litres of FO annually. The annual monetary saving for this project is **INR 36.79 lakh, with an investment of INR 60 lakh, and a payback period of 20 months.**

Table 15: Cost Benefit Analysis – Energy Efficient Boiler

Sr. No.	Description	Unit	FO	Wood
	Average steam consumption	kg/hr	433	433
	Steam Enthalpy at 10 Kg/cm ² g pressure	kJ/kg	2,794	2,794
	Boiler Efficiency	%	75	75
	Fuel Calorific Value	kJ/kg	40,375	12,552
	Fuel Consumption	kg/hr	40	129
	Fuel Cost	INR/kg	33	3
A	Cost of fuel per hour	INR/hr	1,319	386
	Ash generated (Total)	kg	0	12
	Rate of Ash Disposal	INR/kg	0.2	0.2
B	Cost of Ash Disposal per hour	INR/hr	0	2.4
	Power Consumption for Utilities	kW	14	19
	Rate of Power	INR/kWh	6	6
C	Cost of Power Consumption per hour	INR/hr	84	114
	Labour for fuel feed per hour	Nos	0	2
	Manual-hour rate of labour	INR/hr	75	75
D	Cost of Labour per hour	INR/hr	0	150
E	Total Running Cost per hour (A+B+C+D)	INR/hr	1,403	652
	Annual hours of operation	hrs	5,475	5,475
F	Total Running Cost per annum	INR lakh	83.8	39.4
	Average Annual Maintenance Cost	INR lakh	2	5
G	Total Operational Cost per annum	INR lakh	76.4	39.6
H	Total Saving per annum with Solid fuel	INR lakh		36.8
I	IRR	%	32.23	
J	Net Present Value (NPV) at 70 % Debt (12% rate)	INR lakh	78.81	

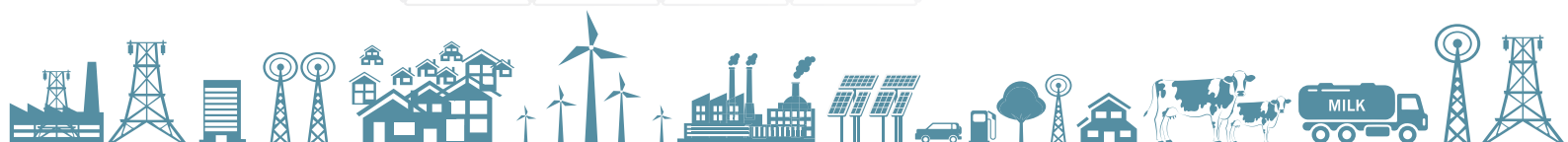

Energy & GHG Savings



Vendor details

Table 16: Vendor details – Energy Efficient Boiler

Equipment Detail	Energy Efficient Boiler
Supplier 1	
Supplier Name	Forbes Marshall
Address	Forbes Marshall, II / 147 A, Nereveetil Building, Thurutheparambu Road, Vazhakkala, Thrikkakkara P.O., Kochi
Contact Person	Mr. Dileep Cherian
Mail Id	cochin@forbesmarshall.com
Phone No	9995752525 / 9744133211
Supplier 2	
Supplier Name	Thermax Pvt Ltd
Address	PLOT NO. 21/1, 21/2 & 21/3, SAVLI INDUSTRIAL ESTATE, Vadodara, Gujarat
Contact Person	Mr. Sanskar Jayaswal
Mail Id	sanskar.jayaswal@thermaxglobal.com
Phone No	+91 9739811416

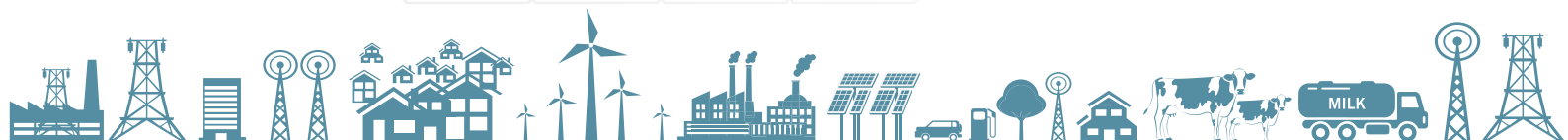

Reference Plant Implementation

Table 17: Reference implementation: Briquette fired boiler

Project Name	Implementation of Briquette fired boiler
Objective	Fuel switch from FO to Briquette fired boiler
Unit profile	Palakkad dairy has an average daily procurement of raw milk-6 Lakh L with an average daily sale of processed milk-5 Lakh Litres Other products- Curd, Ghee, Peda, Butter, Butter milk, Ice cream, Palada, Burfi etc.
Implemented year	2012
Installation Photo	
Assumptions Made	❖ Fuel/Electricity Cost – INR 35/kg ❖ GCV of fuel –40,166 kJ/kg
Savings (INR lakh)	₹ 268.00
Investment (INR lakh)	₹ 315
Simple Payback Period	15 months
Replication potential	Replicated in all dairies where FO is used as fuel
Outcomes	❖ 14,74,312 kg of FO saved annually ❖ Reduction in CO ₂ emission
Unit contact details	Mr. Nirish Dairy Manager Palakkad Dairy, MRCMPU Region Mail Id :pkddairy@malabarmilma.coop Phone No: 0491 2533682
Cluster Reference	Madhya Pradesh

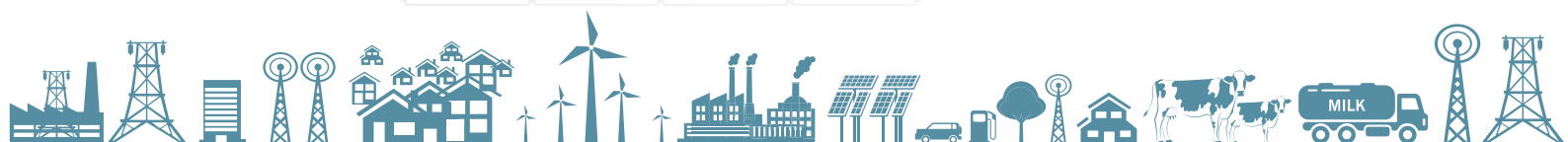

4.1.2 Condensate Recovery System

Baseline Scenario

The unit has installed one 3 TPH briquette-fired boiler and two FO-fired boilers for the process applications, such as pasteurization, curd making, CIP, crate washing, etc. Briquette-fired boiler is running, and the others are on standby. The heating process in dairy is done by indirect heating. One of the major applications of steam is pasteurization process, where the milk is heated to 72°C for 16 seconds, and quickly cooled to 4°C. This process slows spoilage caused by microbial growth in the food. Hot water at around 70°C to 80°C is used for indirect heating in the pasteurization process. The condensate after the process heating is currently drained or used in cleaning crates. As the condensate has some heat available, it can be utilized in the boiler or any other indirect heating for processes such as CIP, crate washing, etc. It was also observed that since most of the condensate drains are left open to atmosphere, it results in flashing of steam, which is a wastage of energy.

Proposed System

Condensate recovery is a process to reuse the water and sensible heat contained in the discharged condensate. Recovering condensate instead of draining it can lead to significant savings of energy, chemical treatment and make-up water. Install a flash vessel and condensate transfer/ pumping unit to recover all the condensate from various processes. Condensate pumping/ transfer system can pump a huge quantity of condensate, effectively utilizing steam, known as motive steam. Condensate is one of the purest forms of water having low electrical conductivity of only 5 $\mu\text{S}/\text{cm}$ or TDS value of 3.5 ppm.

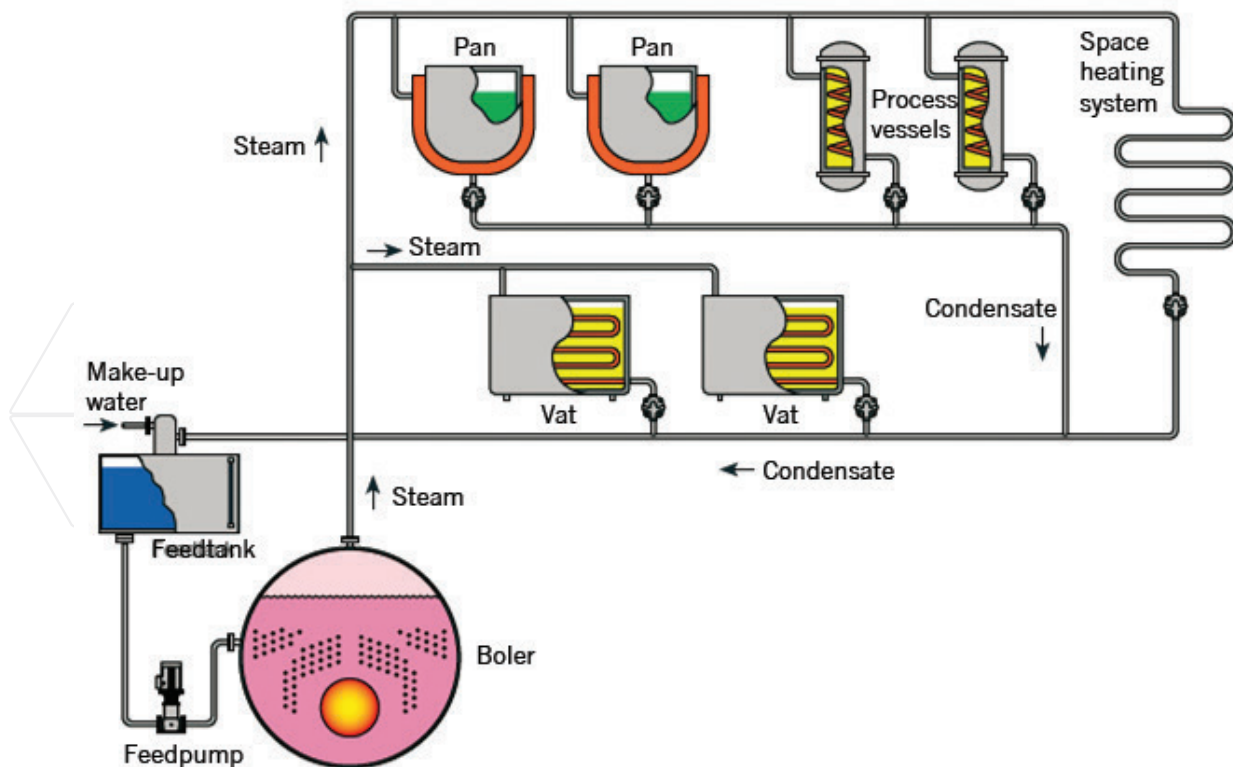

Figure 18: Typical condensate recovery system

Condensate flows from receiver of the pump to the pump body, and the level of water starts increasing and reaches the high level. This is sensed by the conductivity-based level sensor, which activates the motive steam inlet valve. Steam enters the pump at high pressure and the pressure in the pump body keeps on building till it overcomes the back pressure of the delivery side. Now, the outlet check valve opens and the condensate starts flowing out of the pump body, using high pressure of the steam. As soon as the level in the pump reaches the low-level position, the inlet valve for the motive steam is de-activated, and the pump is de-pressurized. The pump again starts filling and the cycle repeats. The system requires no electric motor for operation. As the quantity of condensate discharged at each stroke is known, the total volume passed during a given period can be calculated by counting the number of strokes during the period. Such a counter is provided, enabling display of the total condensate pumped. The totalized volume of condensate pumped is displayed on an electronic unit.

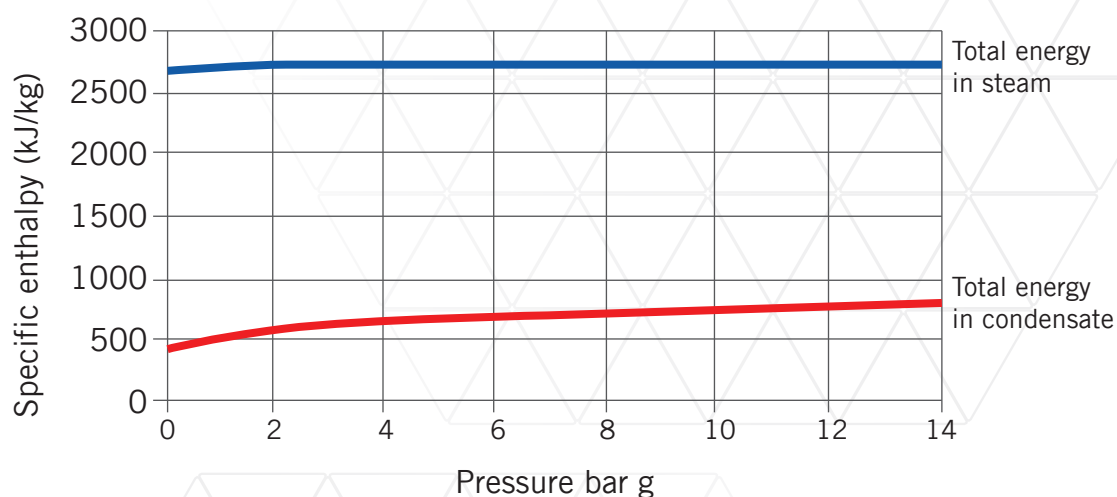
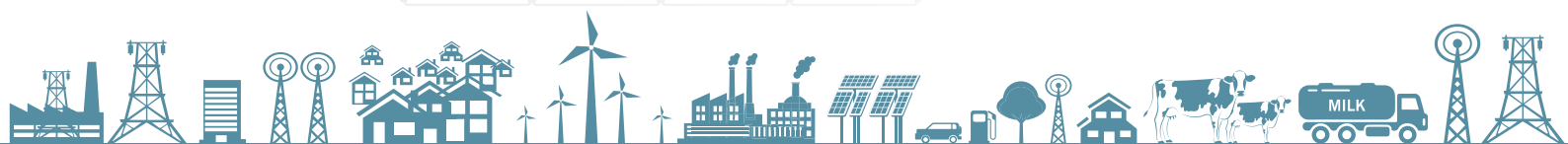

Figure 19: Heat content in condensate

A flash steam generator can be installed for recovery of flash steam just before the condensate recovery system. When high pressure condensate is discharged from steam traps to low pressure condensate return lines, excess energy is released in the form of flash steam. This flash steam can be used to heat boiler feed water or for low pressure steam application.

Merits

- ❖ High availability due to zero moving parts.
 - ❖ High reliability and equipment availability.
 - ❖ Low wear & tear.
 - ❖ Low maintenance.
 - ❖ Low downtime.
- ❖ High motive inlet pressure; no need of pressure reducing valve/ station till 10 kg/cm², where low pressure steam is not available, hence saving on installation cost.
- ❖ High discharge of condensate: 50 litres per stroke.
- ❖ High condensate temperature return: No cavitation issues over electrical pumps.



- ❖ Conductivity-based level controller (a stringent quality & design process followed in European market, to ensure safe operation).
- ❖ A large LED display with flow totalizer to display the total volume displaced.
- ❖ Suitable for outdoor installations.
- ❖ Energy efficient pump; steam trap drain and pump vent taken back to the receiver tank to minimize vent losses.
- ❖ Electrical motor required.

Limitations

- ❖ Requires regular maintenance.
- ❖ Estimation of proper back pressure.
- ❖ Inventory of electronic spare parts to be maintained.

Cost Benefit Analysis

The expected fuel savings to be achieved by installation of condensate recovery system is 1.1 tons of Briquette, annually. The annual monetary saving for this project is **IINR 7.41 lakh, with an investment of INR 6.40 lakh, and a payback period of 10 months.**

Table 18: Cost Benefit Analysis – Condensate Recovery Systems

Parameters	UOM	
Boiler Capacity	TPH	3
Operating Pressure	kg/cm ²	9
GCV	kJ/kg	16,736
Fuel Cost	INR/kg	6.6
Fuel Consumption	kg/hr	209
Boiler Efficiency	%	75
Enthalpy of steam at 9 Bar	kJ/kg	2,773
Steam Flow	kg/hr	1,024.00
Condensate Available considering losses	kg/hr	900
Condensate Working Pressure	kg/cm ²	1.5
Flash Steam	%	5.19
Mass of Flash Steam	kg/hr	46
Mass of Condensate Available	kg/hr	853.33
Latent Heat of flash steam	kJ/kg	2,107.5

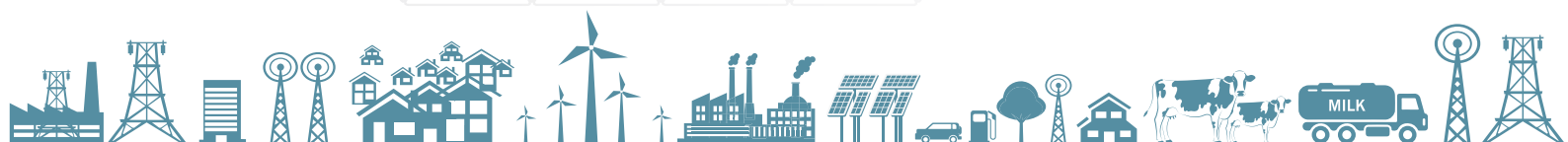

Parameters	UOM	
Fuel saved from condensate recovery	kg/hr	11
Fuel saved from flash steam recovery	kg/hr	7
Total Fuel Saved	kg/hr	18
Operating Hours	hours	17
Operating Days	days/year	360.00
Annual Fuel Savings	kg	1,12,348.24
Monetary Savings	INR lakh	7.41
Investment	INR lakh	6.40
Payback	months	10
IRR	%	143.60
NPV at 70% debt (12% rate)	INR lakh	34.64

Energy & GHG Savings

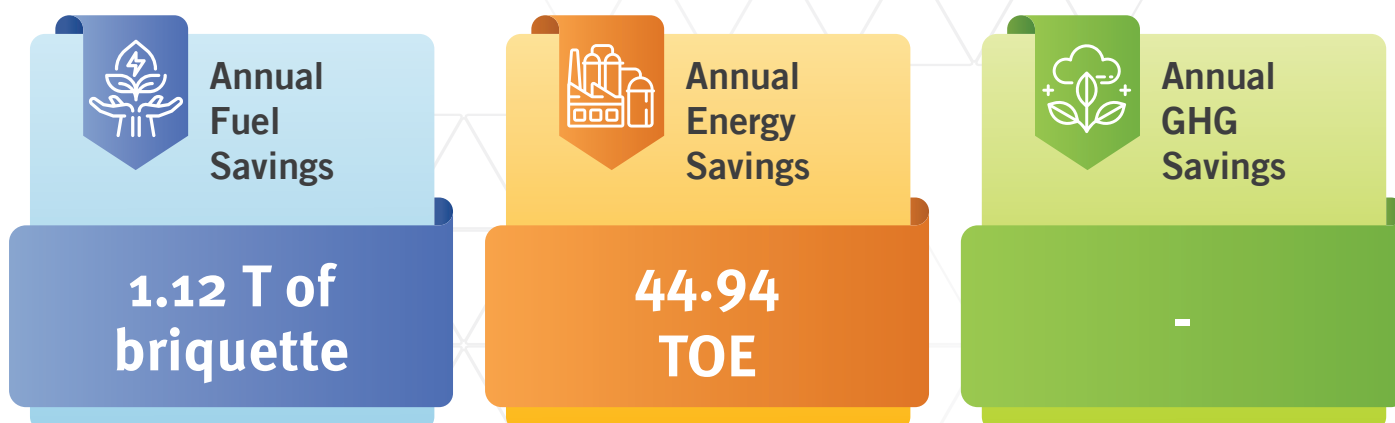

Reference Plant Implementation

Table 19: Reference Implementation – Condensate Recovery Systems

Project Name	Installation of Condensate Recovery System
Objective	Recovery of steam condensate from 12 Peda/Palada VATs at Wayanad dairy and Central Products Dairy
Unit profile	CPD Kozhikode dairy has an average daily procurement of raw milk-6 Lakh Litres and average daily sale of processed milk-5 Lakh Litres Other products- Curd, Ghee, Peda, Butter, Butter milk, Ice cream, Palada, Burfi etc.

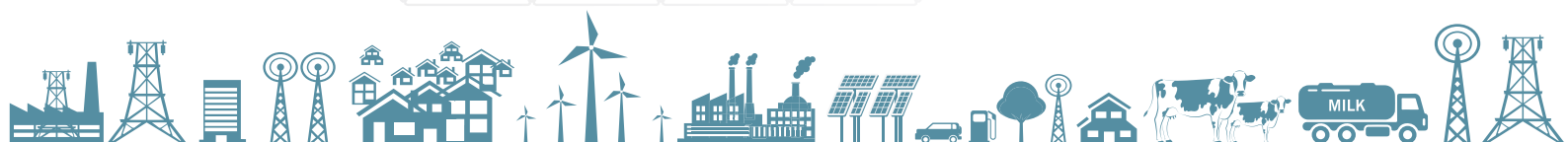

Installation Photo	
Assumptions Made	❖ Fuel Cost – INR 7/kg ❖ GCV of fuel – 16,736 kJ/kg
Savings (INR lakh)	₹ 0.64
Investment (INR lakh)	₹ 0.60
Simple Payback Period	12 months
Replication potential	In all the dairy units irrespective of size and milk chilling centres.
Outcomes	❖ 9,198 kgs of biomass saved annually. ❖ Increase in feed water temperature.
Unit contact details	Mr. Arun Dairy Manager Central Products Dairy – Kozhikode, MRCMPU region Mail Id : cpdkkd@malabarmilma.coop Phone No : 04952414117
Cluster Reference	Madhya Pradesh Dairy Cluster

Vendor Details

Table 20: Vendor Details – Condensate Recovery Systems

Equipment Detail	Energy Efficient Boiler
Supplier 1	
Supplier Name	Forbes Marshall
Address	Forbes Marshall, II / 147 A, Nereveetil Building, Thuruthparambu Road, Vazhakkala, Thrikkakkara P.O., Kochi
Contact Person	Mr. Dileep Cherian
Mail Id	cochin@forbesmarshall.com
Phone No	9995752525 / 9744133211
Supplier 2	
Supplier Name	Thermax Pvt Ltd
Address	PLOT NO. 21/1, 21/2 & 21/3, SAVLI INDUSTRIAL ESTATE, Vadodara, Gujarat
Contact Person	Mr. Sanskar Jayaswal
Mail Id	sanskar.jayaswal@thermaxglobal.com
Phone No	+91 9739811416

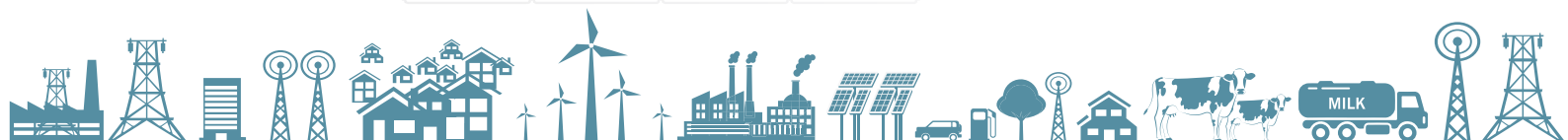

4.1.3 Steam Operated Pumping Traps

Baseline Scenario

The unit has installed No. 2 TPH @10.5 bar three pass solid fuel boiler, and 1 No. 1 TPH @ 10.5 bar three pass solid fired boiler are installed in the plant. Both boilers are at same boiler house, and at any time only one boiler is working. Majority of the time, 2 TPH solid fuel boiler is running to cater the steam demand. The other boiler will be running when the 2 TPH boiler is under maintenance or cleaning. Processing plant is operating for 16 hrs (2 shift / day). All the heating process in dairy is through indirect heating. Boiler details are given below:

Table 21: Boiler details

Boiler	Fuel Type	Design Capacity (TPH)	Make of the company	Operating Pressure (bar)	Operating Condition	Operating hrs
Boiler 1	Briquette Fired	2 TPH	Thermax	6-9	Running	16

Feed water tank of 10 KL capacity is used for supplying of feed water to both boilers. The feed water tank is at a height of 5 m from ground level and is without level controller and Deaerator head. 45°C is achieved using condensate recovered from ghee boiler with the steam trap itself.

The outlet of both the boilers are connected to a main header through different pressure reducing stations to reduce the pressure to 3.5 kg/cm². From the header, different lines are given to Processing plant (50 NB) Ghee Vat (50 NB), Curd Section(50 NB), CIP(65 NB), and Tray Washer(40 NB). All the steam consuming equipment are using 3 kg/cm² pressure, and except Milk Pasteurizer, balance all are indirect heating.

The steam consuming equipment includes below listed processing vessels.

- ❖ Milk Pasteurizer – 2 Nos. 2 X 10 Kl (1 No. 10 Kl is working at a time, Steam injection is direct)
- ❖ CIP – 2 Nos. 2 X 10 Kl
- ❖ Ghee vat – 2 Nos. 1 X 2000 kg, and 1 X 1500 kg.
- ❖ Curd Pasteurizer – 1 No. 1 X 5 Kl
- ❖ Tray washer – 2 Nos.

Curd Pasteurizer and CIP are installed with 25 NB Ball Float Steam Trap. The temperature control valve is also installed, and the PID is enabled. The bypass is open for all the equipment at times. We could see the steam coming out through bypass. The ghee kettle is installed with Inverted Bucket traps. No automatic air vents are provided.

Since the PID temperature control valves are installed at Curd Pasteurizer and CIP, and the temperature requirement is at 90 - 110 °C, chances of stalling of condensate is there and because of that while operating the bypass of the trap is open at times. This results in loss of steam through the bypass. Also the steam pressure is given at 3.5 kg/cm² which can be even bring down to less than 2 kg/cm². In Ghee vat, due to the bucket trap operation, steam will be leaked and is fed to feed water tank. The steam flow to the Heat Exchanger is regulated by a PID based Temperature Control Valve (TCV) which is taking feedback from the temperature sensor

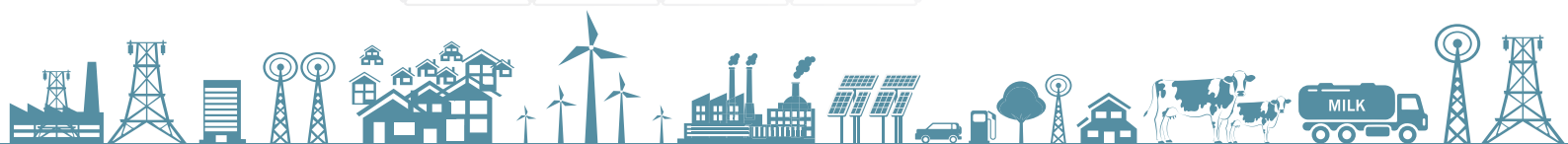

(RTD) at the outlet hot water line. Now, as the set temperature of hot water is attained, the TCV tends to close position. This in turn causes the steam flow rate, and thus steam pressure be reduced, which in turn causes water logging at the steam trap due to the lack of required differential pressure across the trap.

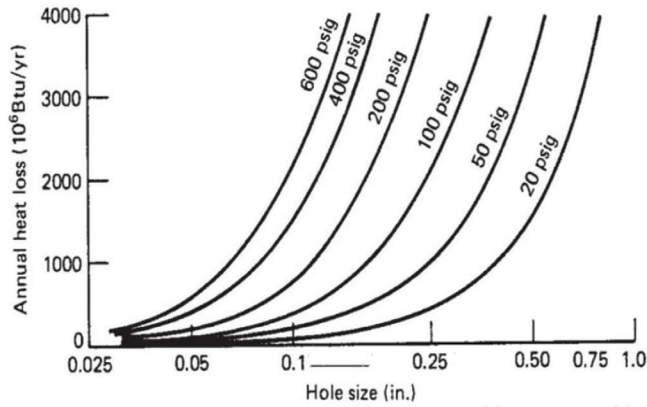

Figure 20: Steam Loss Chart

A steam trap will be operational only above the rated minimum differential pressure. Normally, operation of a steam trap requires a minimum differential pressure of 0.1 kg/cm², however, this may vary with manufacturers. If the condensate flow pressure is lesser than the minimum required differential pressure, water logging happens which is also called stalling. This leads to problems of hammering, reduction of thermal performance of heat exchanger, corrosion of heating surfaces, inevitably reducing the service life of the exchanger.

Now, to avoid this stall condition of steam traps, equipment operator normally operates the by-pass valve, either keeping bypass line partially open full-time or intermittently opening and closing it. In both the cases, live steam loss occurs, thereby increasing the energy consumption. The orifice size of 15 NB bypass valve open is 5 mm at 3.5 kg/cm² operating pressure. Through this orifice size, steam loss is 30 kg/hr from the steam loss chart.

Proposed System

It is recommended to replace the ball float steam trap with Steam Operated Pumping Trap (SOPT). With this system in place, whenever the condensate pressure is low, motive steam/ air shall provide the additional thrust to make the condensate flow and avoid any stalling.

Merits

- ❖ Improved condensate recovery.
- ❖ Reduced steam leakages through the system.

Limitations

- ❖ Proper maintenance is required.

Cost Benefit Analysis

The expected fuel savings by installation of SOPT is 0.22 lakh kgs of briquette annually. The annual monetary saving for this project is **INR 1.61 lakh, with an investment of INR 4.00 lakh, and the payback for the project is 30 months.**

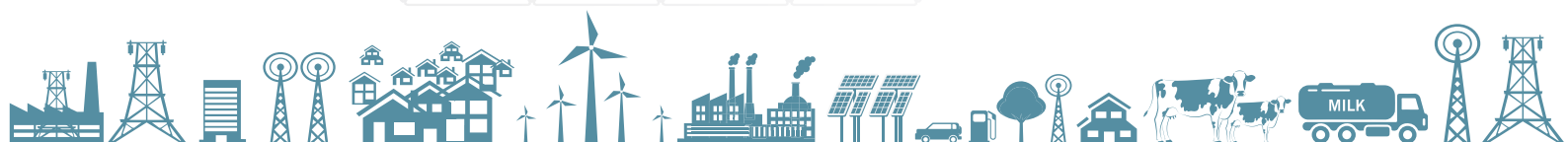
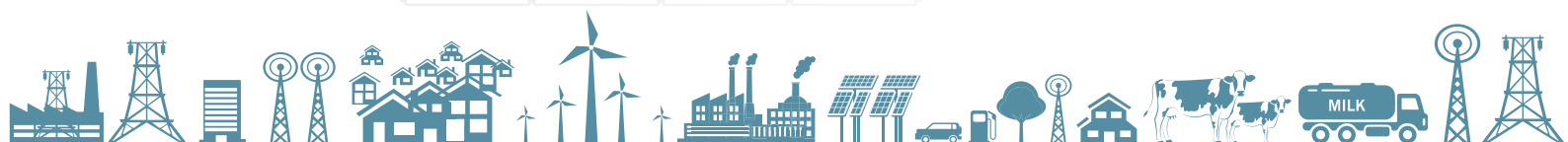

Table 22: Cost Benefit Analysis – Installation Steam Operated Pumping Traps

Parameters	UOM	
Orifice Size	mm	5
Operating Pressure	bar	3
Steam loss through orifice	kg/hr	30
Considering 50% live steam leakage	kg/hr	15
Hence steam leakage/day from single bypassed trap (Considering average running 5 hrs/day)	kg/day	75
Total no of by-passed traps	nos	4
Total steam leakage	kg/day	300
Steam Cost	Rs/kg	1.48
Operating days		360.00
Fuel Loss	kg/day	63.83
Fuel Cost	INR/kg	7
Annual Fuel Savings	kg	22,978.72
Monetary Savings	INR lakh	1.61
Investment	INR lakh	4.00
Pay Back	months	30
IRR	%	58.75
NPV at 70% debt (12% rate)	INR lakh	6.33

Energy & GHG Savings



Reference Plant Implementation

Table 23: Reference Implementation – Automatic Pumping Trap

Project Name	Installation of Condensate Recovery System
Objective	Recovery of condensate with automatic pumping trap
Unit profile	Ernakulam Dairy- a unit under Ernakulam Regional Co-operative Milk Producers' Unions (ERCMPU) of MILMA having its plant at Thrissur, Ernakulam, Kerala offers pasteurized Vitamin – A enriched milk and various milk-based products such as Butter, Curd, Ghee and Sambharam throughout the state.
Installation Photo	
Assumptions Made	<ul style="list-style-type: none"> ❖ Fuel Cost – INR 7/kg ❖ GCV of fuel – 17,752 kJ/kg ❖ Boiler efficiency -70%
Savings (INR lakh)	₹ 6.80
Investment (INR lakh)	₹ 4.00
Simple Payback Period	7.4 months
Replication potential	In all the dairy units irrespective of size and milk chilling centers.
Outcomes	<ul style="list-style-type: none"> ❖ 97,085 kgs of biomass saved annually. ❖ Increase in feed water temperature.
Unit contact details	<p>Mr. Babu Varghese Milma Ernakulam Dairy, ERCMPU region Mail Id : ernakulamdairy@yahoo.co.in Phone No : 0484-2780103</p>
Cluster Reference	Madhya Pradesh Dairy Cluster

Vendor Details

Table 24: Vendor Details – Steam Operated Pumping Traps

Equipment Detail	Steam Operated Pumping Traps
Supplier 1	
Supplier Name	Forbes Marshall
Address	Forbes Marshall, II / 147 A, Nereveetil Building, Thurutheparambu Road, Vazhakkala, Thrikkakkara P.O., Kochi
Contact Person	Mr. Dileep Cherian
Mail Id	cochin@forbesmarshall.com
Phone No	9995752525 / 9744133211

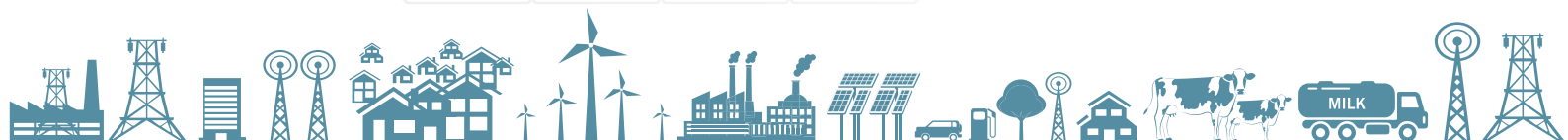

4.2 Case Studies in Refrigeration Systems

4.2.1 Installation of screw refrigeration compressor

Baseline Scenario

The unit has five reciprocating chiller compressors of 90 kW and 70 TR each, based on vapor compression ammonia cycle. These compressors cater to the chilled water requirements and FCU units in the cold storage area. Of the five compressors installed, two compressors are running during morning time and three compressors are running during night time for ice formation in the IBT. The performance of the chiller compressor is shown below:

Table 25: Operating Parameters of compressors

Parameters	UOM	
Rated Refrigeration Capacity (2 x 70 TR)	TR	140
Rated Power (2 x 90 kW)	kW	180
Design SEC	kW/TR	1.29
Condensing Temp	°C	35 to 40
Suction Pressure	psi	35-55
Discharge Pressure	psi	177-79
Discharge Temperature	°C	100 to 110
Total Operating Power	kW	122
Total Operating TR	TR	92
Operating SEC	kW/TR	1.33

Currently the reciprocating compressor is running continuously at full load irrespective of the load variations in the plant and operating SEC is 1.33 kW/TR which is on higher side. As in any dairy processing unit, during the day time, when all the processes (mainly pasteurization and pre chilling of raw milk) are in operation, the compressor is 80% to 100% loaded, and consumes more power. During the night, the cooling requirement drops and the compressor runs only for the purpose of maintaining the temperature on the Ice Bank Tank (IBT). During this time the total refrigeration load on the plant is less, but still the compressor takes the same power as it was consuming during the peak load.

Proposed System

It is recommended to replace the existing reciprocating compressors with 155 TR screw compressor equipped with VFD. The table below shows the comparison of screw and reciprocating compressor:

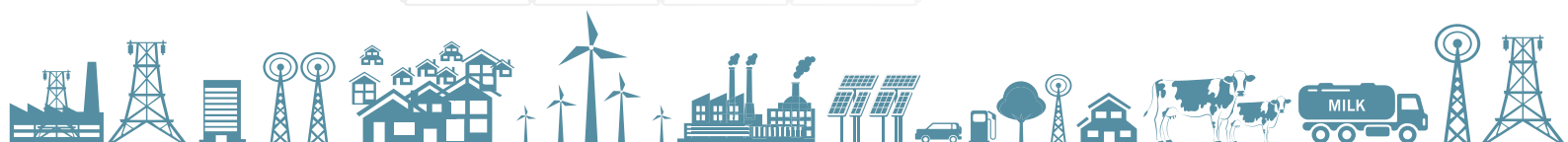

Table 26: Comparison between screw and reciprocating compressor

Comparison Between Screw Compressor and Reciprocating Compressor	
Screw Compressor	Reciprocating Compressor
Fully automatic and has variable capacity control system from 10 to 100%. This means at any % of capacity, screw would operate precisely at this point and power consumption will be linear correspondingly, which means compressor perform at peak efficiency under varying load condition.	Unloaded step-wise only, that means partial loads operate at lower suction than designed suction which load to lower volume efficiency and high-power consumption resting in higher KW/ TR.
Ideal for larger plant as they can reduce installation cost, installed power and space by eliminating 3 to 4 reciprocating compressors.	Ideal for small plant. Spares inventory for maintaining 3 to 4 reciprocating compressors more/ high.
BKW / TR is on lower side at any suction temperature	Always on higher compare to screw.
Connected motor rating also less	High compare to screw.
Direct coupled. No belt loss.	Belt direction minimum 3% for belt losses.
No tolerance required.	Tolerance required at 2.5%.
Fewer moving party and simple rotation motor which means less maintenance, vibration levels, less friction loss.	Many moving parts. That means high repair cost.
Having efficient oil separation system for better oil management and low oil carry loss.	Oil carry over more.
Having PLC based control panel which constantly monitor the system and maintain most efficient operation condition.	Through manual cutouts.

The screw compressor with VFD proposed for the plant will operate at lower kW/TR of 1.00 compared to 1.33 kW/TR when operating with reciprocating compressor. Also, the VFD installed along with compressor will result in smooth control of operation as the suction pressure is given as feedback to the compressor. Based on the refrigeration load, the refrigerant temperature required will vary, hence the suction pressure. During the light load condition when the pasteurization process stops, compressor runs only to maintain IBT temperature and to maintain the temperature in cold storage during this time, with suction pressure as the feedback. Once the evaporator achieves the desired temperature, with proper feedback, the speed of the compressor can be reduced and hence power savings can be achieved.

Merits

- ❖ Variable Volume Ratio control.
- ❖ Efficient Oil Separation & low oil carry over.
- ❖ PLC based system for efficient operation.
- ❖ Higher reliability of operation.
- ❖ Reduced maintenance.

Limitations

- ❖ Higher installation costs.

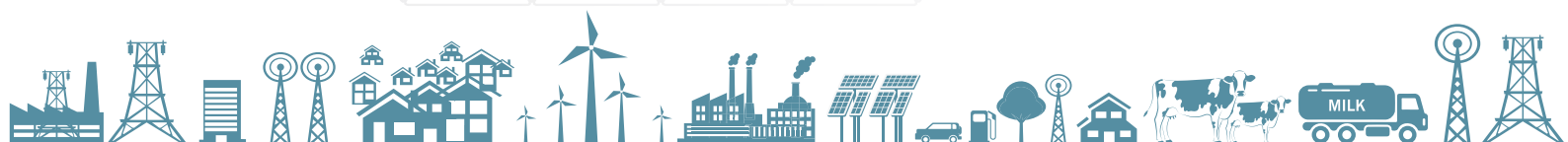

- ❖ May require system stoppage during installation.

Cost Benefit Analysis

The expected savings by installation of Screw Compressor with VFD is 2,79,690 units of electricity annually. The annual monetary saving for this project is **INR 15.38 lakh with an investment of INR 52.00 lakh, and the payback for the project is 41 months.**

Table 27: Cost Benefit Analysis – Installation of Screw Compressor

Parameters	UOM	
Rated Refrigeration Capacity (2 x 70 TR)	TR	140
Rated Power (2 x 90 kW)	kW	180
Design SEC	kW/TR	1.29
Condensing Temp	°C	35 to 40
Suction Pressure	psi	35-55
Discharge Pressure	psi	177-79
Discharge Temperature	°C	100 to 110
Total Operating Power	kW	122
Total Operating TR	TR	92
Operating SEC	kW/TR	1.33
Recommended Design TR	TR	155
Recommended Design Rate Power	kW	159
New SEC	kW/TR	1.02
New Power Consumption	kW	94.19
Power Savings	kW	28
Energy Cost	INR/kWh	5.5
Operating Hours	hrs	8,600
Savings on VFD	%	5.00
Savings on VFD	kW	4.71
Total Power Savings	kW	33
Annual Energy Savings	kWh	2,79,690
Annual Cost Savings	INR lakh	15.38
Investment	INR lakh	52.9
Payback	Years	41

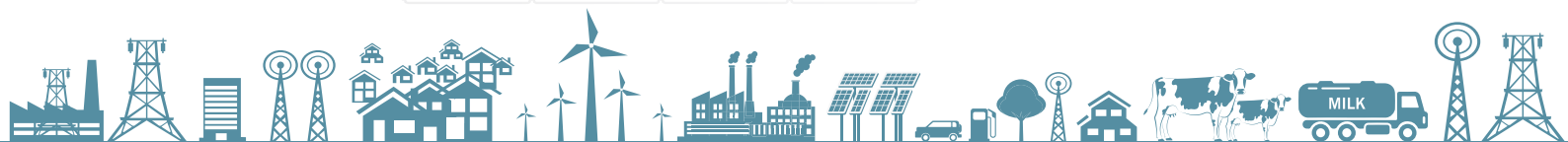

Parameters	UOM	
IRR	%	44
NPV at 70 % Debt (12% rate)	INR lakh	53.75

Energy & GHG Savings



Reference Plant Implementation

Table 28: Reference Implementation – Installation of screw refrigeration compressor

Project Name	Installation of Screw Refrigeration Compressor
Objective	Replacement of old reciprocating chiller with Screw chiller
Unit profile	Trivandrum dairy- a unit under Thiruvananthapuram Regional Co-operative Milk Producers' Unions (TRCMPU) of MILMA having its plant at Ambalathara, Trivandrum, Kerala offers pasteurized Vitamin – A enriched milk and various milk-based products such as Butter, Ghee, Paneer, Curd, Butter milk and Ice cream throughout the state.
Installation Photo	
Assumptions Made	<ul style="list-style-type: none"> ❖ Electricity Cost – INR 6.65/kWh ❖ SEC of old reciprocating chiller – 1.60 kW/TR ❖ Operating hrs/day – 24 hrs
Savings (INR lakh)	₹ 32.87
Investment (INR lakh)	₹ 79.66
Simple Payback Period	29 months
Replication potential	In all the bigger dairy units having refrigeration load greater than 100 TR.

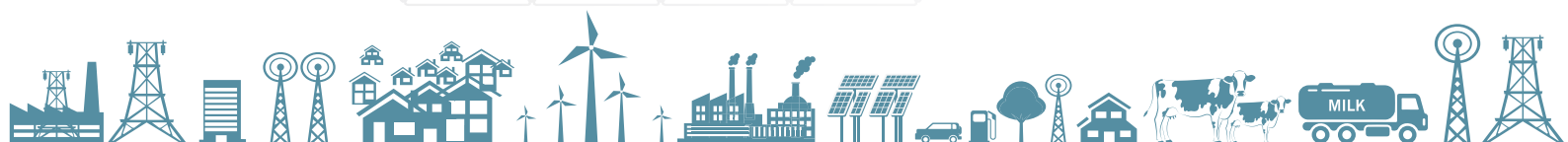

Outcomes	❖ 4.94 lakh units of electricity saved annually. ❖ Annual energy reduction of 42.49 TOE
Unit contact details	Mr. Balasubramony G Milma Thiruvananthapuram Dairy, TRCMPU region Mail Id : milmatdengg@gmail.com Phone No : 0471-2382562, 2382148
Cluster Reference	Madhya Pradesh Dairy Cluster

Vendor Details

Table 29: Vendor details – Screw Compressor (Refrigeration)

Equipment Detail	Screw compressor with VFD
Supplier Name	Frick India Ltd
Address	New No. 243 (Old No. 185) Anna Salai, Chennai – 600 006
Contact Person	Mr. T.T.Krishnamoorthy
Email Id	ttk@frickmail.com
Phone No	9444818846

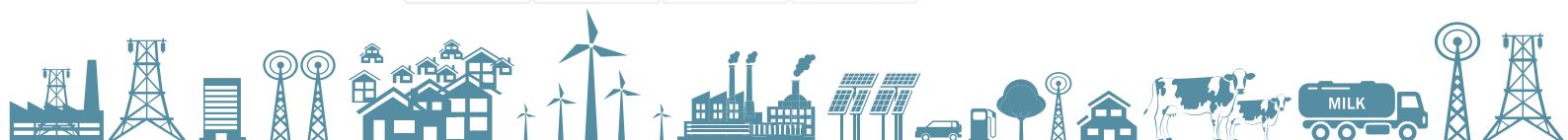

4.2.2 VFD in Reciprocating Chiller Compressor

Baseline Scenario

The dairy unit has installed five reciprocating chiller compressors of 33 TR each, based on vapor compression ammonia cycle. These compressors cater to the chilled water requirements and Fan Coil Unit (FCU) in the cold storage area. Of the five compressors installed, two compressors are running in morning time, and three compressors run during night time for ice formation on the IBT. The performance of the chiller compressor is shown below:

Table 30: Operating Parameters of compressors

Parameters	UOM	
Rated size of compressor	kW	33
Rated Capacity	TR	45
No of Compressors in operation	Nos	2
Compressor 1 Power	kW	41.60
Compressor 5 Power	kW	38.90
Suction Pressure Compressor 1	psi	30
Suction Pressure Compressor 5	psi	39
Discharge Pressure Compressor 1	psi	196
Discharge Pressure Compressor 5	psi	190
Discharge Temperature	°C	92
Condensing Temperature	°C	38
Total Operating Power	kW	80.50
Operating TR	TR	51.93
SEC	kW/TR	1.55

Currently, the reciprocating compressor is running continuously at full load irrespective of the load variations in the plant. As in any dairy processing unit, during the day time, when all the processes (mainly pasteurization and pre-chilling of raw milk) are in operation, the compressor is 80% to 100% loaded, and consumes more power. During night, the cooling requirement drops and the compressor runs only for the purpose of maintaining the temperature on the Ice Bank Tank (IBT). During this time the total refrigeration load on the plant is less but still the compressor takes the same power as it was consuming during the peak load, because there is no speed control mechanism.

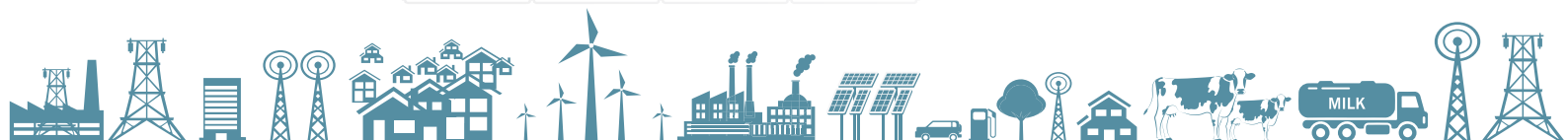

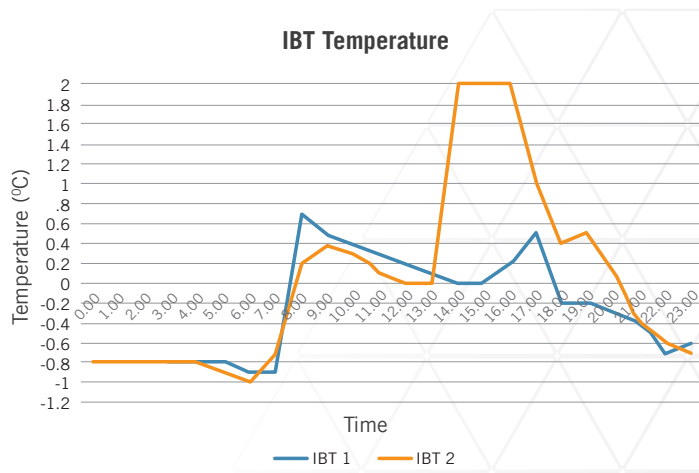

The figure here shows the temperature profile of IBT for a duration of 24 hrs. It is seen that at night the temperature is subzero for IBT 2 and IBT 1. During this time, the compressor is running only to maintain ice on the IBT and for the cold store rooms. Plant is running two low speed compressors during night time without any speed control.

Figure 21: IBT temperature profile

Total compressor power for a system is a function of its suction pressure, discharge pressure, total system load, part load controls and unloading (specifically in the case of screw compressors which do not unload linearly). A lower refrigerant temperature results in lower suction pressure and increased compressor power requirements. A lower condensing pressure, which is a function of the condenser capacity and operations, results in a lower compressor discharge pressure and less compressor power. The above figure shows the variation of SP with time for the compressors installed in the plant. It is seen that Compressor 1 is operating with a higher suction during day time due to high demand and compressor 2 is operating with SP of 30 psi. During the 20:00 pm third compressor is also switched on and it is clearly seen that SP of compressor 1 drops to 28 PSI during this time, and all the compressors are running at low suction which clearly indicates low demand of load. During night time there is a good potential for VFD as it can reduce the speed of one compressor based on suction and help in reducing power consumption.

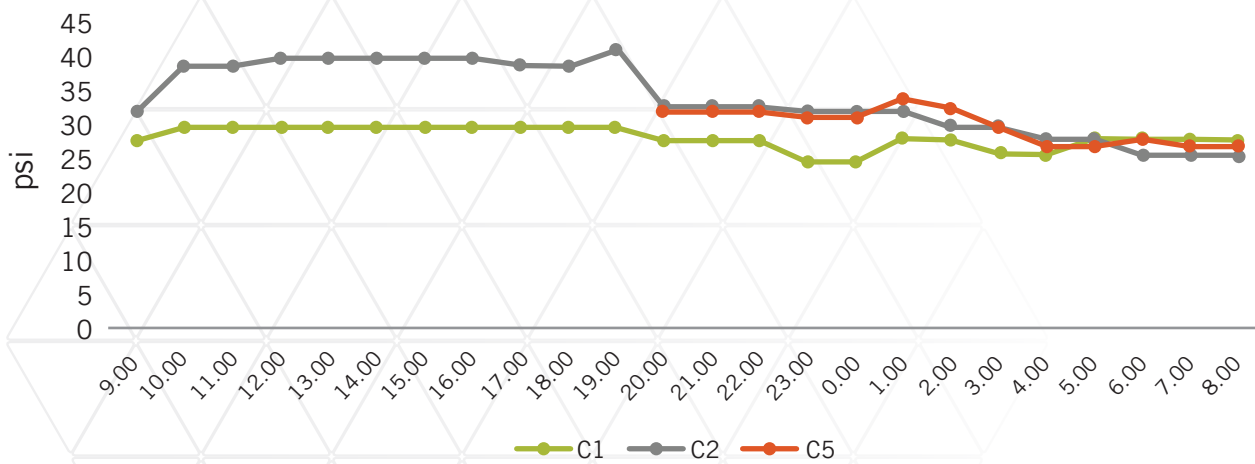
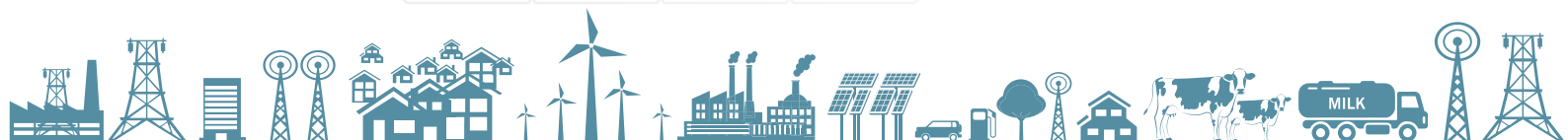

Figure 22: Compressor Suction Pressure

Once the evaporator gets wet with the help of refrigerant and temperature is attained, if there is no speed control the compressor will do the same work to attain lower refrigerant temperature which results in lower suction pressure thereby consuming same power as it is loaded. In such cases VFD can reduce the power consumption with the help of speed control by proper feedback mechanism.



Proposed System

It is recommended to install VFD for one high speed compressor with suction pressure as the feedback. The VFD helps in smooth control of operation of the compressor and the high-speed compressor can take care of the load, when suction pressure of the low speed compressor exceeds the set value. At this time, the compressor with VFD can take care of the additional demand due to increased suction.

Merits

- ❖ Better operating efficiencies.
- ❖ Reduced power consumption.
- ❖ Smooth control of compressor.
- ❖ VFD can act as a soft starter.

Limitations

- ❖ Speed reduction is possible up to only 25 Hz.

Cost Benefit Analysis

The expected electricity savings by installation of VFD for refrigeration compressor is 25,200 units annually. The annual monetary saving for this project is **INR 1.38 lakh with an investment of INR 2.66 lakh, and payback for the project is 23 months.**

Table 31: Cost Benefit Analysis – VFD for Refrigeration Compressor

Parameters	UOM	
Total Compressor Power	kW	80.50
Refrigeration Load	TR	51.93
SEC	kW/TR	1.55
VFD Power Savings	%	10
Power Savings on one compressor	kW	4.2
Operating hours	hrs	6,000
Energy Savings	kWh	25,200
Cost Savings	INR lakh	1.38
Investment	INR lakh	2.66
Payback Period	months	23
IRR	%	73.04
NPV at 70 % Debt (12% rate)	INR lakh	5.78

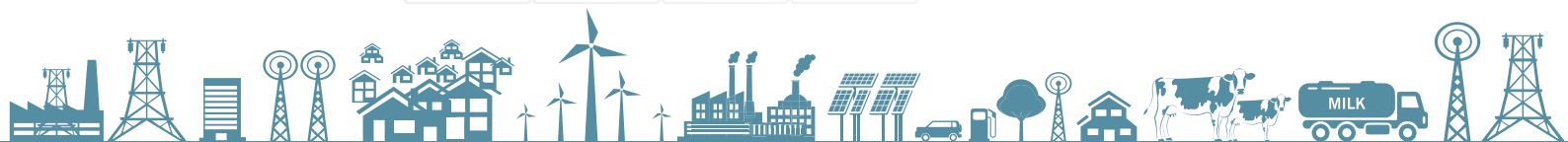

Energy & GHG Savings



Reference Plant Implementation

Table 32: Reference implementation: Installation of VFD for reciprocating chiller

Project Name	Installation of VFD for reciprocating chiller
Objective	Installation of VFD for reciprocating chiller to reduce power consumption
Unit profile	Milma Thrissur Dairy - a unit under Ernakulam Regional Co-operative Milk Producers' Unions (ERCMPU), having its plant at Mannumkad, Ramavarmapuram, Kerala offers pasteurized Vitamin – A enriched milk and products such as Curd and Ghee throughout the state.
Installation Photo	
Assumptions Made	<ul style="list-style-type: none"> ❖ Electricity Cost – INR 6.65/kWh ❖ Operating hrs – 12 hrs/day
Savings (INR lakh)	₹ 2.48
Investment (INR lakh)	₹ 2.60
Simple Payback Period	13 months
Replication potential	In all the dairy units irrespective of size
Outcomes	<ul style="list-style-type: none"> ❖ 37,274 units of electricity saved annually ❖ Smooth operation of compressor
Unit contact details	Mr. Rajesh MR Milma Thrissur Dairy, ERCMPU region Mail Id : ercputdengg@milma.com Phone No : 9446535064
Cluster Reference	Madhya Pradesh Dairy Cluster

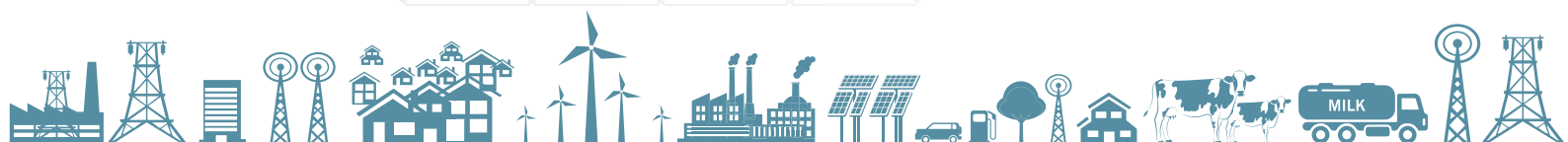

Vendor Details

Table 33: Vendor details – VFD for Refrigeration Compressor

Equipment Detail	VFD for chiller compressor
Supplier Name	Danfoss Industries Ltd
Address	703,7th Floor, Kaivanya Complex,Near Panchwati Cross Road Ambawadi, Ahmedabad
Contact Person	Mr. Srihari Vyas
Email Id	Shrihari@danfoss.com
Phone No	9825024991

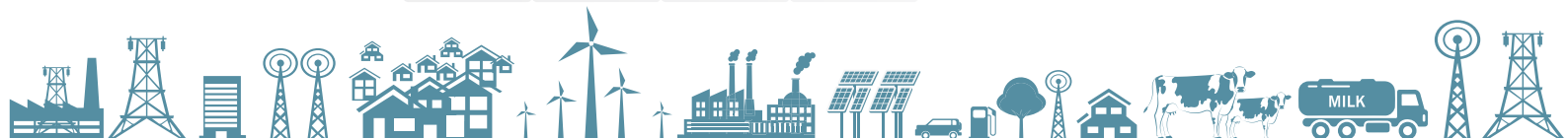

4.2.3 Replacement of low speed reciprocating compressor with high speed reciprocating chiller

Baseline Scenario

The unit has installed three 30TR reciprocating chiller compressors for the chilled water requirement in the plant and Fan coil units for the cold store units. During normal operation one 30TR is running continuously and second compressor runs for eight hours at night. IBT is maintained at 0°C to 0.5°C. The chilled water is supplied to process at 4°C. The performance parameters of chiller compressor which is running continuously is given below:

Table 34: Chiller compressor performance

Parameters	UOM	
Rated size of compressor	kW	45
	TR	30
Voltage	Volts	410
Current	Amperes	66.4
Power Consumption of Compressor	kW	42
Power Factor	PF	0.90
Suction Pressure	Bar	27
Discharge Pressure	bar	191
Discharge Temperature	°C	85
Condensing Temperature	°C	37
Operating Power	kW	42
Operating TR	TR	25
SEC	kW/TR	1.65

It has been observed that the SEC of the compressor is on higher side 1.65 kW/TR. Currently the plant is having low speed compressor whose SEC by design is in the range of 1.5 kW/TR. Also, for low speed compressor the maintenance cost is on higher side. The plant is running an extra compressor at night for 8 hours to maintain the IBT temperature. Low speed compressors generally consume more power at reduced loads due to poor capacity control technique.

Proposed System

It is recommended to replace the existing compressor with a high-speed reciprocating compressor. High Speed compressors run at a maximum of 1200 RPM, and all are provided with built-in capacity reduction steps for economical operation at reduced loads. With the

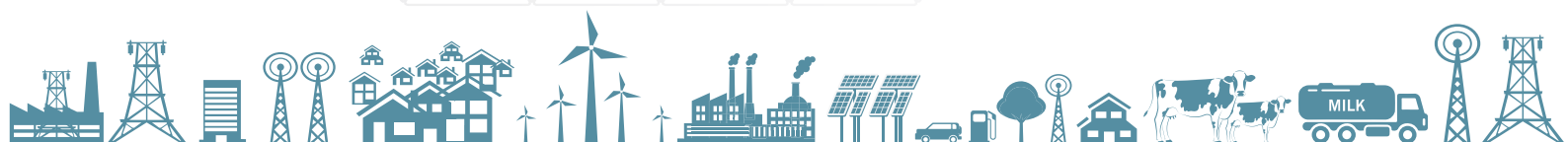

High Speed you will get maximum capacity in a minimum amount of space. They also unload smoothly which results in better efficiency and thereby power savings.

Merits

- ❖ High efficiency and high performance.
- ❖ Smooth unloading system for power saving.
- ❖ Oil pressure is maintained even at very low suction pressure.
- ❖ Advanced filter removes 95% of contaminants as small as 3 microns in size.
- ❖ Low vibration and noise.

Demerits

- ❖ High upfront cost.
- ❖ Requires system modification.

Cost Benefit Analysis

The expected electricity savings to be achieved by installation of high-speed reciprocating compressor is 0.66 Lakh units annually. The annual monetary saving for this project is **INR 3.74 lakh, with an investment of INR 8.00 lakh, and a payback period of 26 months.**

Table 35: Cost savings for high speed reciprocating compressor

Parameters	UOM	
Compressor Power	kW	42
Refrigeration Load	TR	25.45
Operating SEC	kW/TR	1.65
New Compressor Power	kW	34.36
Refrigeration Load	TR	25.45
New Compressor SEC	kW/TR	1.35
Power Savings	kW	7.63
Operating hrs	hrs	24.00
No of days	days	360.00
Energy Cost	INR/kWh	5.60
Energy Savings	kWh	66,839
Cost Savings	INR lakh	3.74
Investment	INR lakh	8.00
PB	months	26

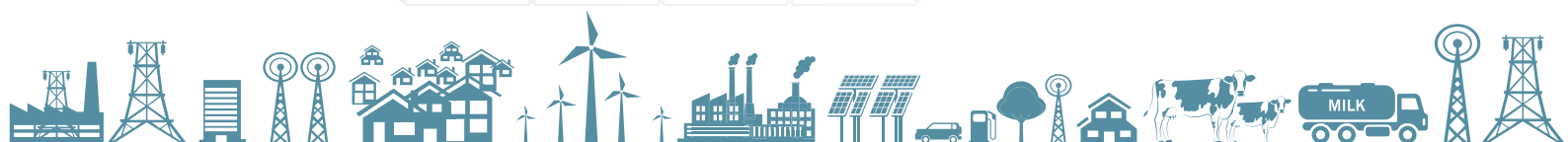

Parameters	UOM	
NPV at 70% Debt	INR lakh	15.30
IRR (%)	%	66.83

Energy & GHG Savings



Reference Plant Implementation

Table 36: Reference Implementation – Installation of high-speed reciprocating compressor

Project Name	Installation of High-Speed Reciprocating Compressor
Objective	Replacement of old low speed reciprocating chiller with high speed chiller
Unit profile	Milma Thrissur Dairy - a unit under Ernakulam Regional Co-operative Milk Producers' Unions (ERCMPU), having its plant at Mannumkad, Ramavaramapuram, Kerala offers pasteurized Vitamin – A enriched milk and products such as Curd and Ghee throughout the state.
Installation Photo	
Assumptions Made	<ul style="list-style-type: none"> ❖ Electricity Cost – INR 6.65/kWh ❖ Operating hrs/day – 12 hrs
Savings (INR lakh)	₹ 15.18
Investment (INR lakh)	₹ 9.00
Simple Payback Period	7 months
Replication potential	In all the dairy units having low speed reciprocating compressor
Outcomes	<ul style="list-style-type: none"> ❖ 2,28,293 units of electricity saved annually. ❖ Annual energy reduction of 19.63 TOE

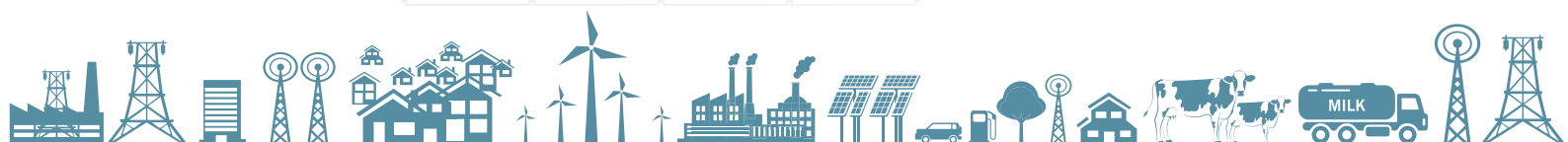

Project Name	Installation of High-Speed Reciprocating Compressor
Unit contact details	Mr. Rajesh MR Milma Thrissur Dairy, ERCMPU region Mail Id : ercputdengg@milma.com Phone No : 9446535064
Cluster Reference	Madhya Pradesh Dairy Cluster

Vendor Details

Table 37: Vendor details: High speed reciprocating compressor

Equipment Detail	High Speed Reciprocating compressor
Supplier Name	Frick India Ltd
Address	New No. 243 (Old No. 185) Anna Salai, Chennai – 600 006
Contact Person	Mr. T.T.Krishnamoorthy
Email Id	ttk@frickmail.com
Phone No	9444818846

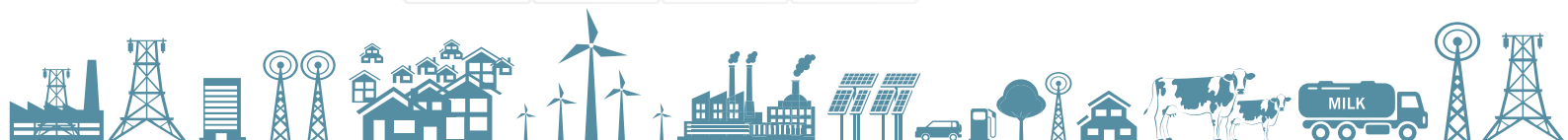

4.2.4 Energy efficient submersible agitators for IBT

Baseline Scenario

The unit has installed three reciprocating chiller compressors of 33 TR capacity each, for chilled water requirement in the plant. During morning time two compressors will be running to meet the process chilled water requirement and for cold store rooms. During night shift three compressors will be running to develop ice in the IBT and for the cold rooms. The unit has 3 IBT of 5000 litres capacity to generate chilled water at 0°C to 0.5°C, from where chilled water is drawn for cooling the stored milk before processing and after the pasteurization. The load on the plant keeps varying as milk is delivered from different sources at different point of times and at different temperatures.

In IBT the ice is formed over the ammonia tubes and water around this ice is drawn during the cooling needs. The ice around the ammonia tubes are expected to be crystal clear to possess good amount of latent heat so that ice lasts quite longer. The water in the tank if stagnant and has air/ gaseous substances, will form an opaque ice over the ammonia tubes which melts easily as it will have lesser latent heat. To ensure removal of entrapped air / gas from the water, a vertical agitator of 5 HP is used at one end of the IBT to push water into circulation.

Proposed System

It is recommended to replace the existing three vertical agitators with energy efficient submersible agitators of 1Hp each. The sizing of the mixers is based on the tank dimensions and effective volume of water to be circulated. The mixers are installed inside the tank with proper angles to the tank walls and at optimum heights from the tank bottom to ensure smooth uniform water circulation of water inside the tank. The net result is crystal clear ice formation over the ammonia tubes and with uniform thickness all around and length.



Figure 23: Submersible agitators

Merits

- ❖ Low power consumption.
- ❖ Uniform water circulation
- ❖ Ensure proper stirring of chilled water

Demerits

- ❖ Investment cost

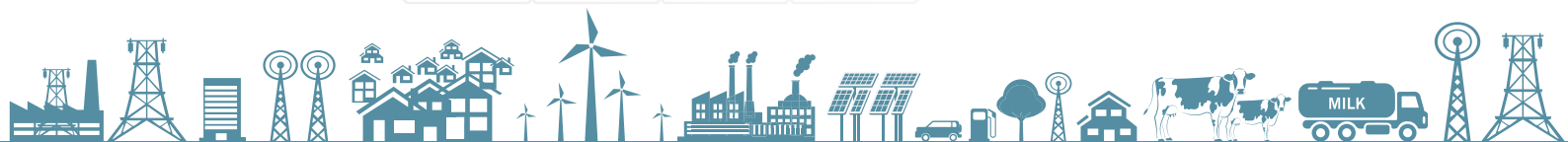

Cost Benefit Analysis

The expected electricity savings to be achieved by installation of submersible agitator is 0.77 Lakh units annually. The annual monetary saving for this project is **INR 4.26 lakh, with an investment of INR 4.50 lakh, and a payback period of 13 months.**

Table 38: Cost Benefit Analysis – EE agitator for IBT

Parameters	UOM	
Power consumption of old agitator	kW	3.7
Total power consumption of 3 agitators	kW	11.1
Power consumption of new agitator	kW	0.75
Total power consumption of 3 new agitators	kW	2.25
Total Power Savings	kW	8.85
Power Cost	INR/kWh	5.5
Operating Hours	hrs/day	24
No of Days	days/year	365
Annual Energy Savings	kWh	77,526
Annual Cost Savings	INR lakh	4.26
Investment for 3 agitators	INR lakh	4.50
Payback	months	13
IRR	%	170.95
NPV at 70 % Debt (12% rate)	INR lakh	20.21

Energy & GHG Savings



Reference Plant Implementation

Table 39: Reference implementation: Energy efficient agitators

Project Name	Installation of EE submersible agitators
Objective	Replacement of 6 old agitators of 5.5 kW each with EE submersible agitators of 0.75 kW.
Unit profile	Sumul or Surat Milk Union Limited, which is now renamed as The Surat District Co-operative Milk Producers' Union Ltd, is one among the 17 district unions which acts as manufacturing units of dairy products for Gujarat Co-operative Milk Marketing Federation Limited, the marketers of Amul brand of products. The dairy has a daily average processing capacity of 15 lakh litres of milk per day.
Installation Photo	
Assumptions Made	<ul style="list-style-type: none"> ❖ Electricity Cost – INR 5.5/kWh ❖ Operating hrs/day – 24 hrs ❖ Tank volume : 67 m³
Savings (INR lakh)	₹ 13.49 lakh
Investment (INR lakh)	₹ 10.50 lakh
Simple Payback Period	4 months
Replication potential	In all the dairy units having old vertical agitators
Outcomes	2.45 lakh units of electricity saved annually.
Unit contact details	Mr. AB Shah Sumul Dairy, Surat, Gujarat Mail Id: abs@sumul.coop Phone No: 099798 88018
Cluster Reference	Gujarat Dairy Cluster

Vendor Details

Table 40: Vendor Details – EE agitator

Equipment Detail	Submersible EE agitator
Supplier Name	Grundfos Pumps India Pvt. Ltd.
Address	118, Rajiv Gandhi Salai Chennai 600 097
Contact Person	Mr. Unni Ramachandra Warriar
Mail Id	unni@grundfos.com
Phone No	9895758124

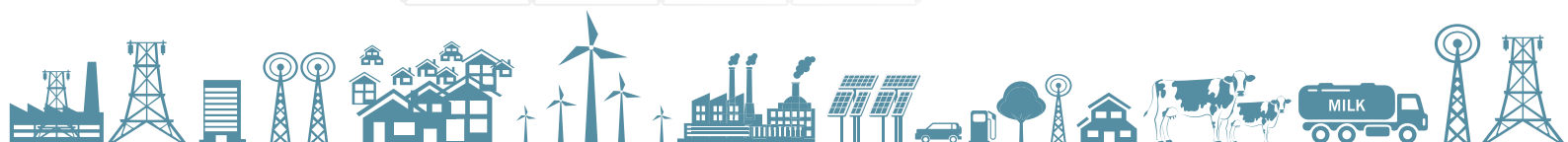

4.2.5 Falling Film Chiller (FFC)

Baseline Scenario

The unit is receiving milk from village level collection center and has bulk milk coolers for processing at different temperatures. To meet the chilling requirement, the unit has installed three reciprocating chiller compressors of 40 TR high speed reciprocating compressor for the chilled water requirement and for the fan coil units at cold storage. Two compressors will be running to meet the peak demand in the plant. The following table shows the performance of chiller compressors:

Table 41: Chiller compressor performance

Parameters	UOM	
Compressor design Power	kW	110
Compressor design load	TR	80
Suction Pressure	kg/cm ²	2.10
Discharge Pressure	kg/cm ²	13-35
Discharge Temperature	°C	95
Evaporator Temperature	°C	-2
Condensing Temperature	°C	40
Operating Power	kW	100
Operating TR	TR	73
SEC	kW/TR	1.37

The incoming milk is received at different temperatures, and as a result, the load on the refrigeration system also fluctuates. The process return water to IBT from prechiller and other processes is also at high temperature, which in turn increases the temperature of IBT. This results in higher chilled water temperature which leads to inefficient chilling of milk. The process return water from pasteurization process is at 7°C – 10°C and from pre-chiller installed at raw milk reception is 9°C – 11°C, due to high incoming temperature of milk. There is an unevenness in the return water temperature, and this is directly going to IBT tank. In the present condition, the average temperature maintained at IBT is 6°C to 08 °C, and as a result, the unit is facing difficulty to maintain 4°C for milk dispatch. Thus, the unit is able to dispatch milk at only 5°C to 6°C. At the current situation, the temperature the plant is getting is around 5°C – 6 °C for milk dispatch, and it is uneven. Because of this, load on the refrigeration plant is also increasing, which results in higher SEC for chiller compressor.

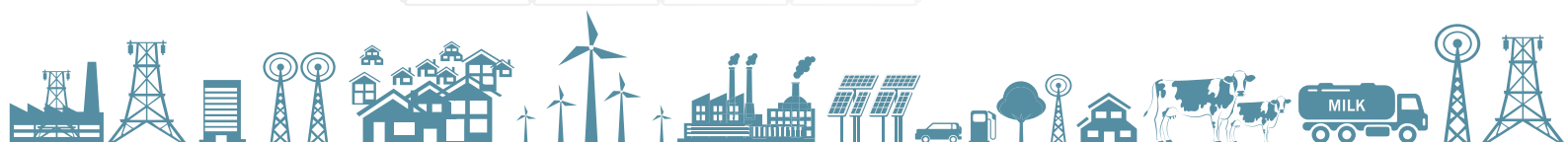

Proposed System

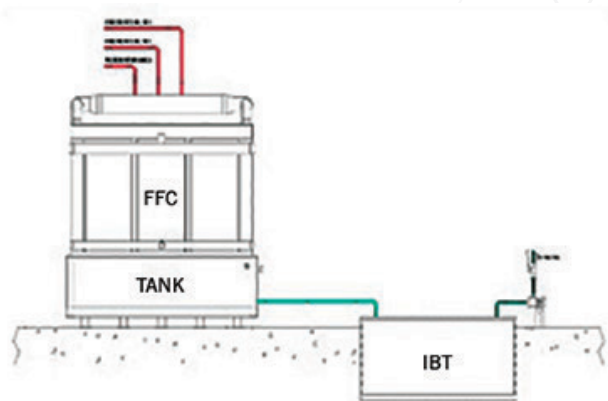

Figure 24: Falling film chiller

It is recommended to install falling film chiller before IBT to pre-chill the incoming process return water at higher temperature. FFC can instantly bring down the process return water temperature to $0.5^{\circ}\text{C} - 1^{\circ}\text{C}$, thus maintaining the IBT temperature less than 0.5°C all the time and thereby reducing the chiller compressor load. The new system will improve the quality of chilled milk and milk products as IBT can continuously generate chilled water at lower temperature and hence meet the requirement of cooling the milk to 4°C .

Falling Film Chillers are suitable for continuous chilling of liquids close to their freezing point (i.e. water to 0.5°C). Also, viscous liquids, detergents, etc., and polluted liquids not easily handled in large quantity by conventional heat exchangers, can all be chilled with the Falling Film Chiller. The water to be cooled is pumped into a distribution tank and as previously described the water is evenly distributed so that it falls as a continuous film over the cooling surface and into a base tank or directly over the product. The refrigerant runs through the pillow plate. It can be either a primary refrigerant such as ammonia, R134a, R22 etc., evaporating directly in the plate, which can be circuited for dry expansion, flooded or pumped systems, or as a secondary refrigerant such as glycol, brine or a similar heat transfer fluid.

When Using NH_3 as the refrigerant, oil drains must be provided in the lowest point of the evaporator (liquid) supply. For flooded systems, the separator liquid level must be a minimum of 0.5 m above the suction when using NH_3 and 1.0 m using R22. Using a falling film chiller with a DX system, a suction gas heat exchanger is required if the temperature difference between refrigerant and water inlet is less than 10°C . This suction heat exchanger provides the gas superheat. The minimum evaporation temperature is -3°C with water of 1°C , and -2.5°C with water of 0.5°C . This is to prevent ice-build-up on the plates.

Conventional IBT often runs at low evaporation temperatures, which results in a lowering of refrigeration capacity and higher power consumption as compared to FFC, which runs at much higher evaporation temperature. The FFC being an open system also results in low or zero maintenance, and therefore is free from such botheration due to which the plant always maintains high efficiency.

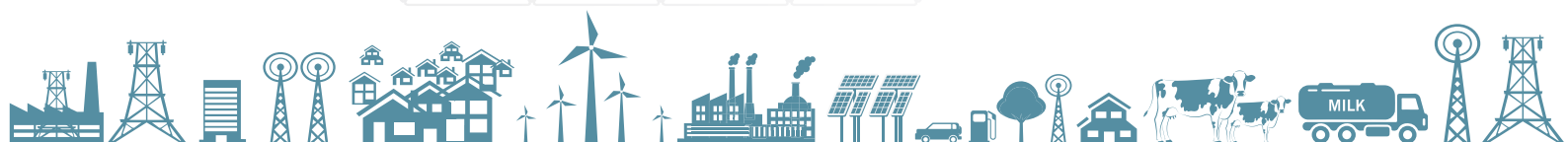

Merits over conventional PHE

Table 42: Falling Film Chiller vs Plate Heat Exchanger

Sr. No	Falling Film Chiller	Plate Heat Exchanger
1	Water Chilling down to temperature as low as 0.5 °C	Not suitable for low water temperature applications
2	FFC allows the operation with polluted liquid as well	Not suitable for polluted liquid applications
3	In case of ice building on plates, there is no damage to the plates	Plates get damaged during ice building
4	U value or efficiency of FFC remains the same	Due to scale deposition, the efficiency of PHE or U value decreases drastically. Needs frequent cleaning
5	Low or no maintenance and operating cost	Periodic maintenance which adds to operating costs
6	Design and operating parameters may vary based on load requirements	Design and operating parameters need to be the same for low temp application because any change in operating parameters may result in heavy losses or damage of PHE
7	Low affinity of soiling, easy to clean	
8	No Gaskets	Require time to the time change of gaskets
9	Flexibility of usage	Limitations of Usage

Demerits

- ❖ High upfront cost.
- ❖ Requires system modification.

Cost Benefit Analysis

The expected electricity savings to be achieved by installation of FFC is 5.04 lakh units annually. The annual monetary saving for this project is **INR 7.34 lakh, with an investment of INR 15.00 lakh, and a payback period of 24 months.**

Table 43: Cost Benefit Analysis – Falling Film Chiller

Parameters	UOM	Option 1 - CHW supply from existing IBT system	Option - 2 CHW supply from dedicated FF chiller
Actual CHW Temperature requirement °C	°C	1	1
CHW supply temperature °C	°C	Varying due to incoming fluctuations in process water return temp of 8°C -10°C	
Refrigeration load	TR	73	73
Power Consumption	kW	100	84

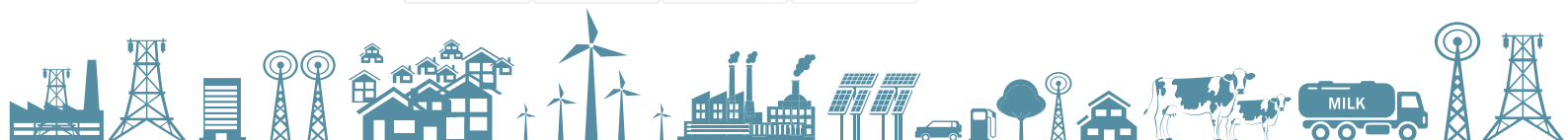

Parameters	UOM	Option 1 - CHW supply from existing IBT system	Option - 2 CHW supply from dedicated FF chiller
Specific power	kW/TR	1.37	1.15
Operating days/annum	days	300	300
Operating hrs/day	hrs	24	24
Annual energy consumption	kWh	7,20,000	5,97,000
Annual electricity saving	kWh		1,22,400
Power cost INR7.5/kWh	INR lakh	4.32	3.58
Annual cost saving	INR lakh		7.34
Investment	INR lakh		15.00
Payback	months		24
IRR	%		121.28
NPV at 70 % Debt (12% rate)	INR lakh		173.32

Energy & GHG Savings

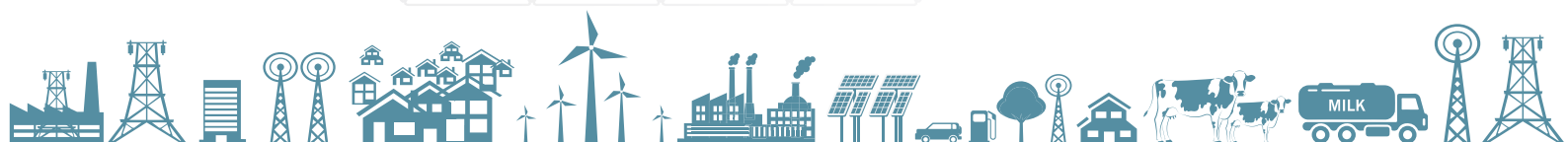

Reference Plant Implementation

Table 44: Reference Plant Implementation – Falling Film Chiller

Project Name	Installation of VFD for reciprocating chiller
Objective	Installation of falling film chiller before the IBT to prechill the process return water
Installation Photo	
Assumptions	<ul style="list-style-type: none"> ❖ Rated TR 100 TR ❖ Operating TR Vary between 60 to 100 Tr ❖ Electricity Cost – 8 INR/kWh ❖ Annual operating hours – 5,000 Hrs ❖ Compressor operating SEC – 1.25 kW/TR ❖ Process return water temperature - 12°C (before installation)
Savings (INR lakh)	₹ 9.50 lakh
Investment (INR lakh)	₹ 15.00 lakh
Simple Payback Period	20 months
Replication potential	In all the dairy units
Outcomes	<ul style="list-style-type: none"> ❖ Reduction in SEC of 0.25 to 0.30 kW/TR ❖ Annual electricity savings of 1,25,000 units ❖ Able to generate water at 10C continuously from IBT
Unit contact details	<p>Mr Lalit Gupta Arvind Dairy, Charra, Aligarh Phone: 9911103034 Email: arvinddairy Pvt.ltd@gmail.com</p>
Cluster Reference	Uttar Pradesh

Vendor Details

Table 45: Vendor Details – Falling Film Chiller

Equipment Detail	Falling Film Chiller
Supplier Name	Omega Ice Hill Pvt Ltd
Address	Omega Ice Hill Pvt Ltd 39, First Floor, Raghushree Market Near Ajmeri Gate, Delhi
Contact Person	Mr Abhishek Jindal
Mail Id	abhishek.jindal@omega-icehill.in

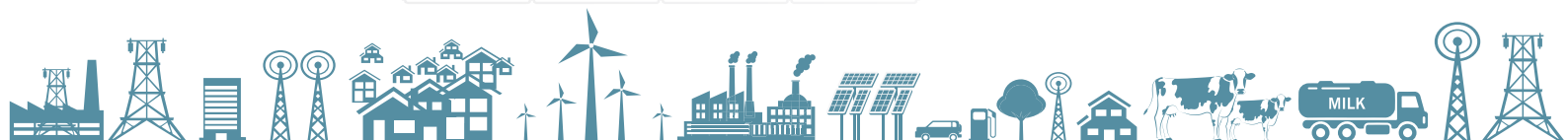

4.2.6 Direct Cooling Method – IBT

Baseline Scenario

A dairy unit in Pune has a milk processing facility. VATS cooling is maintained by conventional IBT tank provided with all civil constructed wall (except bottom side) thermal insulation. The top face of the tank is open and covered by wooden planks supported on MS angle fabricated support structure. IBT is basically a thermal storage system which is bulky in nature and utilizes old technology of ice bank with agitator.

IBT tank cooling source from Ammonia-based refrigeration plant 70 TR – (KC3 & MX 300), Ammonia evaporation on -10 to -15°C. Mechanical stirrers (agitator) are provided (one in each section of IBT tank) for creating forced circulation inside IBT tank for uniform cooling of water inside IBT Tank. IBT tank is used in refrigeration system for making ice during off peak hours and using this thermal stored energy during peak hours. The charging of the IBT tank is done almost 20 hrs to 24 hrs/day, depending on product quantity received and ambient conditions

Operating efficiency analysis (Existing loss study)

The energy consumption is much higher than the estimated required energy. The specific energy consumption in summer is about 50-60% more than that of winter. Condensing pressures are higher in summer, and hence, condensing temperatures are about 5°C higher in summer. Energy consumption is 10% higher for 5°C. Higher condensing ice bank systems have poor charging and discharging characteristics, which increases energy consumption. Stirrer adds to the energy consumed. The compressors operate much longer, especially in the summer. This also adds to cooling tower load and hence inefficient chiller operation.

In summer, recorded cooled product temperature was much higher as the system was not able to meet the cooling demand. It is estimated that it fell short by 20%. The Ice Bank system is not getting charged to an optimum level and not able to discharge when required. Theoretical energy consumption estimates are much lower than the actual consumption, hence there is a scope of incorporating Direct Cooling, using PHE Chiller System, to improve the performance of the system and to achieve better cooling throughout the year.

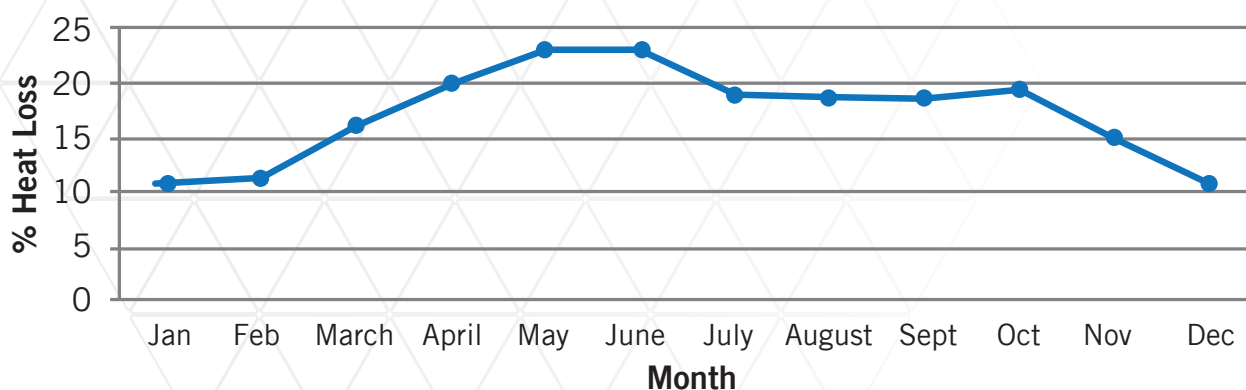
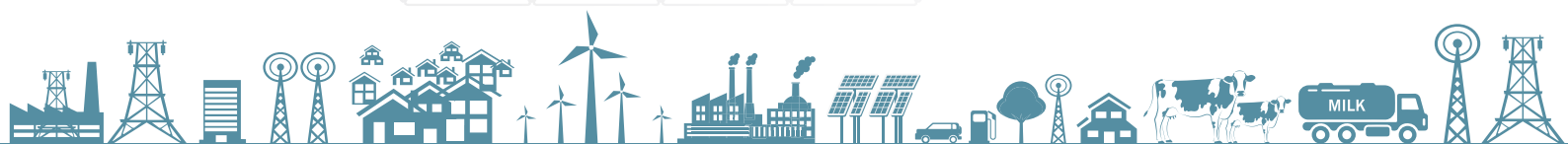

Figure 25: Typical operating efficiency analysis for different seasons



Proposed System

The proposed system is designed for direct cooling of the constant requirement of chilled water at process 1.0-1.5°C. Direct cooling PHE evaporator will have a primary and secondary circuit to avoid the freezing of process water. The new design direct cooling method Ammonia compressor with suction pressure of 2-2.5 kg/cm² to evaporative condenser can maintain the condensing temperature at 35°C. HPR will supply ammonia at 8-10 kg/cm² to PHE evaporator. PHE evaporator will have ammonia thermal expansion valve modulation based on chilled water supply temperature. The primary circuit of the PHE evaporator will transfer the cooling load at -0.3°C on the secondary side of the PHE chiller. Process chilled water (4-5°C) will be in continuous circulation with the help of low-temperature pumps. To cater to the load requirement of process 1.0-1.5°C, the process return water will be fed through the secondary side of the PHE evaporator, which will have a temperature controller along with the 3-way valve to maintain the output temp of 1.0 – 1.5°C.

Merits

- ❖ Low energy consumption at ammonia compressor due to higher suction pressure.
- ❖ The closed-looped system, no cooling loss or addition of external heat from ambient.
- ❖ Capacity augmentation – existing installed refrigeration plant will be able to cater to higher production.

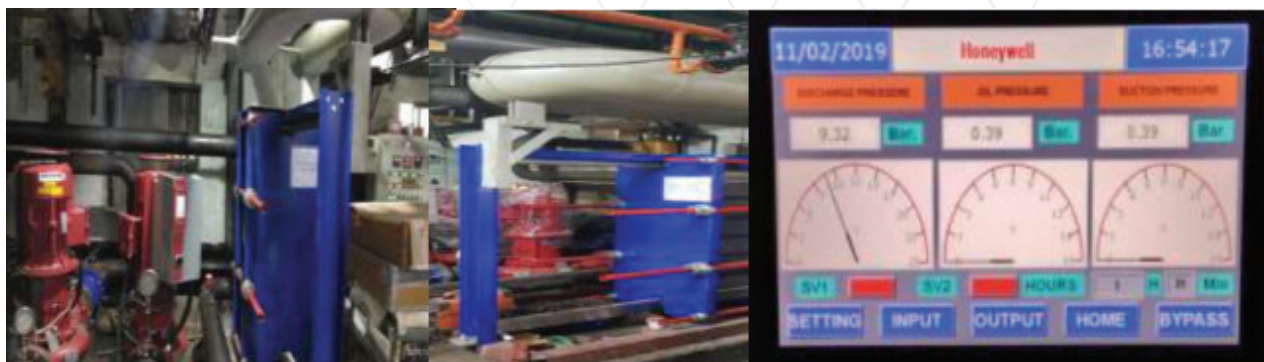

Figure 26: Post Implementation – Direct Cooling Method

Limitations

- ❖ Automation required on the existing system.
- ❖ Estimation of proper cooling load.
- ❖ Minimum cooling load required to maintain stable suction pressure.

Cost Benefit Analysis

The estimated electrical savings to be achieved by installation of direct cooling method of 3.20 Lakh units per annum. **The annual monetary saving for this project is INR 27 lakh, with an investment of INR 70 lakh, and a payback period of 30 months.**

Table 46: Cost Benefit Analysis – Direct Cooling in IBT

Parameters	UOM	Value
Existing refrigeration plant capacity	TR	70
Suction pressure	kg/cm ²	1 – 0.8
Ammonia evaporation temp	°C	-15
IBT Supply temp	°C	1.0 -1.5
Sp. Energy consumption	kW/TR	1.11
Existing Electrical energy consumption	kWh/month	89,385
Addition of new refrigeration capacity	TR	100
Total TR	TR	170
New suction pressure	kg/cm ²	2.5
Ammonia Evaporation temp	°C	-5
Sp. Energy consumption	kW/TR	0.8
IBT supply temp	°C	1
New electrical consumption with additional capacity	kWh/month	62,517
Total units saved	kWh/month	26,868
Annual electrical savings	kWh	3,22,000
Monetary savings	INR lakh	27.0
Investment	INR lakh	70.0
Payback	months	31
IRR	%	56.63
NPV at 70% Debt (12% rate)	INR lakh	104.77

Energy & GHG Savings

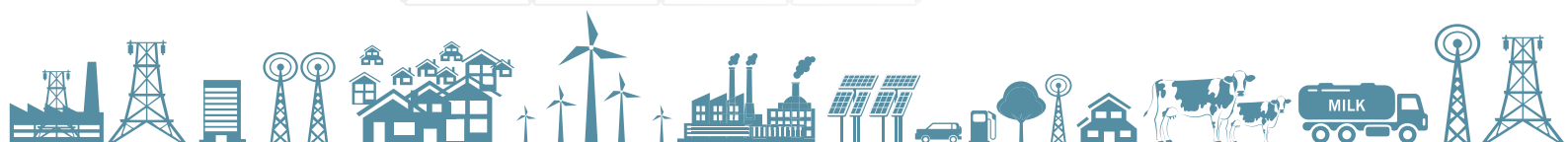

Vendor Details

Table 47: Vendor details – Direct Cooling in IBT

Equipment Detail	Direct Cooling Method
Supplier Name	Honeywell Automation – Energy services
Address	56 & 57, Hadapsar Industrial Estate, Pune
Contact Person	Hari Mohan Singh
Mail Id	hari.singh@honeywell.com
Phone No	9011186665

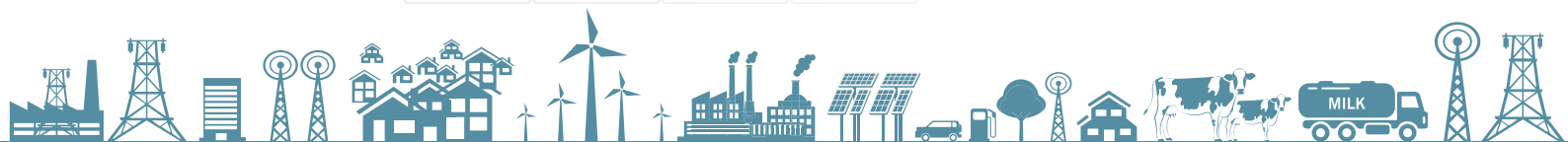

4.2.7 Double effect steam driven vapour absorption chiller heater

Baseline Scenario

The unit has installed 3 nos. of 33 TR chiller with reciprocating compressors for refrigeration requirement in the plant. The plant team already has a briquette fired boiler of 2 Ton capacity.

Conventionally dairies use chiller and boiler for cooling and heating requirement. A chiller being used to generate refrigeration uses high grade heat. Similarly, for generating hot water, fossil fuel fired (like briquette, oil, etc.) hot water generators are used. Else, Steam is used to heat water, which again is from a fossil fuel fired boiler. Thus, for producing ~90°C hot water, flue gases produced by combustion of fuels at 1000°C are used, i.e. high-grade heat is used to produce low temperature hot water.

The reciprocating chiller compressors consumed around 1.37 kW/TR. As the reciprocating compressor ages the specific energy consumption of the reciprocating chillers increases, due to wear and tear and maintenance of the compressor such as reboring and overhauling. During plant operation 2 chillers are in operation and one chiller is kept in stand by condition.

Proposed System

It is recommended to install a 65 TR double effect VAM based refrigeration system in comparison to an electrical chiller-based refrigeration system. Current electrical chilling system of 33 TR x 3 nos was replaced with VAM chilling system. Since the boiler had further margin to provide additional steam for VAM, new boiler was not procured by the plant team. The plant is utilizing briquette as fuel in the boiler. Briquette is a cheaper fuel and has a good advantage of producing steam at low cost. The plant was producing 8.5 kg/cm² from the boiler. The excess margin of steam available in the boiler was utilized for VAM.

In high efficiency chiller Heater 40% of Heat required for generating hot water is recovered from low temperature chilled water. Remaining 60% is recovered from external heat source. Thereby, 40% reduction in direct external heat source can be achieved for heating hot water as compared to conventional hot water generator. Additionally, refrigeration is also generated simultaneously. Cost incurred for Piping, insulation, electrical equipment and safety controls required in conventional system is higher than that of a Chiller-Heater. This high efficiency Chiller heater is compact in size and requires less space than conventional system.

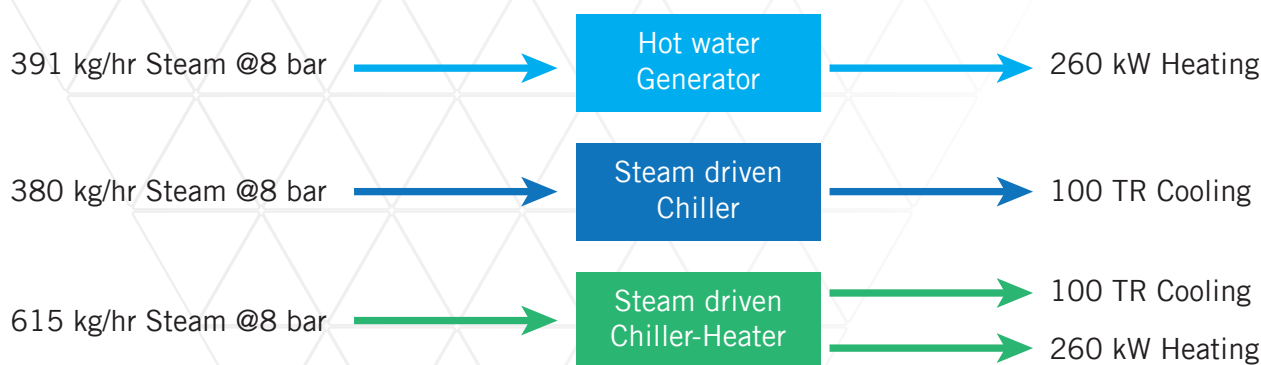
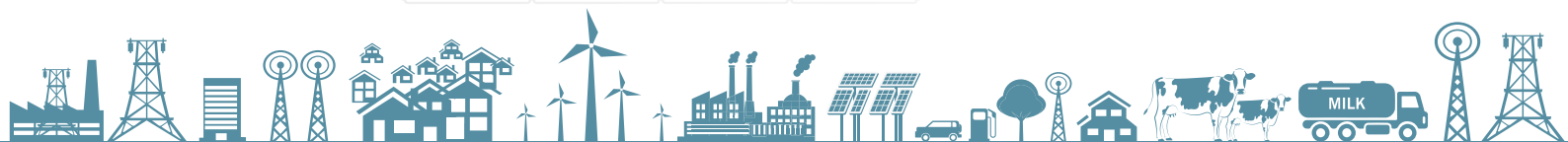

Figure 27: Comparison over conventional system



VAM comes with two stage evaporation technology which ensures the lowest specific steam consumption as compared to other contemporary VAMs making them the most efficient VAM in their category. The specific steam consumption is as low as 3.5 kg/TR/hr for small to medium capacity range and a separate high COP range for larger capacities. This results in:

- ❖ Lowest cost of ownership of the VAM
- ❖ Lowest water consumption in cooling tower resulting in savings of the precious water

Basic principle of operation

Vapour Absorption Machine uses water as the refrigerant and LiBr solution as the absorbent. The process of cooling goes through stages such as evaporation of refrigerant in evaporator, absorption of refrigerant by concentrated LiBr solution in absorber, boiling of dilute LiBr solution to generate refrigerant vapour in generator and condensation of refrigerant vapour in condenser. The boiling point of water is directly proportional to pressure. At 6mmHg absolute pressure the boiling point of water is 3.7°C. To change water from liquid to vapour it must be heated. The heat, required to change the phase of a liquid to vapour, is called the Latent heat of evaporation.

Lithium Bromide (LiBr) is a chemical like common salt (NaCl). LiBr is soluble in water. The LiBr water solution has a property to absorb water due to its chemical affinity. As the concentration of LiBr solution increases, its affinity towards water vapour increases. Also as the temperature of LiBr solution decreases, its affinity to water vapour increases. Further, there is a large difference between vapour pressure of LiBr and water. This means that if we heat the LiBr water solution, the water will vaporise but the LiBr will stay in the solution and become concentrated.

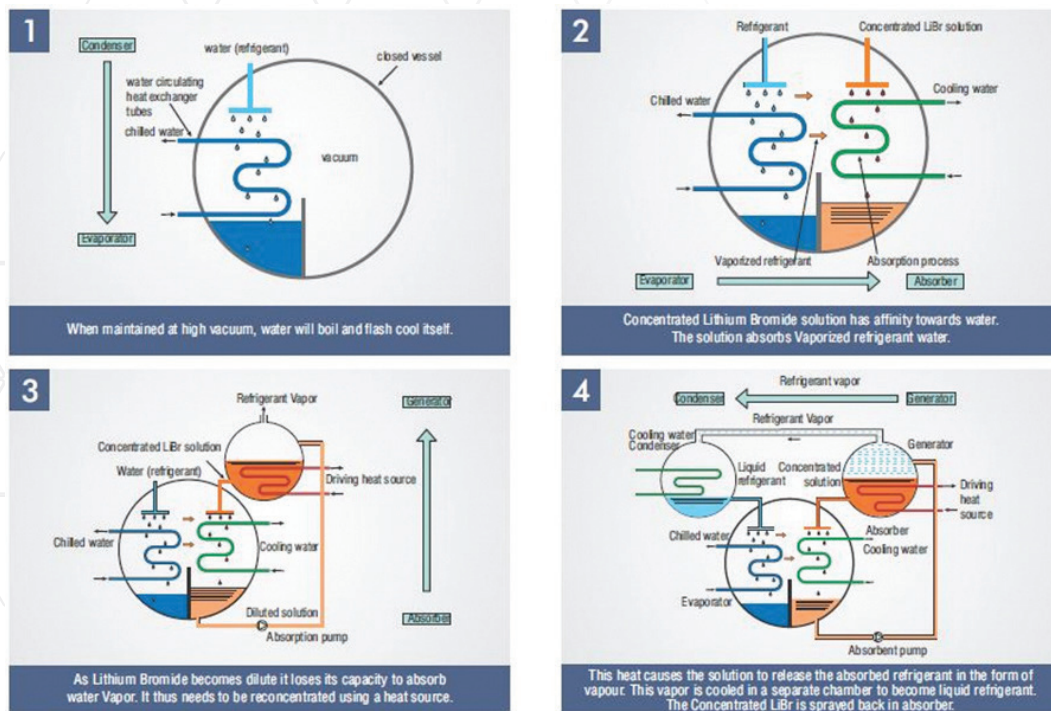
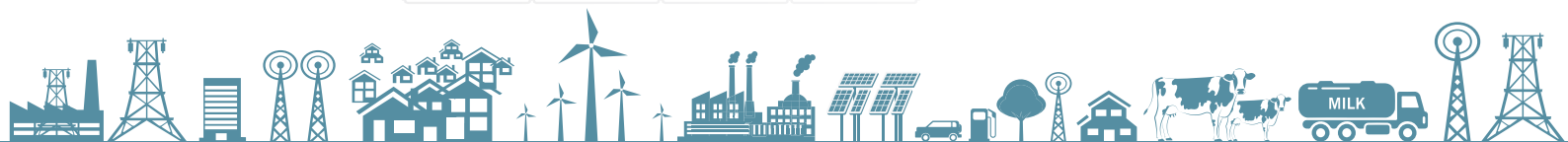

Figure 28: VAM working



Technical Specification

Table 48: Technical specification of VAM

DESCRIPTION	UNITS	VALUE
Cooling Capacity ($\pm 3\%$)	TR	65
	kW	229
Heating Capacity (Through Sidearm) ($\pm 3\%$)	kW	56.5
A CHILLED WATER CIRCUIT:		
1. Chilled Water Inlet Temperature	$^{\circ}\text{C}$	4.0
2. Chilled Water Outlet Temperature	$^{\circ}\text{C}$	1.0
3. Chilled Water Flow Rate	m^3/hr	65.1
4. Passes in Evaporator	Nos.	2+2
5. Chilled Water Circuit Friction Loss	m LC	10.1
6. Glycol in Chilled Water		NA
7. Concentration of Glycol	%	0
8. Fouling Factor	$\text{m}^2\text{hr}^{\circ}\text{C}/\text{kCal}$	Standard
9. Connection Diameter (Indicative)	mm	125.0
10. Maximum Working Pressure	Kg/cm^2 (g)	8.0
B HOT WATER CIRCUIT (THROUGH SIDEARM):		
1. Hot Water Inlet Temperature	$^{\circ}\text{C}$	85.0
2. Hot Water Outlet Temperature	$^{\circ}\text{C}$	90.0
3. Hot Water Flow Rate	m^3/hr	10.0
4. Hot Water Circuit Friction Loss	m LC	5.4
5. Glycol in Hot Water		NA
6. Concentration of Glycol	%	0
7. Fouling Factor	$\text{m}^2\text{hr}^{\circ}\text{C}/\text{kCal}$	Standard
8. Maximum Working Pressure	kg/cm^2 (g)	8.0
C COOLING WATER CIRCUIT:		
1. Cooling Water Inlet Temperature	$^{\circ}\text{C}$	30.0
2. Cooling Water Outlet Temperature	$^{\circ}\text{C}$	34.4
3. Cooling Water Flow Rate	m^3/hr	80.0
4. Cooling Water Outlet Temperature-SIM mode	$^{\circ}\text{C}$	34.2

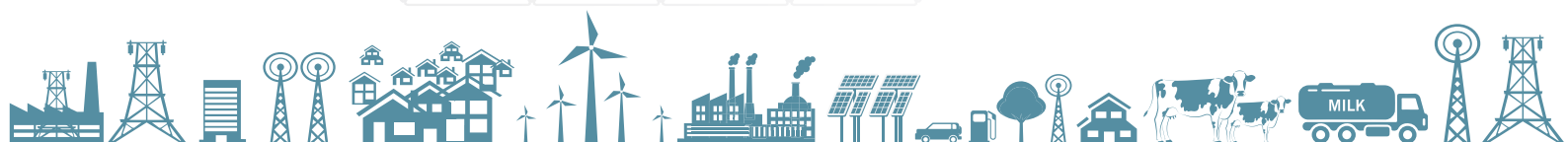

	DESCRIPTION	UNITS	VALUE
5.	Cooling Water Bypass Flow	m ³ /hr	0
6.	Passes in Absorber / Condenser	Nos.	1+1/1
7.	Cooling Water Circuit Friction Loss	m LC	2.7
8.	Glycol in Cooling Water		NA
9.	Concentration of Glycol	%	0
10.	Fouling Factor	m ² hr°C/kCal	Standard
11.	Connection Diameter (Indicative)	mm	150.0
12.	Maximum Working Pressure	kg/cm ² (g)	8.0
D STEAM CIRCUIT:			
1.	Steam Type		Dry Saturated
2.	Steam Pressure	kg/cm ² (g)	8.0
3.	Steam Consumption for Full capacity (±3%)	kg/hr	270.3
4.	Steam Consumption for Full capacity - SIM Mode (±3%)	kg/hr	325.6
5.	Drain Outlet Temperature	°C	80 - 100
6.	Condensate Drain Pressure	kg/cm ² (g)	1.0
7.	Steam Inlet Connection Diameter (Indicative)	mm	50.0
8.	Drain Connection Diameter (Indicative)	mm	25.0
E ELECTRICAL DATA:			
1.	Power Supply (3 Phase + N)	V, Hz	415 (±10%) 50 (±5%)
2.	Absorbent pump	kW(A)	2.2 (6.0)
3.	Refrigerant pump	kW(A)	0.3 (1.4)
4.	Vacuum pump	kW(A)	0.75 (1.8)
5.	Power consumption	kVA	7.6
F PHYSICAL DATA (APPROXIMATE, ±10%):			
1.	Length	m	3.9
2.	Width	m	2.0
3.	Height	m	3.2
4.	Dry Weight	Ton	5.7
5.	Operating Weight	Ton	6.9

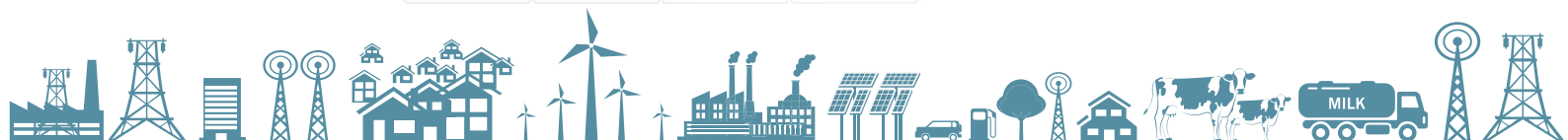

	DESCRIPTION	UNITS	VALUE
G	TUBE METALLURGY:		
1.	Evaporator		SS316L ERW
2.	Absorber		Copper
3.	Condenser		Copper

Cost Benefit Analysis

The annual monetary saving by installation of VAM is for this project is **INR 11 lakh, with an investment of INR 36.75 lakh, and a payback period of 40 months.**

Table 49: Cost Benefit Analysis – Vapour absorption machine

Parameters	UOM	Electrical Chilling	Vapour absorption machines
Cost of Electricity	INR /kWh	6.0	6.0
Steam Cost	INR/kg	1.4	1.4
SEC of chiller	kW/TR	1.37	
Coefficient of performance	No unit	2.97	1.2
Total TR requirement	TR	65	65
Heating requirement	kJ/hr	203300	203300
Steam consumption for chilling	kg/hr	-	270.3
Steam consumption for chilling	kg/hr	110	55
Electrical power consumption	kW	89.05	3.25
Total steam consumption	kg/hr	110	326
Cost of steam	INR/hr	154	456
Cost of electricity	INR/hr	534.3	19.5
Total cost of operation	INR/hr	688	475
Annual Operating hrs	hrs	5000	5000
Annual cost savings with VAM	INR lakh		10.65
Investment required for 66 TR VAM	INR lakh		36.75
Payback period	months		40
IRR	%		43.91
NPV at 70% Debt (12% rate)	INR lakh		37.15

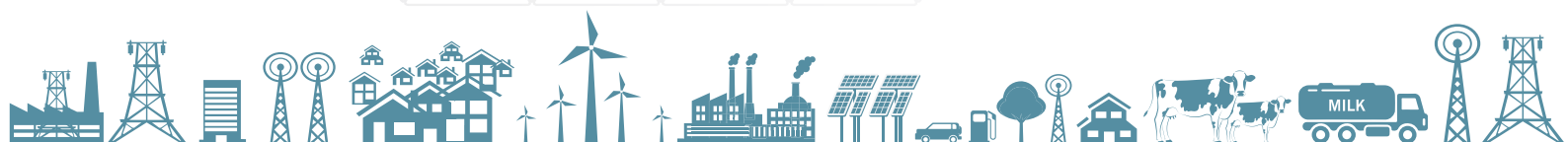

Energy & GHG Savings



Vendor Details

Table 50: Vendor Details - VAM

Equipment Detail	VAM
Supplier Name	Thermax Ltd
Address	Absorption Cooling Division-Bengaluru
Contact Person	Jevin John
Mail Id	jevin.john@thermaxglobal.com
Phone No	+91 7873436073

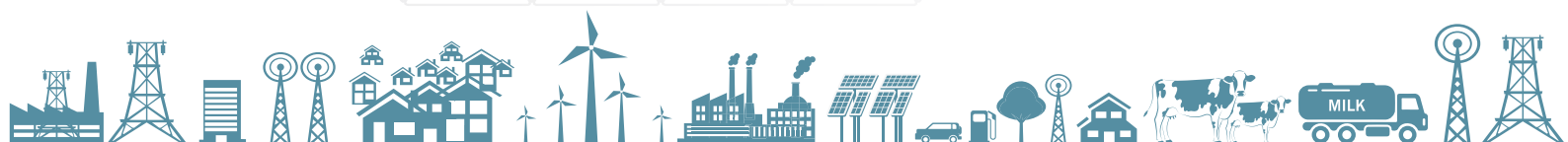

4.2.8 Desuperheater for Chiller Compressors

Baseline Scenario

The unit has installed two reciprocating chillers of 33 TR capacity for the chilling requirement in the plant. One compressor runs continuously, and second compressor runs based on load requirement. For the refrigeration purpose, vapor compression-based ammonia cycle is used. In a refrigeration cycle, when the compressor runs, the refrigerant starts flowing through the system. The compressor continuously sucks low pressure, low temperature refrigerant vapors from the evaporator and pumps it to the condenser at a high pressure and temperature.

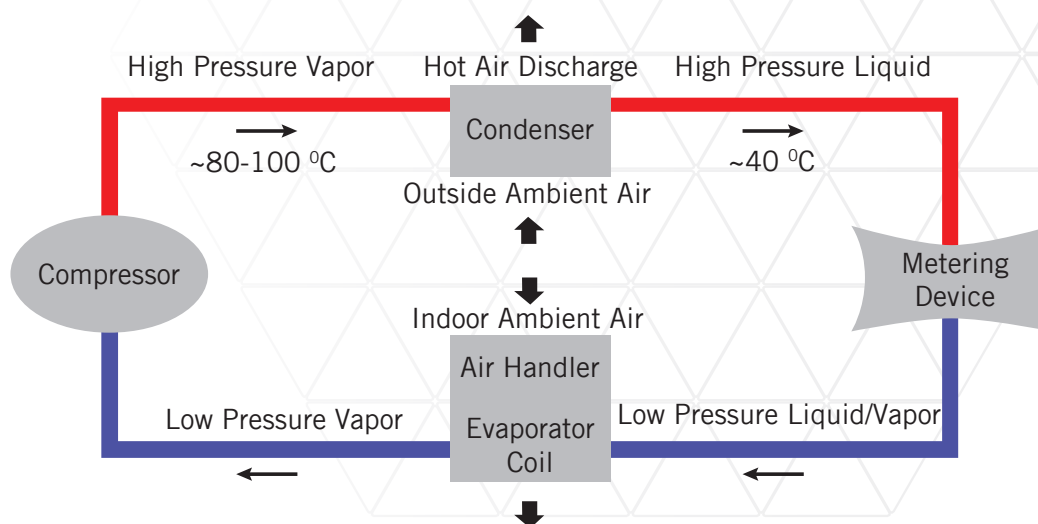
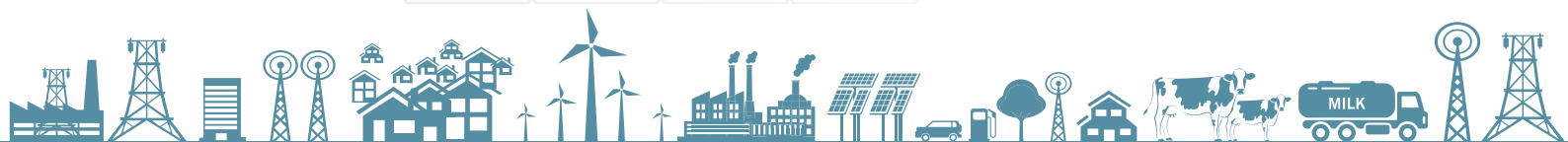

Figure 29: Vapour Compression Cycle

While flowing through the condenser, the high temperature vapors release their heat to the atmosphere and condense to a high-pressure liquid state. After condenser, this high-pressure liquid enters the expansion valve where it is throttled to a low pressure. On throttling, the pressure and temperature of the refrigerant decrease, and when this low pressure, low temperature throttled liquid flows through the evaporator, it sucks heat and produces cooling. On absorbing heat in the evaporator, all the low-pressure liquid evaporates to low-pressure, low-temperature vapors, which are again sucked by the compressor. In this way, all these processes go on continuously and if the compressor runs, the system produces cooling around the evaporator.

Refrigeration plants with air-cooled and water-cooled condensers produce a lot of waste energy by dumping the condensation energy to the ambient air. By installing a de-superheater, a large proportion of this waste energy can be turned into hot water, which can be used for many applications such as:

- ❖ CIP
- ❖ Boiler feedwater heating
- ❖ Process heating for processes like curd and Ghee preparation
- ❖ Crate washing and can washing in chilling centers



Proposed System

It is recommended to install Desuperheater on discharge side of chiller compressors to recover the waste heat of ammonia gas. The temperature of NH_3 gas will be around 100°C , which can be cooled to 60°C , and the recovered heat can be used for heating water from ambient to 70°C . The design should ensure that adequate heat is recovered with the required temperature lift. Apart from the direct energy saving after getting hot water, the heat load on condenser is expected to come down, and if the design is done appropriately, the condensing pressures can also marginally reduce, leading to reduction in power consumption of compressors. Desuperheater units are located between the compressor and condenser to utilize the high-temperature energy of the superheated refrigerant gas. By using a separate heat exchanger to utilize the high temperature of the discharge gas, it is possible to heat water to a higher temperature than would be possible in a condenser. Key technical parameters for the heat recovery system are given below:

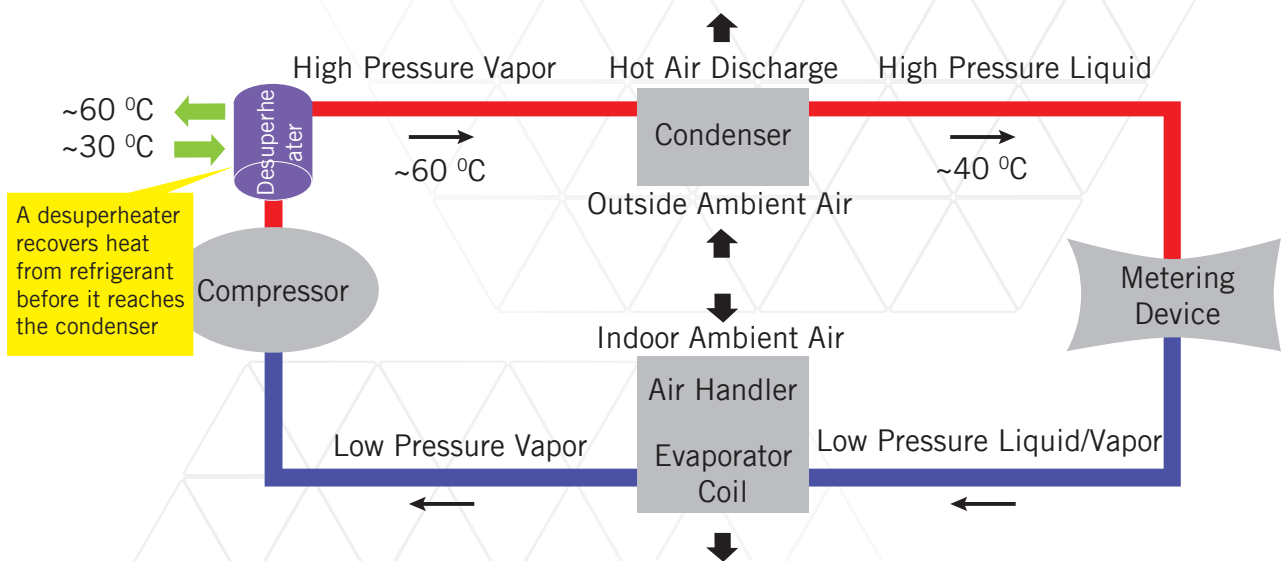
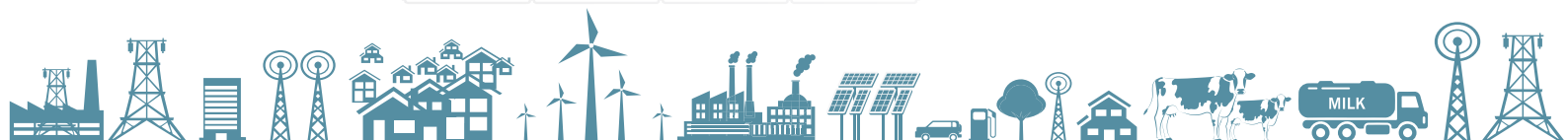

Figure 30: WHR from chiller compressor

Table 51: Key technical parameters of Desuperheater

Item	Value
Temperature of ammonia gas in/out	$100^\circ\text{C}/60^\circ\text{C}$
Temperature of water in/out	$30^\circ\text{C}/70^\circ\text{C}$
Amount of water that can be heated	294 litre/hr
Heat load recovered ¹	16.4 kW

¹ For 15kW of refrigeration load 6 kW heat recovery possible



Cost Benefit Analysis

The expected fuel savings to be achieved by installation of de-superheater is 0.25 Lakh kg of briquette annually. The annual monetary saving for this project is **INR 1.73 lakh, with an investment of INR 4.84 lakh, and a payback period of 34 months.**

Table 52: Cost Benefit Analysis – Installation of Desuperheater

Parameters	UOM	
Size of compressor	kW	41
Heat Recovery possible	kW	16.4
Heat Recovery possible	kJ/hr	59,011
Amount of hot water available for process (from 30 to 70°C)	litre per hour of water at 70°C	294
Hours of operation	hours per day	15
Days of operation	days per year	365
Cost of Briquette	INR/kg	6.7
Calorific value	kJ/kg	77,023
Boiler efficiency	%	68%
Fuel Savings	kg/year	25,809
Annual Cost Savings	INR lakh	1.73
Investment	INR lakh	4.84
Pay Back	months	34
IRR	%	52.98
NPV at 70% Debt (12% rate)	INR lakh	6.55

Energy & GHG Savings

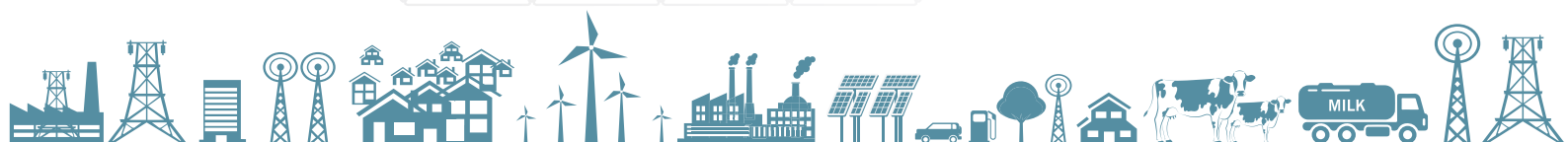

Reference Plant Implementation

Table 53: Reference Plant Implementation - De-superheater

Project Name	Installation of De-Superheater
Objective	Installation of de-superheater to preheat boiler feed water from the superheated refrigerant gas.
Dairy profile	Ernakulam Dairy, a unit under Ernakulam Regional Co-operative Milk Producers' Unions (ERCMPU) of MILMA, has its plant at Thrippunithura, Ernakulam, Kerala, and offers pasteurized Vitamin A-enriched milk and various milk-based products, such as butter, curd, ghee and Sambharam throughout the State.
Installation Photo	
Assumptions	<ul style="list-style-type: none"> ❖ Fuel Cost – INR 7/kg ❖ GCV – 18,409 kJ/kg ❖ Annual operating hrs - 5475 ❖ Feed water temperature – 30°C ❖ Boiler efficiency – 0.70
Savings (INR lakh)	₹ 5.08 lakh
Investment (INR lakh)	₹ 16 lakh
Simple Payback Period	36 months
Replication potential	In all the dairy units, BMC and MCCs irrespective of size
Outcomes	<ul style="list-style-type: none"> ❖ 13.27 kg/hr of briquette saved ❖ Temperature of hot water achieved – 60°C ❖ 30.50 TOE of annual energy savings ❖ Increase in feed water temperature
Unit contact details	<p>Mr. Babu Varghese Milma Ernakulam Dairy Thrippunithura P.O. Ernakulam – 682101, Kerala Phone: 0484-2780103 Email: ernakulamdairy@yahoo.co.in</p>
Cluster Reference	Madhya Pradesh Cluster

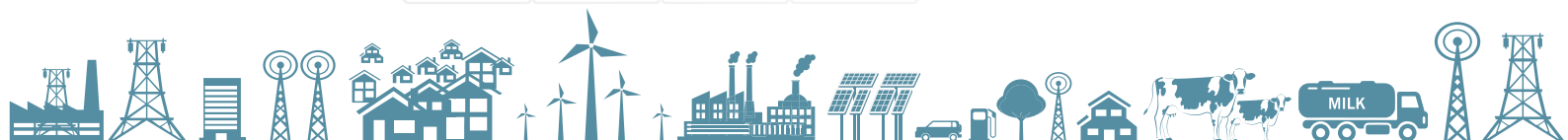

Vendor Details

Table 54: Vendor details – De-superheater for Compressors

Equipment Detail	Desuperheater
Supplier Name	Promethean Energy Pvt Ltd
Address	Akshar Blue Chip IT Park, Turbhe MIDC, Turbhe, Navi Mumbai : 400706
Contact Person	Mr. Ashwin KP
Mail Id	ashwinkp@prometheanenergy.com
Phone No	+91 9167516848

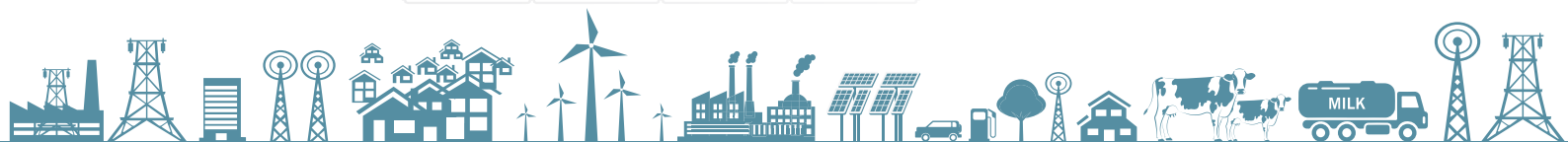

4.2.9 kVAr Energy Compensator for Chiller Compressor

Baseline Scenario

The unit has installed three reciprocating chiller compressors of 60 TR capacity each for the chilled water requirement in the plant. During normal operation two compressors are running continuously and third compressor runs based on demand. The table below shows the electrical parameters of chiller compressor:

Table 55: Electrical parameters

Compressor Name	Volt	Current	Power	PF
Chiller Compressor 1	407	119	73.1	0.87
Chiller Compressor 2	408	121	74	0.85

Both the compressors are running without VFD and operating at a PF of 0.86. The unit has installed a capacitor bank at the source for the central compensation of PF at the plant level. For induction motor to operate it requires reactive current from the source for producing the magnetization effect. More the reactive current drawn from the supply higher will be the distribution losses across the feeder. It is always better to provide the reactive current locally to reduce the distribution losses in the plant.

Proposed System

It is recommended to install a reactive current injector locally near to the load end to reduce the reactive current drawn from the supply. An innovative product called kVAr compensator can be installed near to load end to improve the PF of motor and thereby reduce the magnetization current drawn from supply. The kVAr compensator works by reclaiming, storing and then supplying locally the reactive power element of electricity to inductive motors and loads. As the electrical equipment operates, this reactive power is 'pulled and pushed' to and from the kVAr compensator by the motor. Reactive power is then recycled by the kVAr compensator which can supply it on the spot without having to draw it from the grid. This leads to reduction in electric demand and improvement in the power factor and thus, the operating costs.

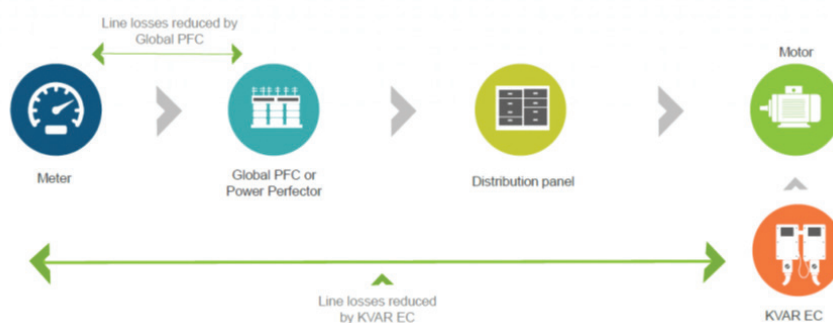

Figure 31: kVAr energy compensator

From a technical point of view this is the best solution, as the reactive energy is produced at the point where it is consumed. Heat distribution losses (I_2R) are therefore reduced in all the lines, resulting in real power reduction. The kVAr required for the motor to maintain the PF close to unity is found out by using a sizing kit. It helps in fixing and selecting the correct size of kVAr unit required to make the inductive load work in most efficient way.

Merits

- ❖ Reduce distribution losses across the infrastructure that translates into cost savings
- ❖ Reduce kW Demand charge the motor draws and frees capacity in the electric distribution system up extra space in supply panel
- ❖ Improve voltage regulation and phase imbalance due to reduced voltage drop
- ❖ Reduce operating cost of machinery
- ❖ Improve Power Factor of an Induction Motor
- ❖ Works on all line-start and soft-start inductive loads such as motors, compressors, pumps, chillers, fans, blowers, etc.
- ❖ Customized unit built for each load after real-time monitoring and testing procedures.

Demerits

- ❖ It's not suitable for chillers with VFD.

Cost Benefit Analysis

The expected electricity savings to be achieved by installation of kVAr compensator is 46,570 units annually. The annual monetary saving for this project is **INR 2.56 lakh, with an investment of INR 4.20 lakh, and a payback period of 20 months.**

Table 56: Cost Benefit Analysis – kVAr Energy Compensator

Parameters	UOM	Value
Total power consumption of chiller	kW	147
Guaranteed power savings	%	4
Power savings	kW	5.88
Operating hrs	hrs	24
Operating days	Days	330
Electricity Price	INR/kWh	6.00
Annual electricity savings	kWh	46,570
Annual cost savings	INR lakh	2.56
Investment	INR lakh	4.20
Pay Back	months	20

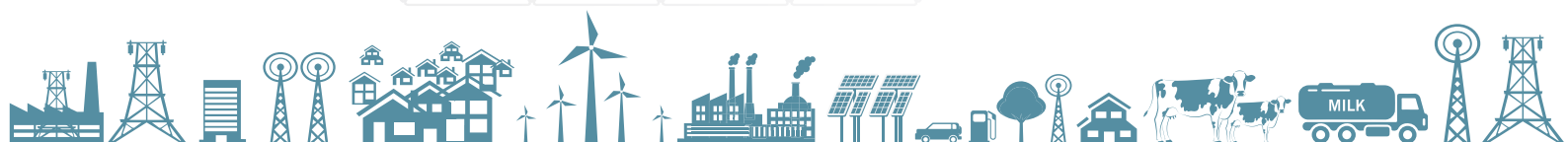

Parameters	UOM	Value
IRR	%	83.57
NPV at 70 % Debt (12% rate)	INR lakh	11.06

Energy & GHG Savings



Reference Plant Implementation

Table 57: Reference Plant Implementation – kVAr Compensator

Project Name	Installation of kVAr Compensator
Objective	Installation of kVAr compensator to reduce the energy losses.
Installation Photo	
Assumptions	<ul style="list-style-type: none"> ❖ Electricity Cost – INR 6.65 /kWh ❖ Operating hrs – 20 hrs/day
Savings (INR lakh)	₹ 1.22
Investment (INR lakh)	₹ 1.01
Simple Payback Period	10 months
Replication potential	In all the dairy units having chiller compressor without VFD
Outcomes	<ul style="list-style-type: none"> ❖ Annual electricity savings – 18,496 ❖ Improvement in PF
Unit contact details	Mr. D. Manikyala Rao, Neuland Labs Ltd.
Cluster Reference	Hyderabad Pharma Cluster

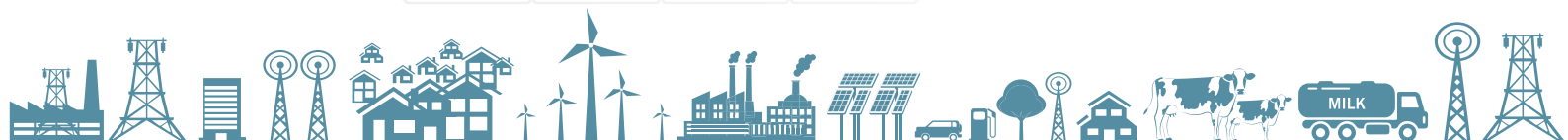

Vendor Details

Table 58: Vendor Details – kVAR Energy Compensator

Equipment Detail	kVAR Energy Compensator
Supplier Name	Athena CleanTech
Address	1904, Haware Infotech Park, Sector 30A, Vashi, Navi Mumbai
Contact Person	Mr. Sanjeev Reddy
Mail Id	sanjeev@cleantech.com.sg
Phone No	+91 9440259863.

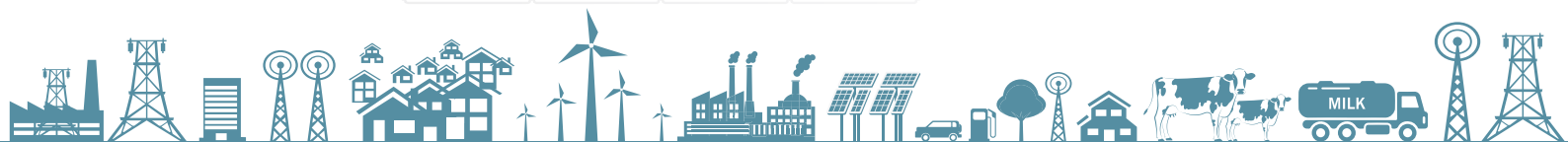

4.2.10 VFD for chilled water pumps

Baseline Scenario

The dairy unit in Maharashtra has installed four chilled water pumps of 10 HP each for pumping chilled water from IBT to process. During normal operation, three pumps are in operation. The flow requirement to different processes varies in the range of 1,000 to 2,500 LPH. The chilled water is used in different processes viz. milk chiller, ice cream & buttermilk processing, ACs, etc. The IBT is maintained at 0.1 to 0.5°C. After the process, the return water is coming at 6°C to 8°C. The figure below shows the schematic of a chilled water system in the plant. The total discharge line from the pumping system is 180 mm dia over a required length up to 500 m, and hence the line losses are not so high. The existing layout is shown below:

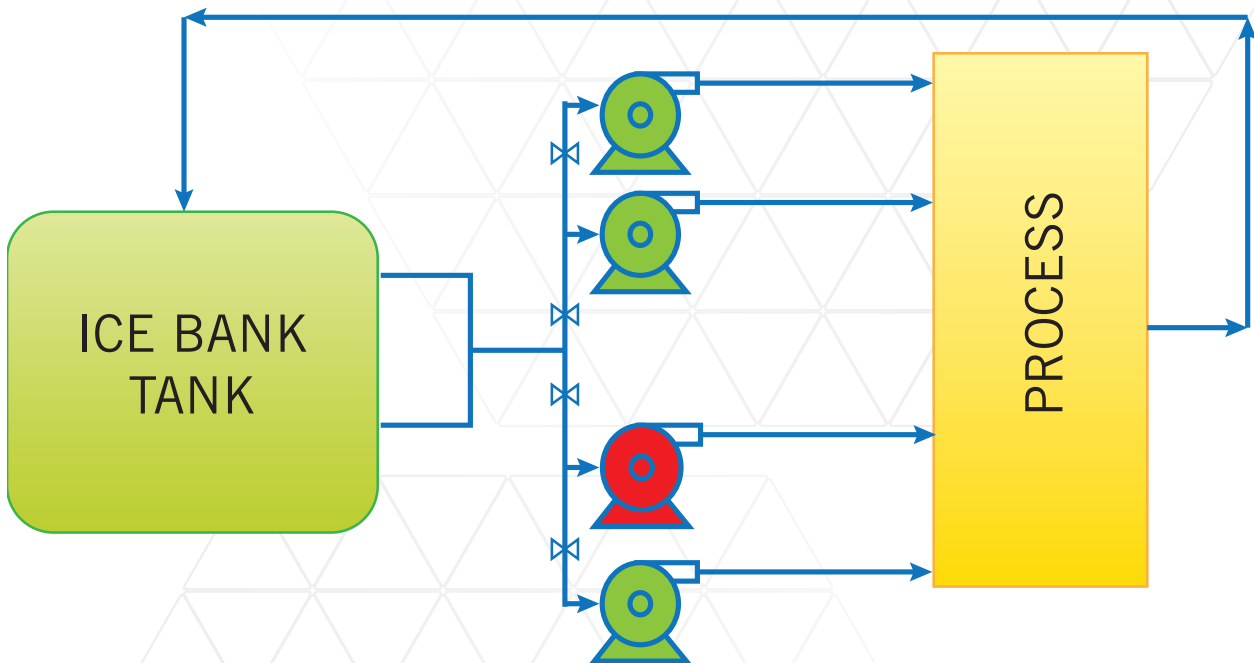

Figure 32: Existing pumping layout

The current operating practice in the plant is to operate the pumps such that the discharge pressure of 2 kg/cm² is available & the maximum flow of 2500 LPM is maintained. For these required conditions, one pump operates at its full load operating conditions & the other two pumps are manually controlled for the required pressure & flow conditions.

Proposed System

The best possible solution for this condition is to install VFD in one of the pumps and operate the other two pumps in fully open conditions. The required system pressure will be given as feedback to the VFD based on which the required flow can be obtained. The overall savings here will be in terms of higher operating efficiency of one pump and lower RPM for the operation of the third pump.

The pump with VFD will also ensure minimum recirculation under conditions when the system is under no-load condition.

Merits

- ❖ Higher operating efficiencies
- ❖ Reduced power consumption
- ❖ Optimum flow & head

Limitations

- ❖ Higher installation costs
- ❖ May require system stoppage during installation

Cost Benefit Analysis

The expected electricity savings to be achieved by installation of VFD for chilled water pump is 24,000 units annually. The annual monetary saving for this project is **INR 0.96 lakh, with an investment of INR 0.50 lakh, and a payback period of 06 months.**

Table 59: Cost Benefit Analysis – VFD for chilled water pump

Parameters	UOM	Present	Proposed
Power Consumption	kW	22	18
Flow	LPM	1000 - 2500	1000 – 2500
Head	m	30	25
Overall Efficiency	%	65	72
Power Savings	kW		4
Electricity Cost	INR/kWh		4
Operating hrs	hrs/day		20
Energy Savings	kWh		24000
Cost Savings	INR lakhs		0.96
Investment	INR lakhs		0.50
Pay Back	Months		6
IRR	%		4.64
NPV at 70 % Debt	INR Lakh		222.60

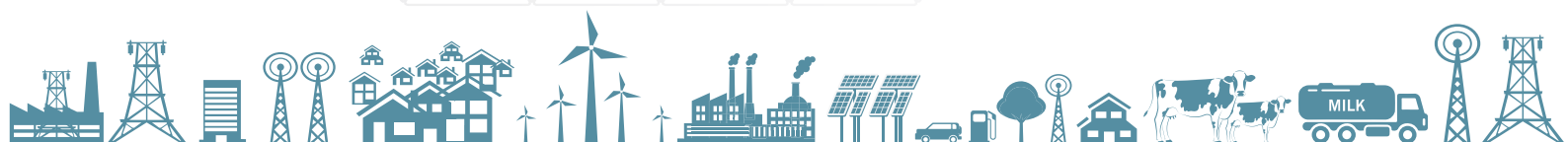

Energy & GHG Savings



Reference Plant Implementation

Table 60: Reference Plant Implementation – VFD for chilled water pump

Project Name	VFD for chilled water pump
Objective	Replaced old system for chilled water circulation contains one 10 hp pump and one 15 hp pump by new VFD controlled pumping system in which one 7.5 hp pump is directly coupled with VFD and other four more pumps of 7.5 hp each used to get the required rate of flow.
Unit Profile	Kozhikode Dairy under MRCMPU Ltd has an average daily procurement of raw milk-6 Lakh L and with an average daily sale of processed milk-5Lakh L . Other products- Curd, Ghee, Peda, Butter, Butter milk, Ice cream, Palada, Burfi etc
Installation Photo	
Assumptions	<ul style="list-style-type: none"> ❖ Electricity Cost – INR 5.50 /kWh ❖ Operating hrs – 20 hrs/day
Savings (INR lakh)	₹ 2.45 lakh
Investment (INR lakh)	₹ 19.42 lakh
Simple Payback Period	97 months
Replication potential	In all the dairy units
Outcomes	<ul style="list-style-type: none"> ❖ Annual electricity savings – 44,712 ❖ Smooth control of pumps
Unit contact details	Mr. Shaji Mon Dairy Manager Kozhikode Dairy, MRCMPU region Mail Id: kkddairy@malabarmilma.coop Phone No: 04952800331
Cluster Reference	Madhya Pradesh Cluster

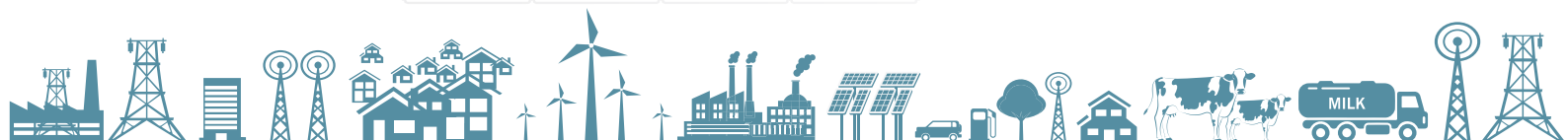

Vendor Details

Table 61: Vendor Details – VFD for chilled water pump

Equipment Detail	VFD for chilled water pump
Supplier Name	Danfoss Industries Ltd
Address	703,7th Floor, Kaivanya Complex, Near Panchwati Cross Road, Ambawadi, Ahmedabad
Contact Person	Mr. Srihari Vyas
Mail Id	Shrihari@danfoss.com

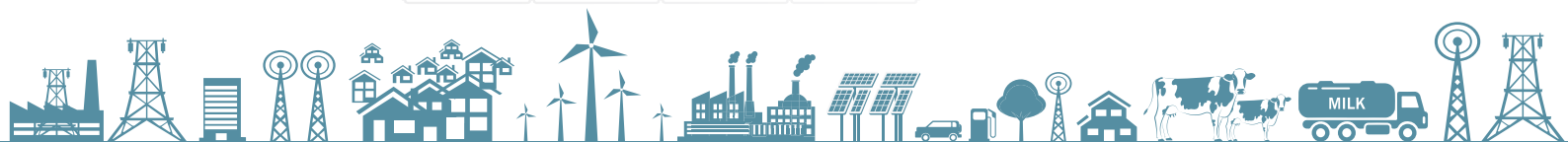

4.3 Case Studies – Bulk Milk Cooler

4.3.1 Thermal Energy Storage for BMC

Baseline Scenario

Milk is one of the most nourishing foods in the world. Milk contains numerous nutrients and makes a significant contribution to meeting the human body’s needs for calcium, riboflavin, magnesium, selenium, vitamin B12 and pantothenic acid (vitamin B5). It is also one of the few consistent income sources for farmers. However, as soon as milk leaves the udder of the mammal, the bacteria in it start multiplying exponentially, which deteriorates the quality of milk by converting the lactose or sugar in the milk into lactic acid. It curdles the proteins and causes souring.

The hygienic quality of fresh milk is determined by milk handling practices at the milk producer level and the cooling practices at the milk collection centers. Poor quality of milk at the collection level cannot be corrected further up the dairy value chain. Therefore, it is very important that cooling should be done within one or one-and-a-half hour of milking, after which the naturally occurring preservatives in the milk (including carbon dioxide) stop working.

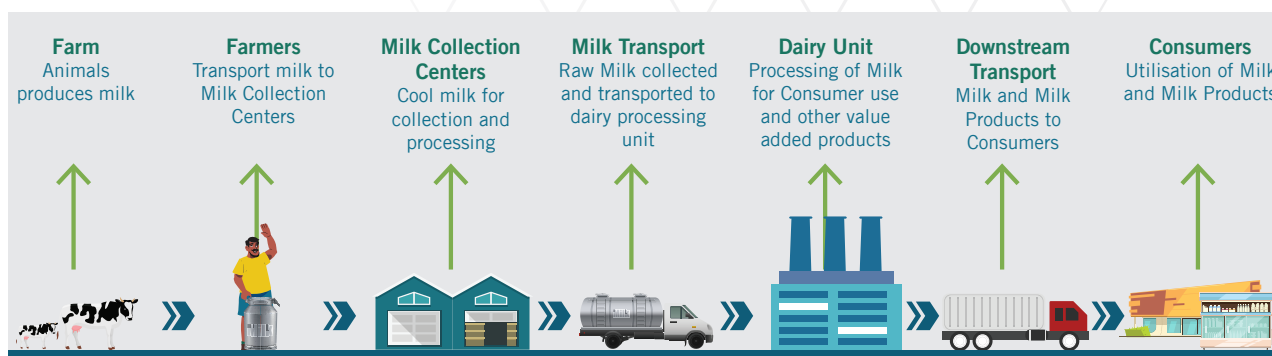
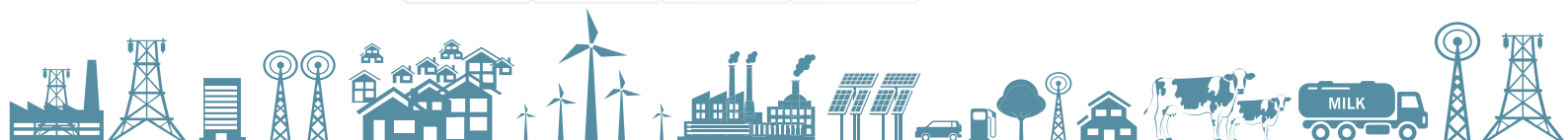

Figure 33: Dairy Value Chain

Dairies currently use bulk cooling tanks to cool their milk to about 4°C at their procurement centers. These tanks, of 1,000-5,000 litres capacity, keep the milk chilled till the tanker from the dairy arrives. These systems are designed as per ISO standards of cooling half of the rated bulk milk capacity to 4°C within 3 hours. Such standards work well for developed nations where milk production and cooling are co-located at the same vicinity. For India specific milk collection process, such coolers have following major drawbacks:

Table 62: Bacterial growth factor with milk temperature

Raw milk storage temperature (°C) for a period of 18 hours	Bacterial growth factor*
0	1.00
5	1.05
10	1.80
15	10.00



Raw milk storage temperature (°C) for a period of 18 hours	Bacterial growth factor*
20	200.00
25	1,20,000.00

- ❖ An average Indian farmer delivers less than 10 L of milk per day. Insufficient milk collection in a village to cater to a single bulk cooler forces milk cooperative to collect milk from nearby villages through milk societies. Uncooled milk collected from multiple societies is transported to a centralized bulk cooler before milk cooling process can be initiated. This entire process results in delayed and bulk arrival of milk at bulk cooler sites. Thus, milk is exposed to higher temperatures for a longer duration.
- ❖ Bulk coolers mostly operate at suboptimal capacity as there exist large variation in milk quantity production between lean and flush seasons. If these are undersized, cooling takes longer time. If these are oversized, the minimum milk requirement (typically ~15% of the tank volume) to start cooling process increases. Milk quality deteriorates in both the cases.
- ❖ Bulk coolers require the electric back-up via diesel generator sets, as electric grid supply is not reliable. It results in increased operational expenses and environmental pollution. In addition, diesel generators associated with these coolers are oversized by up to five times the rated power of compressor, just to handle the startup surge requirements. It results in additional diesel consumption due to part load operation.

Proposed System

Instant milk cooler is based on its thermal energy storage technology. It uses vapor compression cycle to convert electric energy into ice. This ice is later used to provide cooling without the need of grid availability during cooling process. Similar concepts of providing instantaneous cooling have been used at larger chilling centers, with capacity of 10,000 L/day or beyond. Efforts to miniaturize those systems have not been successful, simply because operating conditions and economics are totally different at small scale. It is an add-on to bulk cooler sites with following primary objectives:

- ❖ Delink the availability of grid supply and milk cooling requirement to minimize and even eliminate diesel generator.
- ❖ Eliminate the need of minimum milk quantity requirement of 15% of bulk cooler rated capacity to start the milk cooling process.
- ❖ Increase the cooling rates by three times to eliminate the impact of milk production variability on bulk cooler cooling capacities.
- ❖ Instant cooling of milk to reduce the overall time milk is subjected to elevated temperatures.

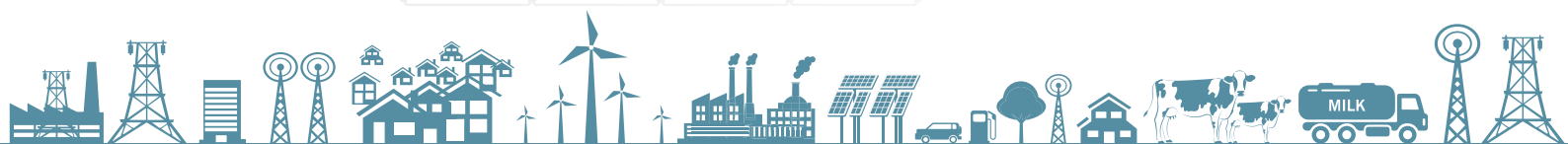

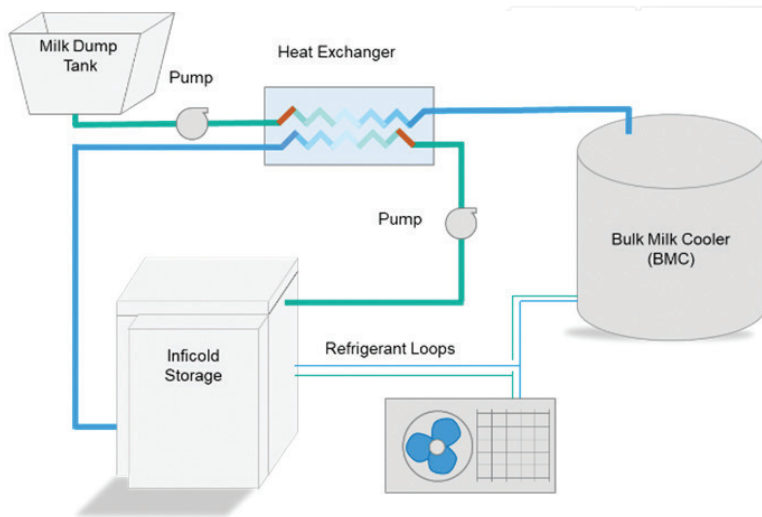

Figure 34: Schematic layout for Instant Milk Cooler

Instant milk cooler consists of an efficient ice bank tank, milk pump, plate heat exchanger and balance tank. Instant milk cooler automatically recharges its ice storage levels whenever grid power is available irrespective of the milk cooling requirements. It takes around 6-7 hours to fully charge the system with a single-phase grid supply. Milk is poured in the balance tank from where it is pumped in the plate heat exchanger to instant cool it to 4-7°C.

The milk flow rates are user adjustable in the range of 250-1,500 litre/hr. The outlet milk temperature is flow and quality dependent. The outlet temperature is 3-4°C milk outlet with milk flowrate of 250 L/hr; 5-7°C milk outlet with milk flowrate of 500 L/hr; and 8-10°C with milk flowrate of 1,000 L/hr, respectively. The energy storage in the ice bank tank is about 200 MJ.

The graph in the figure below compares the cooling provided by a standalone 2,000 L bulk milk cooler with a combination of instant milk cooler and 2,000 L bulk milk cooler. Milk flow rates used for the comparison were 1,000 litres per hour, and the total 2,000 litres of milk was collected. At the end of the test, average temperature of milk collected in the tank was 4°C in both cases. Average time for

2000L milk collected within 2hrs in a 2000L BMC

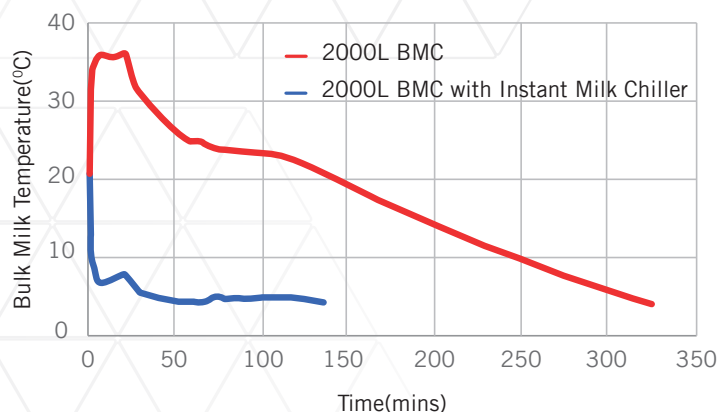
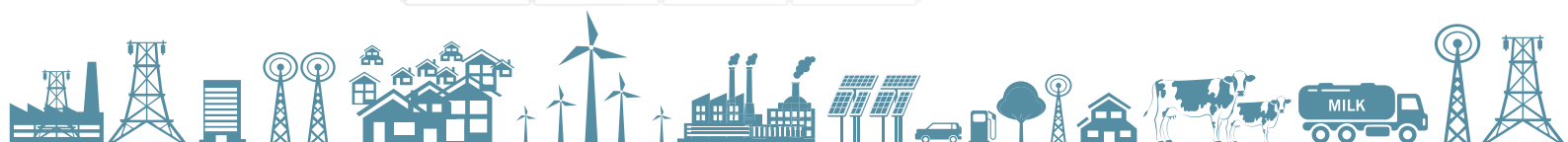

Figure 35: Cooling time with and without instant milk chiller

which milk was exposed to temperatures above 10°C is significantly higher with standalone 2,000 L bulk milk cooler. Since milk coming out of instant milk cooler is never above 10°C, the freshness and aroma of milk is maintained, and a great value addition is achieved.

Merits

- ❖ Improves milk quality from typical 50 mins to 120 mins of Methylene Blue Dye Reduction Test (MBDRT).
- ❖ Eliminates usage of diesel generator for up to 1,500 litres of milk collection in a shift when the system is fully charged with ice.
- ❖ Can be used to enhance the capacity of an existing bulk milk cooler by handling cooling load of up to 1,500 litres of milk in a shift without availability of any source of power.



- ❖ Instant milk improves the milk quality, and makes milk eligible for ultra-high temperature processing, which increases the sale value of the milk.
- ❖ Farmers at the installed pilot site have already started receiving INR 1/L. The extra income generation for the farmers is not considered in the payback analysis as it also depends on other milk handling practices. Assuming higher quality milk generates extra profit of INR 1 per litre, payback period is less than 6 months.

Limitations

- ❖ IMC is highly beneficial only when the dependence of BMC on Diesel Generator (DG) sets for power is high.

Cost Benefit Analysis

The expected fuel savings to be achieved by installing instant milk cooler in conjunction with a 2,000 L bulk milk cooler is 3.28 kL/year of diesel, which translates into annual monetary savings of INR 1.73 Lakh. The value generation due to improved quality of milk is INR 1/litre, which translates to **INR 7.30 lakh/annum, with a total investment of INR 4 lakh and a payback period of 6 months.**

Table 63: Cost Benefit Analysis – Instant Milk Cooler

Parameters	UOM	
Milk processed	kL/shift	1
	kL/day	2
	kL/annum	730
Average Power consumption by compressor of 2000L Bulk milk cooler	kW	5.6
Average Cooling duration of 2000L milk in bulk milk cooler	hrs/day	6
	hrs/annum	2190
Power Cut	%	50
Fuel Cost (HSD)	INR/ litres	64
Electricity cost (Grid power)	INR/ kWh	6
Total DG runtime	hrs/ day	3
	hrs/ annum	1,095.0
GCV of HSD	kcal/ kg	11,840
Density of HSD	kg/ m ³	826.3
HSD consumption for DG	litres/ hr	3
	kg/ annum	2,714.4

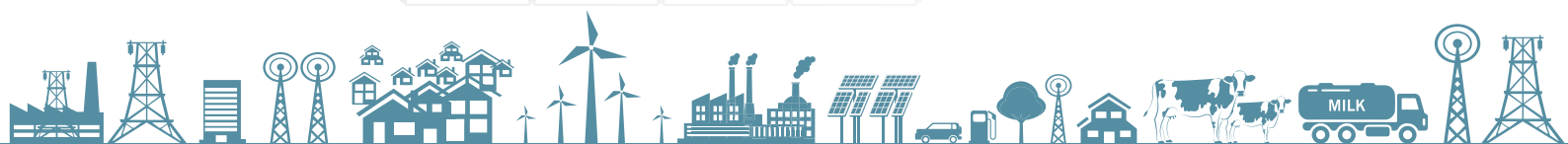

Parameters	UOM	
Thermal energy consumption from HSD	Mkcal/ annum	32.1
	TOE/ annum	3.2
	GJ/ annum	134.5
HSD savings	litres/ annum	3,285.0
Annual Cost Savings on Diesel	INR lakh/ annum	1.73
Value generation due to improved quality of milk	INR/litre	1.00
	INR lakh/ annum	7.30
Investment	INR lakh	4.00
Simple Payback	months	6
IRR	%	246.13
NPV at 70 % Debt (12% rate)	INR lakh	41.74

Energy & GHG Savings



Reference Plant Implementation

Table 64: Reference Plant Implementation – Instant Milk Coolers

Project Name	Installation of Instant Milk Coolers
Objective	Improvement of milk quality and reduction of operational energy expenditure by instant milk cooling.
Dairy profile	The milk collection had an installation of 2 units of 1,000 L bulk milk cooler along with 2 units of 10kVA diesel generator. 1 unit of instant milk cooler was installed at the site.

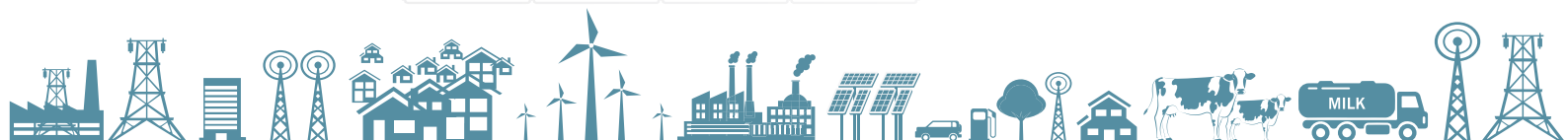

Project Name	Installation of Instant Milk Coolers
Installation Photo	
Assumptions Made	<ul style="list-style-type: none"> ❖ Average % Power outage – 18% ❖ Average daily milk collection – 2,000 L
Savings (INR lakh)	₹ 60,000 per annum on diesel + ₹ 7,30,000 per annum on improved milk quality.
Investment (INR lakh)	₹ 4,00,000
Simple Payback Period	6 months
Replication potential	In all the BMCs
Outcomes	<ul style="list-style-type: none"> ❖ Annual Fuel savings – 1,242 litres of diesel. ❖ Annual GHG reduction – 1,837 kg. ❖ Milk quality has improved and is now eligible for UHT production. ❖ Usage of diesel generator has been eliminated.

Vendor Details

Table 65: Vendor Details – Thermal Energy Storage for BMCs

Equipment Detail	Instant Milk Cooler
Supplier 1	
Supplier Name	Inficold India Private Limited
Address	G-21, Sector 11, Noida – 201301, Uttar Pradesh, India.
Contact Person	Dr. Nitin Goel
Email Id	ng@inficold.com
Phone No	+91-9873518652
Supplier 2	
Supplier Name	Promethean Spenta Technologies Private Limited
Address	Survey 25 / 2K, Ravet Road Near Dange Chowk, Tathawade, Pune – 411033 India
Contact Person	Jofi Joseph
Email Id	Jofi.joseph@gmail.com
Phone No	+91-7507776727

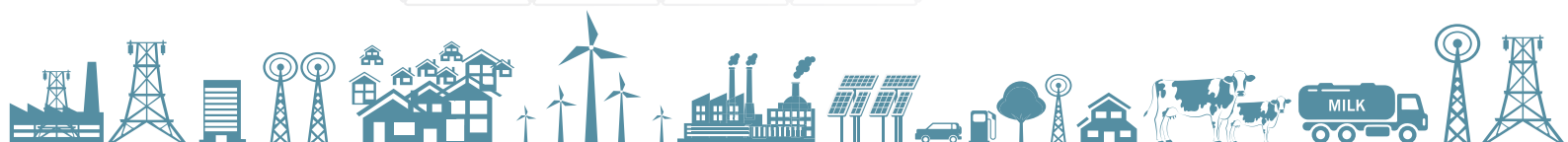

4.3.2 BMC Remote Monitoring System

Baseline Scenario

Milk is procured from remote village farmers. Societies (collection centres) are established for this purpose. Upon receipt of milk, it is expected to be chilled immediately to 4°C. Otherwise, milk quality will be degraded on account of microbial multiplication. For this reason, chilling centres are put in place at feasible locations. Milk is chilled to 4°C at the chilling centres till it is lifted by the dairy tankers. The dairy union has installed 78 Bulk Milk Coolers located remotely at a distance of 50-70 km. The 78 BMCs are divided into 21 routes. The 21 different milk tankers go and lift the milk from these 78 BMCs and bring it to the dairy unit for further processing. Each centre has a BMC technician to look after the collection and proper chilling. The total chilling capacity of the union is 100 TLPD. There are 78 Bulk Milk Coolers and 386 Automatic Milk Collectors in the union. The union procures on an average 4.44 lakh kg/day of milk and sells 2.42 lakh litres/per day.

Methylene Blue Dye reduction test is used in the Dairy industry to judge the quality of milk. Better MBRT fetches better price as it can be used to make other premium products. In MBRT test 1 ml of Methylene blue dye solution is added to 10 ml of milk sample. The colour of the solution turns blue. The blue solution is kept under a water bath at 37°C. This time is noted. Then frequently the solution is observed. The time at which the solution turns colourless is noted. The time interval for it turning colourless from blue is the value of MBRT in minutes. The milk is rated as per this table:

Table 66: Milk rating as per MBRT

MBRT Value in min	Rating
300 min and above	Very Good
180 – 240 min	Good
60- 120 min	Fair
30 min or Less	Poor

The union wanted to have an insight into the operation of the BMC. This was required for procuring better quality of milk. The only way is to get reports from the BMC Technicians. The reports required a lot of human effort, and are prone to errors. Moreover, the technicians were mostly villagers and were not much to count on. Hence, there is a need for automation to avoid the errors.

The lifting temperature and volume of milk of each BMC (Bulk Milk Cooler) from each chilling centre was observed and noted. On arrival at the dairy again the arrival temperature was noted down. MBRT test was performed on the samples received and its values were also noted. As can be seen from the graph the line in blue represent the MBRT value in minutes on a daily basis from start date of study till the date of installation. It can be seen that the lowest value of MBRT is 150 min and highest is 175 min. The average value is around 170 min. For approximately a month the MBRT data was captured for all the routes.

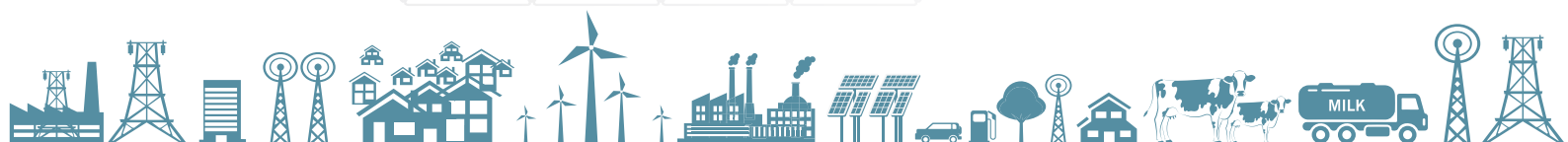

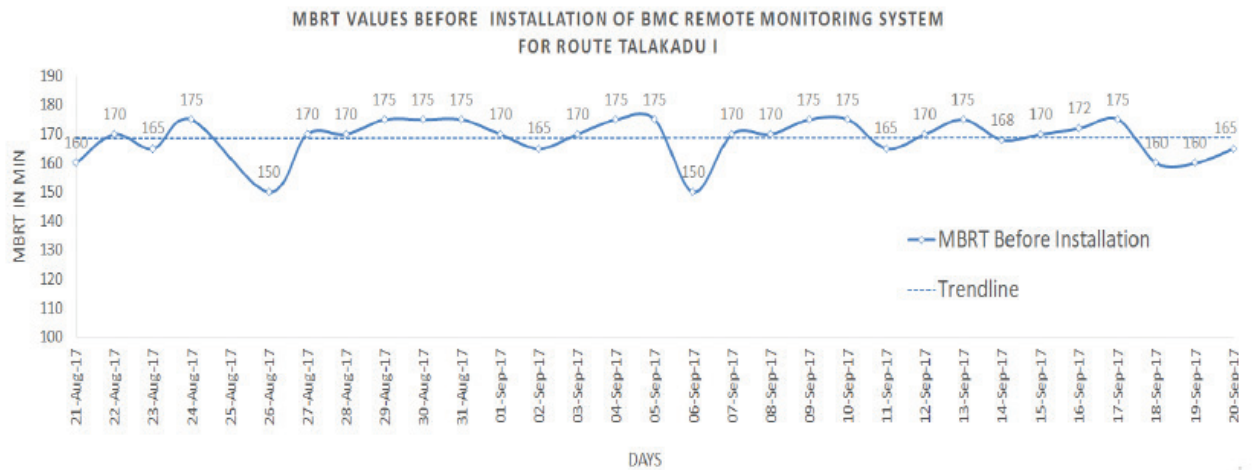

Figure 36: MBRT before installation of remote monitoring system

Proposed System

BMC Remoted Monitoring System has been installed one by one at respective sites. The feedback data was made available from remote sites. After BMC Monitoring system was online different type of alerts can be generated and sent. The alerts are categorized into two:

- ❖ Info Alerts like the Power On/Off, DG On/Off, Agitator On/Off, CIP (Clean in place), Chilling start/stop.
- ❖ Critical Alerts like the DG-Grid-both on, Turn on Chilling, Over-Cooling, CIP Undetected, Lifting at High temperature.

Dashboard list of BMCs

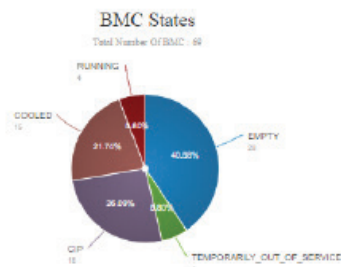

Req.Id	Name	Location	Current state	Milk available	Temperature	Details
BMC_2366	barathipura mymul	barathipura mymul	Empty	No	19.8	▶
BMC_2367	G B sergur mymul	G B sergur mymul	Empty	No	25.1	▶
BMC_2368	Gangadahosahali mymul	Gangadahosahali mymul	Empty	No	23.5	▶
BMC_2369	hegganur mymul	hegganur mymul	Out of service	No data		▶
BMC_2370	Indiranaqara mymul	indiranaqara mymul	CIP	No	22.5	▶

Figure 37: Dashboard list of BMC

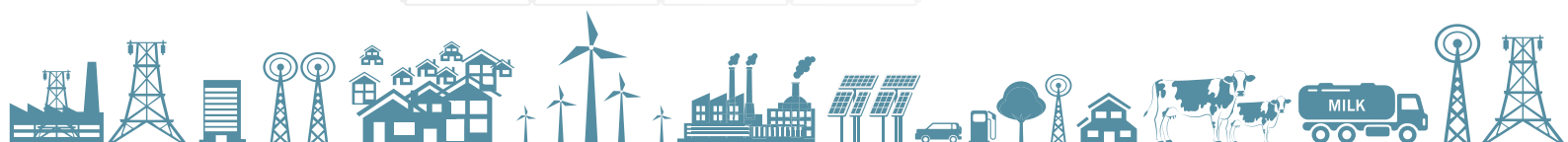

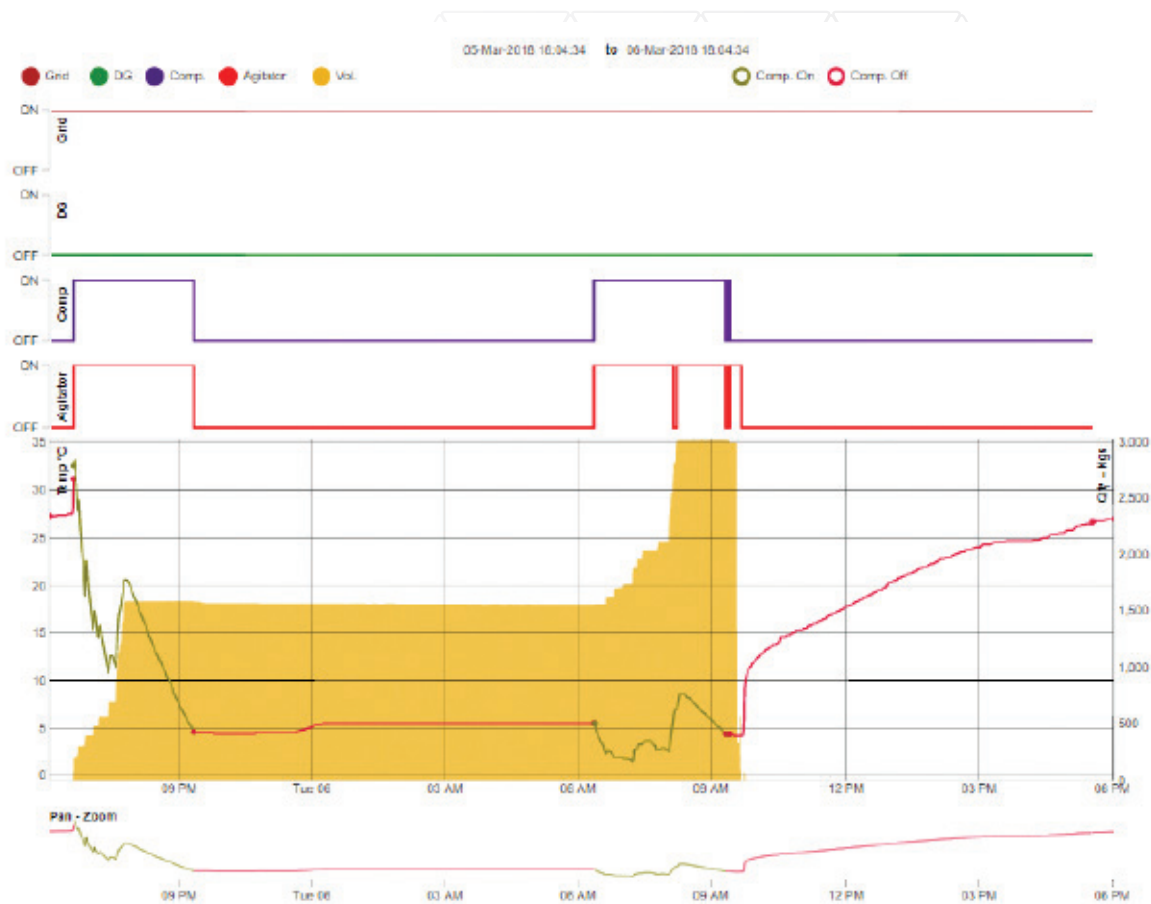
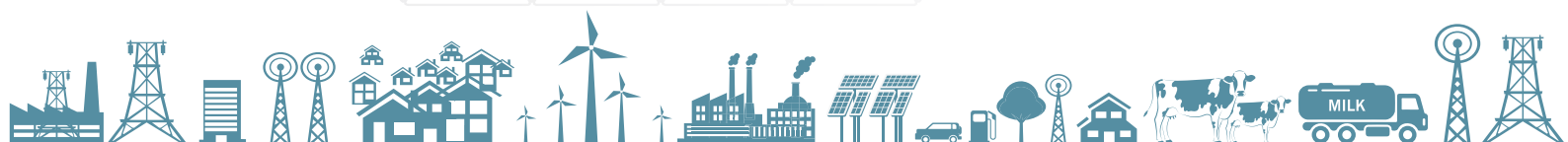

Figure 38: Chilling graph

The data from remote monitoring system is closely monitored and analysed as shown below:

- ❖ BMC's prepared reports related to the Diesel Generator (DG) fuel Consumption. Running hours of the DG is calculated using hour meter for the complete month. Using the consumption rate the fuel consumed for the month is calculated. This Data was read vis-à-vis the data from the BMC Remote Monitoring System to ensure effective usage of DG. It ensured not using of DG when power was not available and thereby saving on the fuel cost.
- ❖ Volume lifted at site as per the challan is compared with the volume data available from the BMC Remote Monitoring system. This data is then cross verified with the actual volume measured at dairy plant to check for inconsistencies.
- ❖ Several reports were prepared on the MBRT, lifting temperature, fat & SNF values of milk from all the routes. Lifting temperature data in the challan is compared with the data from the BMC Remote Monitoring System. and was correlated with the milk temperature on arrival at dairy plant. Corrective measures were taken to ensure milk temperature on arrival was between 4°C & 6°C.

After the installations, below is the graphical representation (Refer Figure 7 below) of MBRT vs time for the same route considered above. As can be seen from the graph the line in red represent the MBRT value in min on a daily basis from the date of installation for a period of 1 month. It can be seen that the lowest value of MBRT is 180 min and highest is 265 min. The average value is around 220 min.



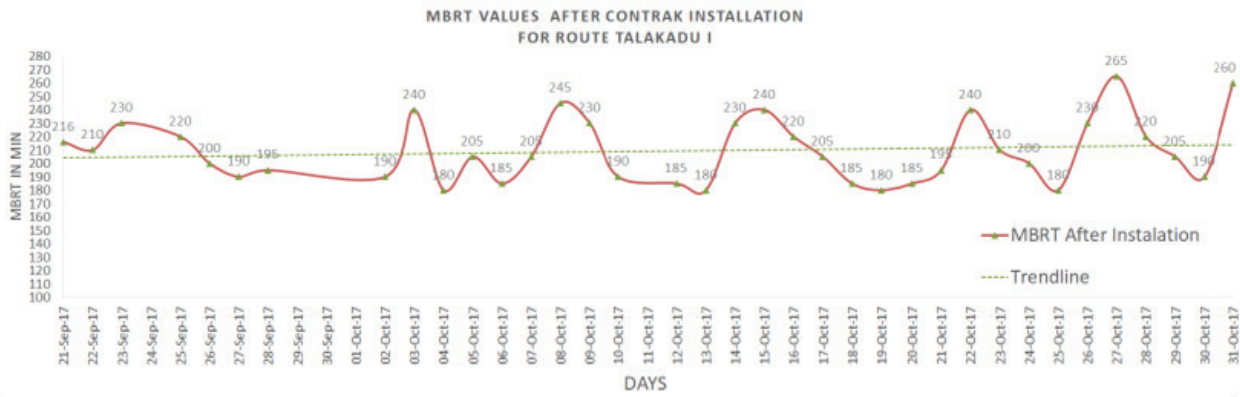

Figure 39: MBRT after installation of remote monitoring system

It can be seen from the graph that the MBRT value is on an increasing trend. From an average value of 170 min of MBRT, it rose to an average value of 220, which is an increase of 50 min. This indicates improvement in milk quality. This means less rejection of potential revenue and more revenue realizations. Increased MBRT of milk through BMC remote monitoring solution has helped dairy companies to add premium milk products (UHT milk, etc.) which also adds to the revenue realizations. Operation costs were reduced because of fuel/power savings by better monitoring. With remote monitoring, the number of technicians required was reduced. Thus, increase in realization per litre of milk and reduced cost of operations helped milk union to ensure RoI within six months.

Merits:

- ❖ Quantity mismatch from BMC in terms of tanker volume and procured volume can be reduced significantly. This was due to the reduced pilferage or in-accurate Dip Stick for milk quantity measurements.
- ❖ Diesel consumption for chilling can be reported more accurately. Actual number of hours of chilling based on DG can be reported accurately and hence diesel consumption is tracked at central location.
- ❖ BMC capacity utilization has been improving as the volume is monitored centrally, and route managers are directing milk to emptier BMCs, and also manage tanker routes optimally.
- ❖ Availability of monitoring parameters for proper chilling from remote place to a central location, made possible and data analytics to identify the shortcomings for the proper chilling made

Demerit

- ❖ Investment Cost

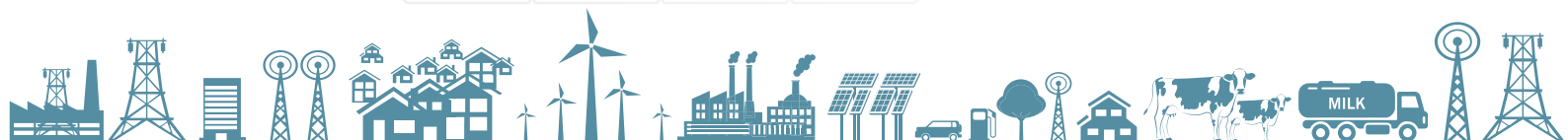

Cost Benefit Analysis

The expected savings by installation of Remote Monitoring System for BMC is **INR 3.27 per litre chilled with an investment of INR 0.06 per litre for the setup.**

Table 67: Cost benefit analysis - BMC remote monitoring

Parameters	Value INR
Revenue increment per litre due to improved quality & reduction of rejection	3.00
Cost savings per litre due to energy consumption reduction	0.055
Cost savings per litre due to reduction in manpower	0.10
Cost savings per litre due to preventive maintenance	0.00657
Cost savings per litre on Cleaning in place	0.12
Cost savings per litre on pilferage reduction	0.048
Per litre benefits due to monitoring setup	3.33
Per litre cost of monitoring setup	0.06
Net Benefits per litre	3.27

Vendor Details

Table 68: Vendor details - BMC remote monitoring system

Equipment Detail	BMC Remote Monitoring System
Supplier Name	Stellaps Technologies Pvt Ltd
Address	No 46/4, Novel Tech Park, 3rd Floor, Hosur Rd, near Kudlu Gate, Garvebhavi Palya, Bengaluru
Contact Person	Mr. Nikhil Raj
Email Id	nikhil.raj@stellapps.com
Phone No	9846878283

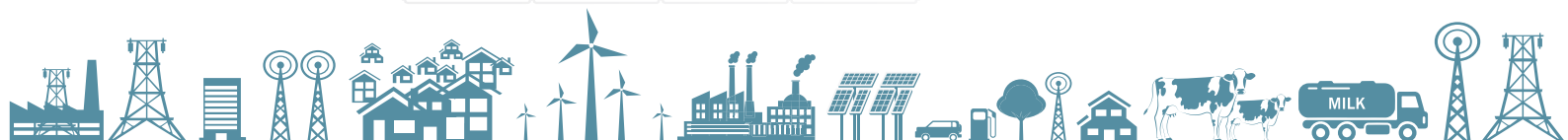

4.4 Case Studies – Utilities

4.4.1 VFD for air Compressor

Baseline Scenario

The dairy unit under consideration has installed a 15 kW screw compressor to cater to the requirements in the process and instrumentation section. The maximum working pressure of the compressed air in the system is in the range of 6-7 kg/cm². The operating characteristics of the compressor are shown below:

Table 69: Plant compressor loading pattern

Tag No.	Load %	Unload %	Load power, kW	Unload power, kW
Plant air compressor	36	64	17.5	6.6

The loading percentage of the compressor is only 36%, indicating a potential to install for VFD installation in the compressor. During the time the compressor goes into unload mode, there is no useful work done. Also, since the compressor is of screw type, the losses during unloading are higher in comparison with that of a reciprocating system.

Concept of VFD

Any compressor is designed to go into load & unload conditions. The load and unload pressures for any compressed air system are set such that the average pressure delivered will be the required system pressure. The higher set point of the compressor therefore is a loss.

Also, in the present scenario, the installed compressor is of much higher capacity than compared to the system requirement, which is clear from the 64% unload that the compressor is operating with.

In these two conditions, the most suitable option is to go for a variable frequency drive (VFD). The difference between the normal & VFD condition in a compressor is as shown in the figure here.

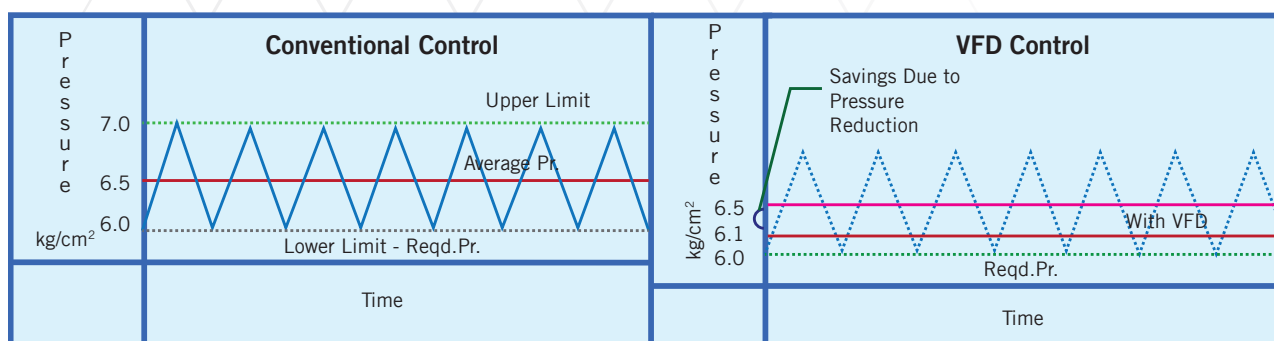
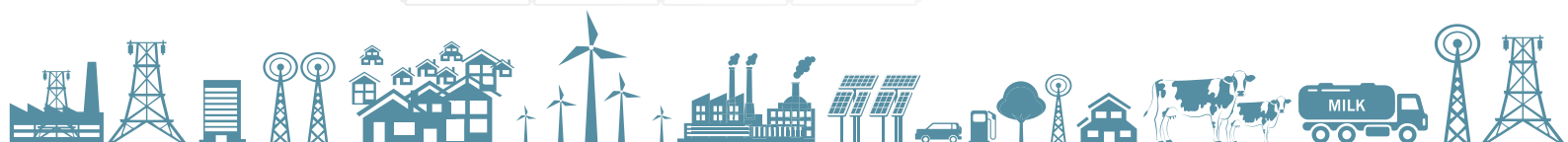

Figure 40: Capacity control of compressor

As can be seen from the figure, the VFD can be given a set point equal to that which is required in the system. The additional power that the compressor consumes over the required pressure will be the savings achieved.



Proposed System

It is recommended to install VFD and operate that with closed loop for all the above listed compressors to avoid the unloading of the compressors. The feedback for VFD can be given as required receiver pressure. By installing VFD, the compressor can be operated in a pressure bandwidth of ± 0.1 bar. Saving potential of 4.2 kW is available by means of installation of VFD in the Main plant air compressor.

Merits

- ❖ Reduced fluctuations in pressure.
- ❖ Ease of operation.
- ❖ Reliability.

Limitations

- ❖ Viable only up to 40% unload situations.
- ❖ Maintenance issues.
- ❖ Space constraints.

Cost Benefit Analysis

The expected savings by installation of VFD in the compressor is 1,8247 units annually. The annual monetary saving for this project is **INR 1.03 lakh, with an investment of INR 0.90 lakh and a payback period of 11 months.**

Table 70: Cost Benefit Analysis - VFD for Air Compressor

Parameters	UOM	Value
Unloading power of compressor	kW	6.6
Percentage unloading	%	64
Power savings	kW	4.2
Annual operating hours	hrs	4,320
Annual energy savings	kWh	18,247
Power cost	INR/kWh	5.65
Annual savings	INR lakh	1.03
Investment	INR lakh	0.9
Payback	months	11
IRR	%	142.02
NPV at 70 % Debt (12% rate)	INR lakh	4.81

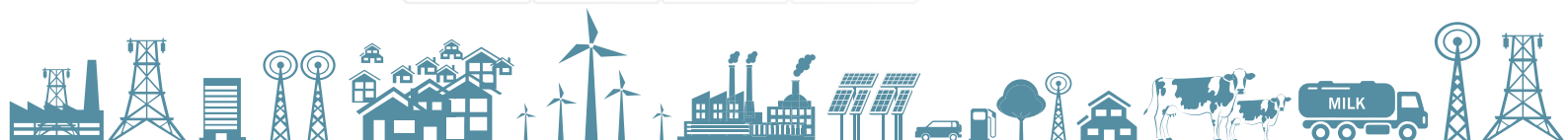

Energy & GHG Savings



Vendor Details

Table 71: Vendor Details – VFD for Air Compressor

Equipment Detail	VFD for compressors
Supplier Name	Danfoss Industries Ltd
Address	703,7th Floor, Kaivanya Complex, Near Panchwati Cross Road Ambawadi, Ahmedabad
Contact Person	Mr. Srihari Vyas
Email Id	Shrihari@danfoss.com
Phone No	9825024991

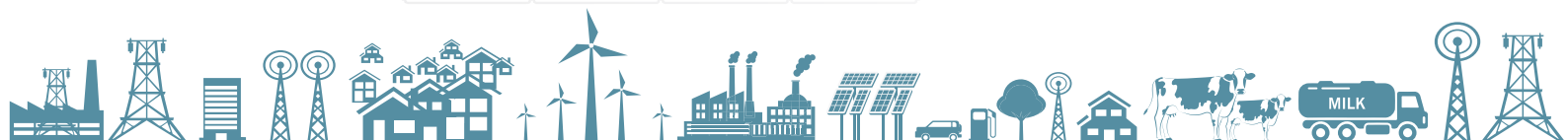

4.4.2 Energy Efficient Pumps

Baseline Scenario

The unit has installed two chilled water pumps for pumping chilled water from IBT to process, of which one is running and the other one is on standby. The chilled water is used in pasteurization process and pre-chiller, where the milk is cooled to 4°C. Chilled water required for the various processes is pumped using two pumps of 5.5 kW capacity each. After the process, the return water is coming at 6°C-8°C. The figure below shows the schematic of chilled water system in the plant:

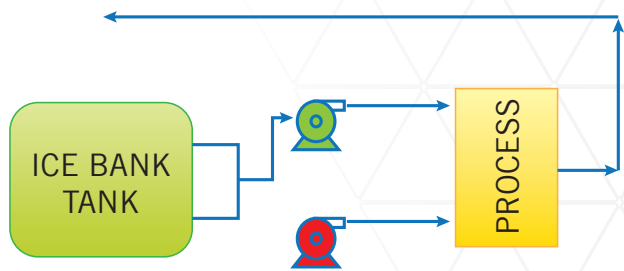

The design efficiency of the pump is 39%, which is very low, and the measured efficiency is 31%, which is lower than the design efficiency. The reasons for low efficiency of pump are:

- ❖ Poor operational practices.
- ❖ Pump is very old and undergone frequent maintenance.
- ❖ Poor selection of pump.

Figure 41: Chilled Water Pumping Systems

Proposed System

It is recommended to replace the old chilled water pump with energy efficient pump. The highly efficient pump will consume less power than low efficiency pumps, which will lead to energy saving. Energy efficient pumps offer higher efficiency than conventional pumps and consume less power, thereby leading to significant energy savings. The new pumps installed have an overall efficiency of 53%. The pump – system curve is illustrated graphically as shown. The point where the system and the pump curve meet is known as the **Best Efficiency Point (BEP)**. The operating efficiency is highest and the radial bearing loads are lowest for a pump at this point. At or near its BEP, a pump operates most cost effectively in terms of both energy efficiency and maintenance. In practical applications, operating a pump continuously at its BEP is not likely, because pumping systems usually have changing flow

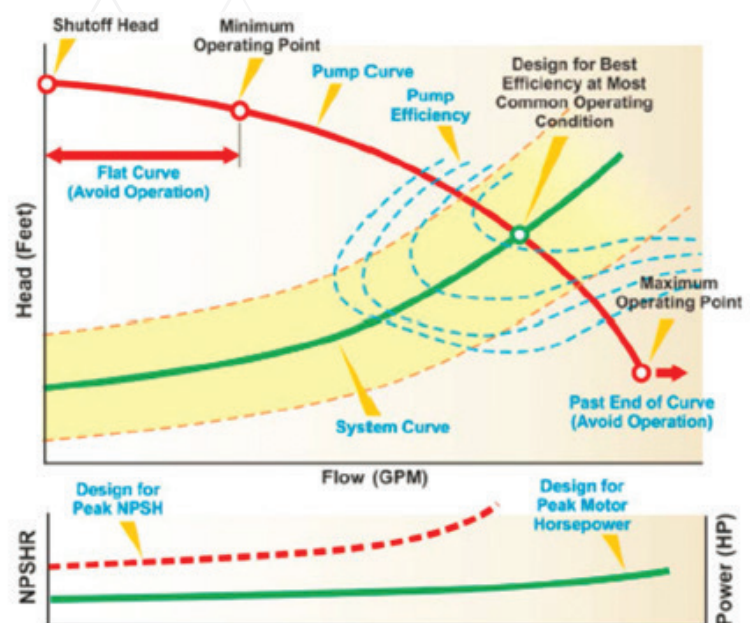

Figure 42: Pump Characteristic Curve

rate and system head requirements and demands. Selecting a pump with a BEP that is close to the system’s normal operating range can result in significant operating cost savings.

Merits

- ❖ Higher operating efficiencies.
- ❖ Reduced power consumption.
- ❖ Optimum flow & head.

Limitations

- ❖ High installation cost.
- ❖ May require system stoppage during installation.

Cost Benefit Analysis

The expected energy savings to be achieved by installation of new energy efficient pumps is 17,520 units annually. The annual monetary saving for this project is **INR 0.70 lakh, with an investment of INR 0.98 lakh, and a payback period of 17 months.**

Table 72: Cost Benefit Analysis – Energy Efficient Pump

Parameters	UOM	Present	Proposed
Power Consumption	kW	6	4.5
Flow	m ³ /hr	15.5	16
Head	m	40	45
Efficiency	%	35	51
Power Savings	kW		1.5
Electricity Cost	INR/kWh		4
Operating hrs	hrs/day		8.00
Energy Savings	kWh		17,520
Cost Savings	INR lakh		0.70
Investment	INR lakh		0.98
Pay Back	months		17
IRR	%		66.74
NPV at 70 % Debt (12% rate)	INR lakh		2.34

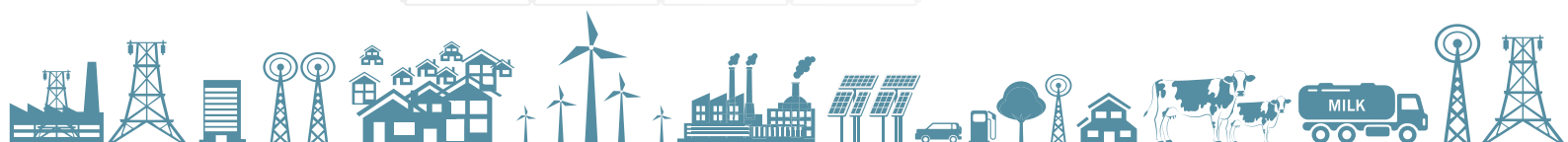

Energy & GHG Savings



Reference Plant Implementation

Table 73: Reference Plant Installation: Energy Efficient Pump Sets

Project Name	Installation of energy efficient pumps
Objective	Replacement of old chilled water pumps with energy efficient pumps
Unit profile	Trivandrum dairy - a unit under Thiruvananthapuram Regional Co-operative Milk Producers' Unions (TRCMPU) of MILMA, having its plant at Ambalathara, Trivandrum, Kerala, offers pasteurized Vitamin A enriched milk and various milk-based products such as Butter, Ghee, Paneer, Curd, buttermilk and ice cream throughout the state.
Installation Photo	
Assumptions Made	<ul style="list-style-type: none"> ❖ Electricity Cost : 6 INR/kWh ❖ Operating hrs : 14 hrs/day ❖ Old Pump Efficiency : 42
Savings (INR lakh)	₹ 1.39
Investment (INR lakh)	₹ 2.20
Simple Payback Period	19 months
Replication potential	All dairies irrespective of size

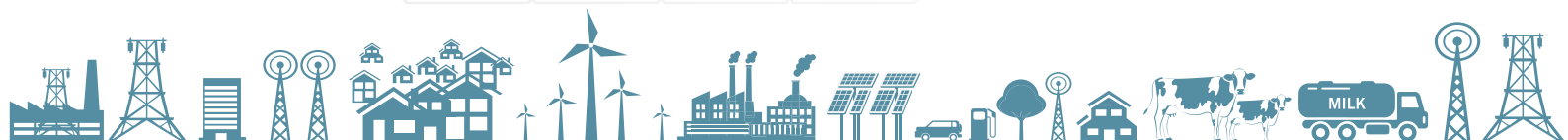

Project Name	Installation of energy efficient pumps
Outcomes	<ul style="list-style-type: none"> ❖ Efficiency of pump: 53 % ❖ Power Savings: 4.52 kW ❖ 1.99 TOE of annual energy savings. ❖ Carbon footprint reduction of 18.48 TCO₂ per year.
Unit contact details	<p>Mr. Balasubramony G Trivandrum Dairy Ambalathara, Poonthura.P.O, Thiruvananthapuram – Kerala Phone: 9633802195 Email: milmatdengg@gmail.com</p>
Cluster Reference	Kerala

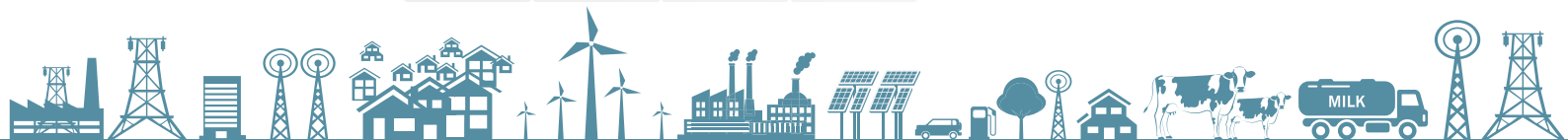
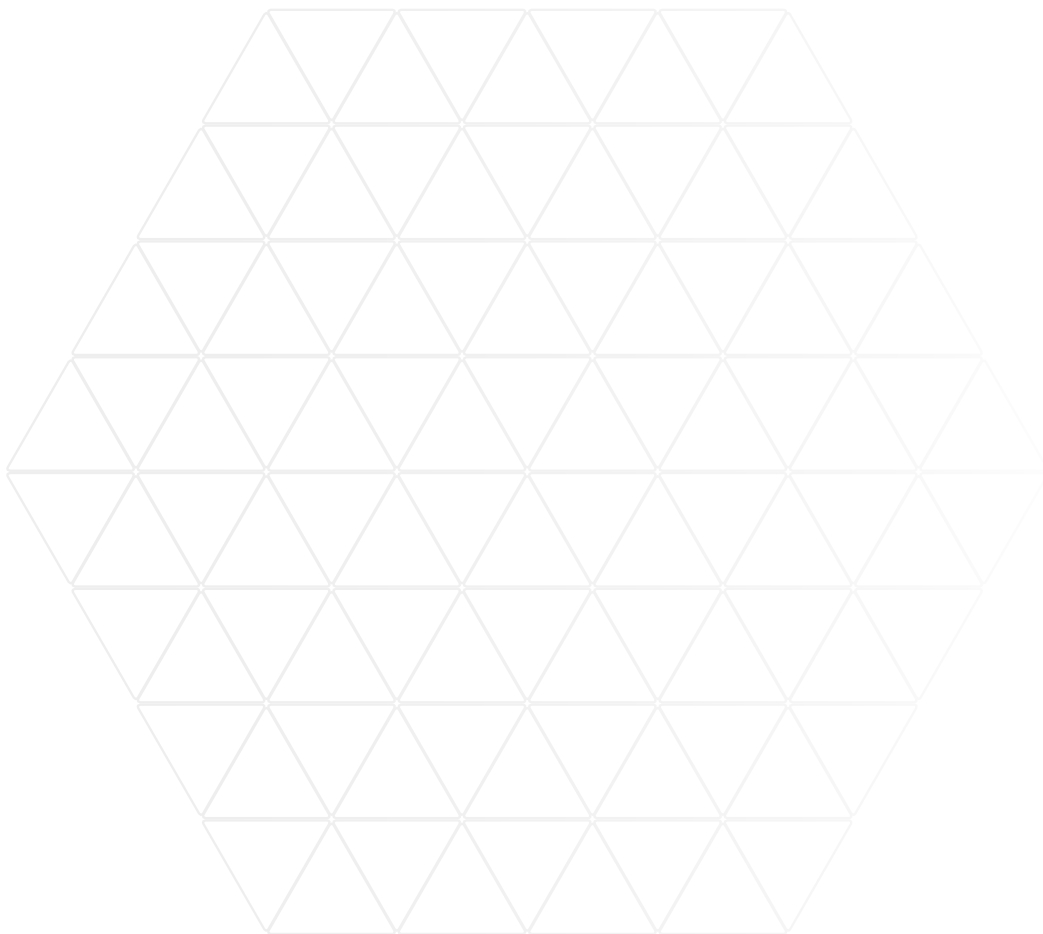

4.4.3 Package Type Biogas Reactor

Baseline Scenario

The unit has a canteen catering food to around 600 employees. Currently, for all cooking purposes, biogas from ETP and Liquid Petroleum Gas (LPG) is used as fuel. The average amount of food waste generated per day from the canteen is 500 kg. It is disposed of outside.

However, the canteen waste being organic in nature and high in organic content, can be converted into biogas and manure, using an anaerobic digestion process. The anaerobic digestion process would address two aspects: generation of non-fossil fuel-based energy, and the avoidance of waste going to landfill. The biogas generated can be further purified and can substitute the use of LPG in the canteen. The manure generated from the process can be used for gardening. Recently, there have been many developments in biogas digestion technologies, and the economics have also improved substantially. With rising fossil fuel prices, especially that of LPG, the installation of bio-digesters to generate biogas can be a good substitute for conventional energy and would result in both environmental and cost benefits for the company.

Proposed System

The most commonly used models are fixed dome reactors, floating drum reactors, and, of late, there has been development of a few mild steel-based digesters. There has not been much innovation in design during the last several years. With old designs, the usage of mild steel and concrete also adds up to the cost of the digester. One of the main challenges has been developing digesters with simplicity in operation and maintenance. Mild steel digesters have major challenges, such as rusting due to H_2S content in the biogas, and exposure to wet weather conditions, among other problems.

It is recommended to install biogas plant, which is a fabric-based biogas technology, for processing the 500 kg of food waste produced daily. This technology would process all the canteen waste generated inside the plant, which is a better alternative to disposing of it outside.



Figure 43: Fabric used for biogas

The schematic layout of the proposed system is given below:

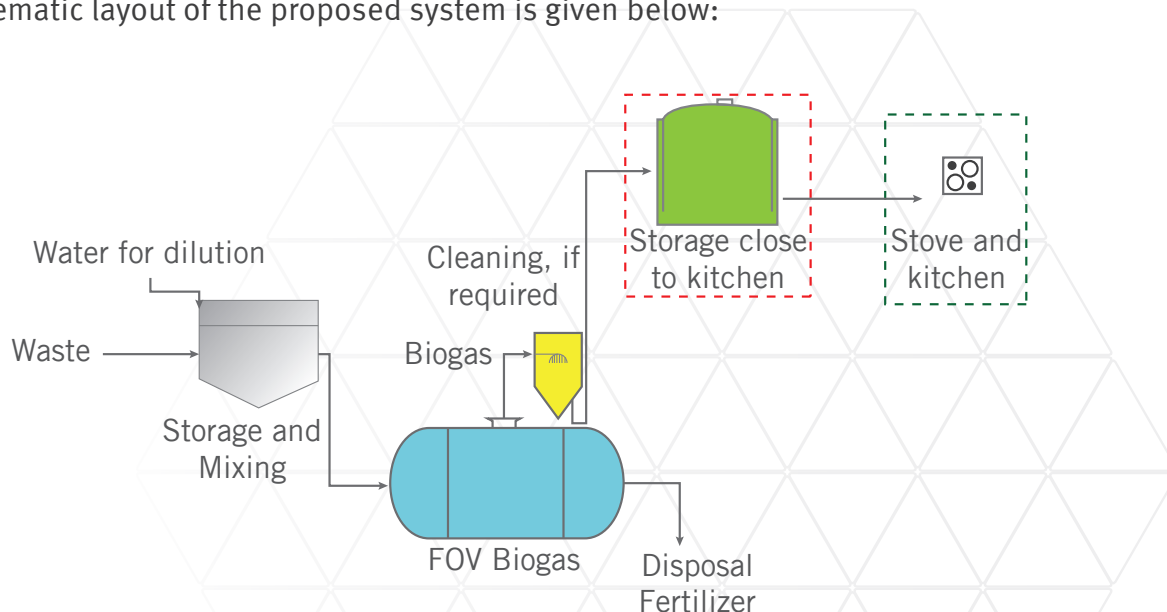

Figure 44: Layout of FOV Biogas Technology

The biogas plant will be initially loaded with active inoculum to start the process. After the initial loading is complete, the 500 kg of food waste is mixed with 500 litres of water to reach a slurry form by feeding in a crusher. The slurry will be fed in to a feeding tank. The organic waste from the feeding tank will be fed into a 50 m³ biogas reactor. The reactor will have 30 m³ liquid space, and rest 20 m³ as gas storage space. The additional gas generated can be stored in a gas holder. About 1 m³ of diluted organic waste in a slurry form will be fed into the reactor every day. The excess liquid slurry coming out of the digester can be re-circulated as replacement for fresh water.

On an average, the reactor will have a 30-day retention time. Under optimized running conditions, the biogas plant will generate about 50 m³ of biogas per day. The feeding and digestate collection is a continuous process. The biogas generated will be piped to the kitchen and used for cooking by using biogas burners. The total area required for the biogas plant is about 80 m² of space. The design of the biogas plant can be adjusted according to space availability.

Benefits of new system

- ❖ Plug and flow digester (no settlement of sludge, natural mixing of organic waste).
- ❖ Low operations and maintenance costs.
- ❖ No rusting, unlike other designs, which are made of mild steel for digester tanks and for gas collection.
- ❖ No moving parts used for feeding, mixing and sludge outflow, since all the operations are based on natural gravity-based process. Very low captive power consumption for operating the digester.
- ❖ In-built gas space at the top of digester, which can hold up to 50% of total gas generated.
- ❖ Highest material quality.

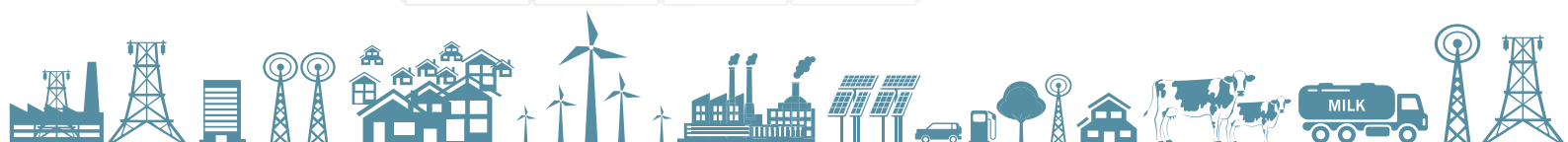

Limitations

- ❖ High investment cost.
- ❖ Continuous availability of feed to reactor.

Cost Benefit Analysis

The expected energy savings to be achieved by installation of biogas technology is 9,000 kg of LPG annually, with energy reduction of 10.65 TOE/year. The annual monetary saving for this project is INR 4.79 lakh, with an investment of **INR 11.12 lakh, and a simple payback period of 27 months.**

Table 74: Cost Benefit Analysis – Biogas Reactor Systems

Parameters	UOM	Existing System	Proposed System
Canteen waste generated per day	kg	500	500
LPG used per day	kg	25	NIL
Gas Potential from 500 kg waste	m ³ /day	50	50
Operating days/annum		360	360
Annual Energy Savings	kg LPG	-	9,000
LPG Cost	INR/kg	53.23	53.23
Annual Cost Savings	INR/lakh		4.79
Investment	INR/lakh		11.12
Payback	months		27
IRR	%		62.31
NPV at 70 % Debt (12% rate)	INR lakh		19.19

Energy & GHG Savings



Reference Plant Implementation

Table 75: Reference Plant Implementation – Biogas Reactor

Project Name	Installation of Biogas Reactor
Objective	Installation of 500 kg/day biogas plant to process food waste from canteen, pizza wastes and solid waste, and generate energy for cooking in canteen.
Unit profile	Amul Fed Dairy is a large-scale dairy unit located at Gandhinagar, Gujarat. The various products manufactured in AFDG dairy are liquid milk, butter milk, flavored milk, lassi, ghee and ice cream, with an average milk processing capacity of 32 lakh LPD.
Installation Photo	
Assumptions Made	<ul style="list-style-type: none"> ❖ Canteen waste generated per day is 500 kg. ❖ Operating days – 360 ❖ Gas potential is 50 m³/day ❖ LPG cost – INR 53.23/kg
Savings (INR lakh)	INR 4.79
Investment (INR lakh)	INR 11.12
Simple Payback Period	28 months
Replication Potential	In all large dairy units (> 10 lakh LPD) and cattle farms
Outcomes	<ul style="list-style-type: none"> ❖ 25 kg per day LPG savings of monthly energy saving ❖ 10.66 TOE of annual energy savings ❖ 26.82 t CO₂ reduction per year
Unit contact details	<p>Mr. Prashant Seth Amul Fed Dairy Plot No 35, Gandhinagar Ahmedabad Road ,Bhat , Gujarat Phone: 07574802084 Email: prashant.sheth@amul.coop</p>
Cluster Reference	Gujarat Dairy Cluster

4.4.4 Methane Capture from dairy effluents

Baseline Scenario

The unit has installed a 300 kLPD ETP plant to treat the effluents from various processes, the effluents generated from various sections of the production facilities are first received in a collection tank. Before mixing in an equalization tank, the effluents are passed through a fat trap unit. The low-density semi-solids, which float in the tank and contain fats, proteins, packing materials, etc., are known as 'dairy effluent scum' and are removed manually. After removing the dairy effluent scum (top layer), the effluents are further treated in aerobic or anaerobic conditions. The characteristics of dairy effluent scum vary with the products being produced in the plant and their relative proportion, as well as the methods of the operation used. The process involved is as below:

- ❖ Equalization tank for collection of raw effluent generated from plant for homogenization of the quantity and quality.
- ❖ Anaerobic biological treatment for removal of most of the suspended and dissolved organic impurities – it includes an Upflow Anaerobic Sludge Blanket (UASB) reactor followed by a settling tank.
- ❖ Aerobic biological treatment unit for polishing of aerobically treated effluent to achieve statutory disposal norms – It includes an aeration tank followed by a settling tank.
- ❖ Polishing treatment units: For further purification of treated effluent - It includes a dual media pressure filter, an Activated Carbon Filter, a Micron Filtration System, an Ultra-filtration system and a Reverse Osmosis system.

Effluent Characteristics:

Table 76: Effluent Characteristics

Sr. No.	Parameter	Raw Effluent	After Anaerobic	Treated Effluent
1	Effluent flow rate	300 m ³ /day	300 m ³ /day	300 m ³ /day
2	pH	4.0 – 9.0	7.0 – 8.5	7.0 – 8.5
3	Temperature	< 40° C	< 35° C	< 35° C
4	Chemical Oxygen demand (COD)	4,000 mg/l	< 600 mg/l	< 100 mg/l
5	Biochemical Oxygen demand (BOD)	2,500 mg/l	< 200 mg/l	< 30 mg/l
6	Oil & Grease	50 mg/l	< 20 mg/l	< 10 mg/l
7	Total Suspended Solids	500 mg/l	< 150 mg/l	< 50 mg/l

The wastewater generated from the unit will have various pollutants which exert high BOD and COD load. From the above table it is observed that incoming dairy effluent has a BOD of 2,500 mg/l and COD of 4,000 mg/l, which after treatment is reduced to less than 30 mg/l and 100 mg/l respectively.

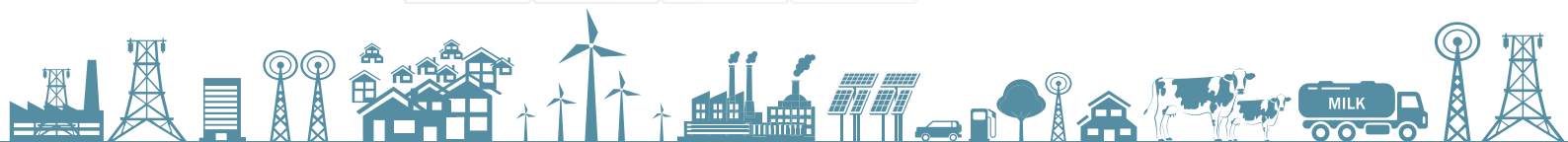

Current Treatment Process:

The raw effluent 300 m³/day from different trade activities flows to ETP by gravity. It first gets collected in equalization tank for homogenization of the quantity and quality. Acid/ Alkali solution is added to neutralize the effluent, if required. Homogenized and neutralized effluent from equalization tank is pumped @15 m³/h to UASB reactor bottom and distributed uniformly through the inlet distribution system. It passes upwards through the dense anaerobic sludge bed. Organic matter is rapidly utilized by biomass and converted to methane rich biogas. Upward circulation of water and biogas purging from the bottom of the reactor keeps the biomass in suspension and breaks any scum formation. The three-phase separator at the top of the UASB reactor allows effective degasification to occur. The dense, granular sludge particles, devoid of attached gas bubbles, sink back to the bottom establishing a return downwards circulation. The treated effluent flows into collection channels at the top of the settlers for discharge and transferred to the clarifier – 1. Washed out anaerobic biomass is recovered and recycled to the reactor. Excess biomass from Anaerobic Process is wasted to sludge dewatering system, if required. Biogas is collected in gas collection portion of three phase separator at the top of the reactor and transferred to a waste gas burner. Aerobically treated effluent is transferred to aeration tank. A culture of aerobic bacteria decomposes organic impurities into CO₂. A coarse bubble aeration grid is provided to supply O₂ to aerobic bacterial culture. Air is supplied by the same twin lobe air compressor system. Treated effluent flows through the clarifier - 2 to retain bacterial culture. The heavy biomass flocs get settled in the bottom and clear treated effluent flows into outlet channel. Aerobically treated effluent is collected in a treated effluent collection sump, it is pumped to Dual media pressure filter for polishing. Reclaimed water will be suitable for irrigation or feeding to softener for reuse in boiler and cooling tower.

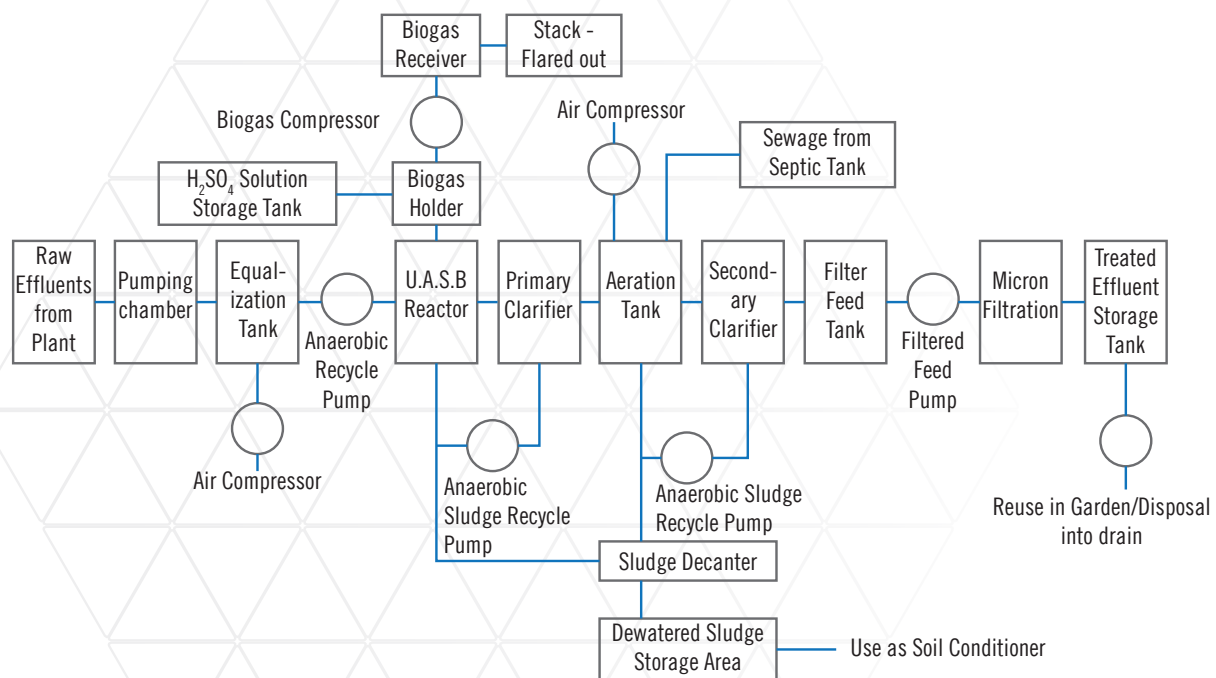
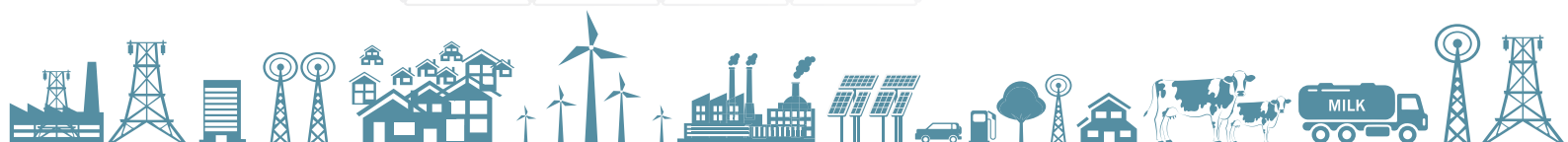

Figure 45: ETP Treatment Process



Currently the Biogas generated from the ETP is flared out through stack. Total biogas generated is 400-425 m³/d at design loading of 300 m³/d effluent flow and 4,000 mg/l COD, which has a C.F. value equivalent to 23,430 kJ/ m³.

Proposed System

It is recommended to install biogas engine with generator to produce electricity from biogas rather than flaring it out. Biogas production will be continuous and for 24 hours a day. The organic fraction of the solid waste has been recognized as a valuable resource that can be converted into useful products using microbes. Anaerobic digestion is a well-established technology for treatment of organic wastes. Biodegradation of the organic wastes in the absence of oxygen produces biogas, which is a mixture of methane and carbon dioxide as major components and traces of hydrogen, ammonia, hydrogen sulphide, etc. Biogas can be used for thermal applications, such as water heating, drying, boiler fuel, etc., or for electricity generation. The digested material available after the anaerobic treatment may be used as a soil conditioner after composting/ vermicomposting. Dual benefits reaped using anaerobic digestion processes for organic solid waste are simultaneous removal of organic pollutants and waste stabilization as well as production of renewable energy in the form of biogas.

The biogas holder will have about 1 m³ storage volume. This biogas will be transferred to biogas holder for intermediate storage. Then the gas will be pumped through a compressor and stored in a biogas capsule. It will be then used in the biogas engine. The estimated potential of generation is 90-950 kWh/day, which is around 40 kW generation considering a generator efficiency of 37% and gas availability of 85%.



Figure 46: Biogas Generation and Utilization Process

Benefits of new system

- ❖ Proper disposal of dairy effluents leads to arresting release of methane to atmosphere.
- ❖ Capturing methane from effluents provides an alternative source of energy.

Limitations

- ❖ High investment cost.

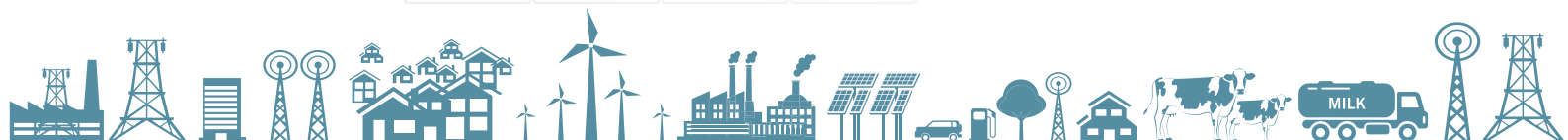

Cost Benefit Analysis

The expected electricity savings by 40 kW Biogas power generator is 2,51,989 kWh annually. The annual monetary saving for this project is **INR 16.12 lakh, with an investment of INR 31.86 lakh, and a simple payback period of 24 months.**

Table 77: Cost Benefit Analysis – Biogas Power Generator

Parameters	UOM	
COD Inlet	mg/l	4,000
COD after anaerobic Digestion and before polishing	mg/l	600
Flow	m ³ /day	300
COD Reduction	mg/lit	3,400
CH ₄ Generation Potential	m ³ /kg COD	0.4
CH ₄ Generation per day	m ³ /day	408
GCV	kJ/m ³	23,430
Energy Generation per day	kJ/day	95,59,603
Generator Efficiency	%	35
Power Generation	kW	38.74
Biogas Availability	%	85.00
No of operating hours	hrs/day	24
No of days	days/year	365
Annual Electricity Generation	kWh	2,88,489
Annual Auxiliary Power Consumption @ 100 units per day	kWh	36,500
Total Electricity Generation	kWh/year	2,51,989
Electricity Cost	INR/kWh	6.4
Annual Savings	INR lakh	16.12
Investment	INR lakh	31.86
Pay Back	months	24
IRR	%	71.44
NPV at 70 % Debt (12% rate)	INR lakh	67.14

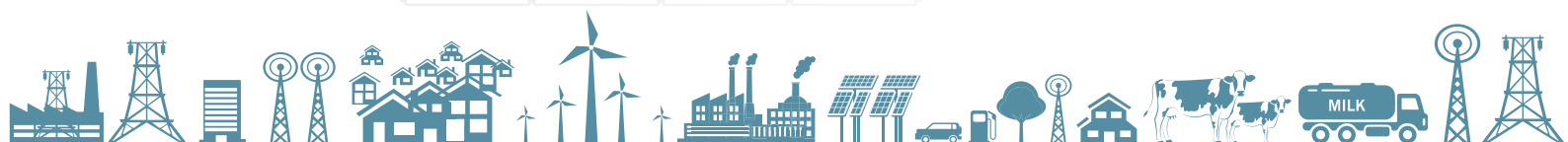

Energy & GHG Savings



Reference Plant Implementation

Table 78: Reference Plant Implementation – Biogas Utilization

Project Name	Methane capture from dairy effluents
Objective	To capture methane from dairy effluents and used as a fuel
Unit profile	Amul Fed Dairy is a large-scale dairy unit located at Gandhinagar, Gujarat. The various products manufactured in AFDG dairy are liquid milk, butter milk, flavored milk, lassi, ghee and ice cream with an average milk processing capacity of 32 lakh LPD.
Installation Photo	-
Assumptions Made	<ul style="list-style-type: none"> ❖ COD load per day – 13,600 kg/day ❖ Operating days – 360 ❖ GCV of biogas – 25,104 kJ/m³ ❖ Gas potential is 50 m³/day ❖ NG cost – INR 28/m³
Savings (INR lakh)	₹ 288
Investment (INR lakh)	₹ 250
Simple Payback Period	11 months
Replication Potential	In all large dairy units (> 10 lakh LPD) and cattle farms
Outcomes	<ul style="list-style-type: none"> ❖ 2,874 m³/day natural gas equivalent biogas generation. ❖ 864 TOE of annual energy savings. ❖ 459 T CO₂ reduction per year.
Unit contact details	Mr. Prashant Seth Amul Fed Dairy Plot No 35, Gandhinagar, Ahmedabad Road, Bhat, Gujarat Phone: 07574802084, Email: prashant.sheth@amul.coop
Cluster Reference	Gujarat Dairy Cluster

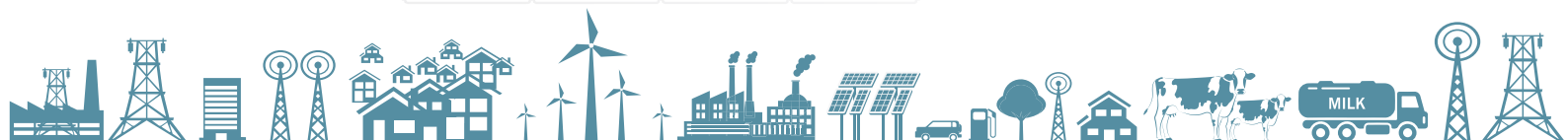

Vendor Details

Table 79: Vendor Details – Biogas Utilization – Power and CNG

Equipment Detail	Biogas Power Generator
Supplier 1	
Supplier Name	Environponics Solutions Pvt Ltd
Address	9, New Natraj Park Society, Bopal Ghuma Road, Bopal, Near India Colony, Bopal, Ahmedabad, Gujarat 380058
Contact Person	Mr. Deep Modi
Mail Id	environponics@yahoo.com
Phone No	+91 9825021159
Supplier 2	
Supplier Name	Sun Enviro Technologies Pvt Ltd
Address	Ashok Colony, Plot No. 22, Near Union Bank, Pratap Nagar, Nagpur - 440 025
Contact Person	Ms. Prachi Doye
Mail Id	sunenviro@sunenv.com
Phone No	+91-712-2282608
Supplier 3 (Biogas to Bio CNG)	
Supplier Name	Atmos Power
Address	39/3B & 39/8B, Nana Chiloda Rd, Phase 3, GIDC Naroda, Ahmedabad, Gujarat 382330
Contact Person	Mr Navneet
Mail Id	mkt@atmospower.net
Phone No	+91 9099903701

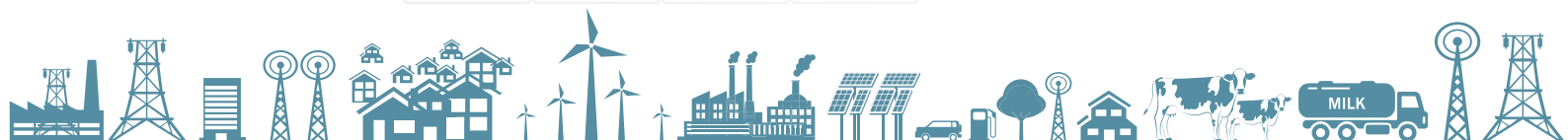

4.4.5 IoT based Water Management System

Baseline Scenario

Water is an important utility for dairy plants as it governs the hygiene of plants. In the past, abundant and inexpensive sources of water were taken for granted in the dairy processing industry and not much thought was given to economize its use. But, in recent times we have witnessed acute water scarcity and drought conditions in various parts of Karnataka, Tamil Nadu, Andhra Pradesh, Maharashtra, Gujarat, and Rajasthan. With the available water sources becoming scarce, many dairy plants, located in such areas, find it difficult to operate or otherwise expand their operations.

On an average, currently, the dairy unit processes roughly about 250,000 litres of milk per day. The milk brought into the plant first is chilled, stored, filtered, clarified and then sent into the central processing unit. Here at the central processing unit the milk that is brought into the plant starts its processing journey. It is pasteurized, homogenized, and the cream is separated. After this, the processed milk is sent into other units of the plant to pack or make by-products out of. Water is consumed at various points in the facility either as RO water, soft water or raw water. The source of water is either from the nearby borewells or external vendor purchases. The water being used at the central processing unit is water from the RO plant through the pump house. The line which carries water from the RO output splits into two lines; one feeding the central processing unit and the other feeding the ultra-heat treatment plant. Roughly, about 400,000 litres of water is used daily. Certain lacuna observed at the site include the following:

- ❖ Facility's mechanical engineering team had personnel to note down the values - manual errors made while noting down the reading was plausible.
- ❖ Location of meters at far off places – Hard to reach, as well as occupational hazards.
- ❖ No real-time data of water being consumed since values were noted down only once a day.
- ❖ Plausible inaccurate and inefficient meter reading led to inaccurate costing of the products.
- ❖ Inaccurate production efficiency calculations.

Dairy processors, therefore, are aggressively challenged to conserve water, necessitating the need for not only reducing water consumption but also employing water management solutions to ensure tracking of the usage.

Proposed System

Water management is an activity of planning, developing, distributing and optimum use of water resources under defined water policies and regulations. Indiscriminate use of water results in excessive wastewater generation, which becomes a burden for the dairy in terms of treatment and disposal costs. The IoT system measures the water consumption at various points within the infrastructure and calculates the total water usage and the health of the infrastructure. This consumption pattern is compared with other days, weeks and months' data to ensure a healthy water infrastructure is maintained. The architecture is based on IIoT

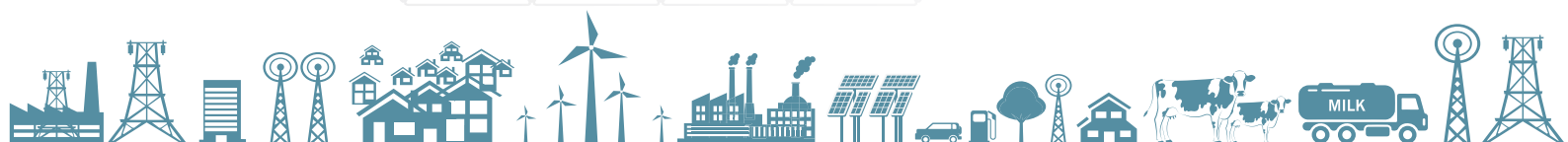

(Industrial Internet of Things), which is a recent technology. The function monitors the level of the water in OHTs and sumps, ensuring the availability of enough water. Moreover, the user, such as the ground staff or plant manager, can interact with the dashboard using the mobile application or remote desktop application.

Merits

- ❖ Real-time productivity and water consumption monitoring
- ❖ Helping the executive of the firm keep track of productivity trends and monitor assets
- ❖ Identifies potential inefficiencies in water consumption
- ❖ CIP process monitoring in real-time
- ❖ Monitors section-wise consumption of the plant, identifies production and cleaning
- ❖ Tracks and monitors borewell, water pump operations
- ❖ Monitors every shift-wise consumption to track plant operation effectively
- ❖ Provide vigilance over the water infrastructure (RO plant, softener, ETP)
- ❖ Excess consumption detection and notifications
- ❖ Alerts to help make ground staff aware about leakage, wastage and overconsumption
- ❖ Suitable for outdoor installations
- ❖ Helps identify the health of RO and softener plants
- ❖ Quarterly consultant visits by our technical team with water experts along with monthly reports, which helps in water auditing

Limitations

- ❖ Replacement of mechanical flowmeters in infrastructure with digital meters

Cost Benefit Analysis

The annual monetary saving for this project is **INR 1.70 lakh, with an investment of INR 1.12 lakh, and a payback period of 08 months.**

Table 8o: Cost Benefit Analysis – IOT Based Water Management System

Parameters	UOM	
Measurement point Cost	INR	1,10,000
Total water Consumption daily	INR	12,000
Per kL	INR	69
Average monthly increment tariff per kL	INR	0.5
Number of consumption points	Nos	17
Number of level measurement points	Nos	4

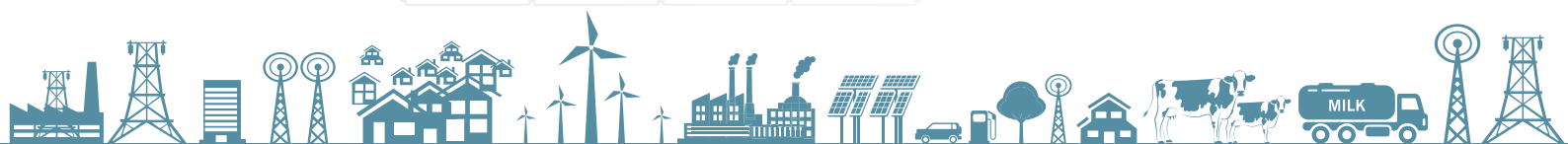

Parameters	UOM	
Minimum Consumption error Expected at one point	%	1
Energy and Maintenance Savings	INR	10,000
Monetary Savings	INR lakh	1.12
Investment	INR lakh	1.70
Pay Back	months	8
IRR	%	181.12
NPV at 70% Debt (12% rate)	INR lakh	8.10

Reference Plant Implementation

Table 81: Reference Plant Implementation – IOT based water management system

Project Name	IoT based water management system	
Objective	To conserve the water, use in dairy industry - IoT based water management tool	
Unit profile	Winner Dairy was established on 25 January 1993 at Pondicherry. It is involved in Manufacture of dairy product and production of raw milk. Winner Dairy's daily production unit outlet processes nearly 2,50,000 litres of milk every day, and produces milk-based by-products as well.	
Installation Photo		
Assumptions Made	<ul style="list-style-type: none"> • Total water consumption at the facility • Cost incurred in water infrastructure • Expenditure in electricity due to water infrastructure • Operating hours of the plant 	
Savings (INR lakh)	₹ 1.70	
Investment (INR lakh)	₹ 1.10	
Simple Payback Period	8 months	
Replication potential	All dairies and milk chilling centers irrespective of size	
Outcomes	<ul style="list-style-type: none"> ❖ Excess consumption detection, alerts and notifications leading to a reduction in water usage translating to monetary savings ❖ Real time productivity and water consumption monitoring ❖ Help the executive of the firm to keep track of productivity trends and monitor assists. 	

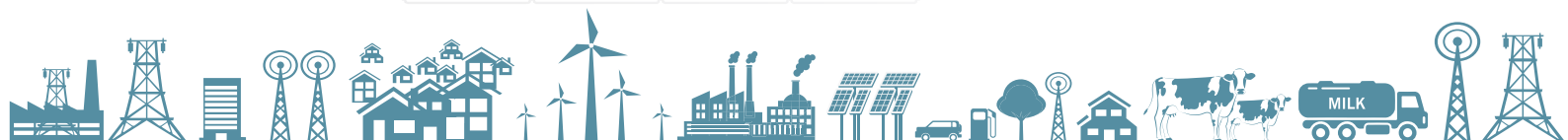

Project Name	IoT based water management system
Unit contact details	Mr. Ayyanar Winner Dairy Email : er.sp.senthil@gmail.com Phone: +91 8883054141
Cluster Reference	Tamil Nadu, Pondicherry

Vendor Details

Table 82: Vendor Details – IOT Based Water Management System

Equipment Detail	IoT based water management system
Supplier Name	FluxGen Engineering Technologies
Address	1064, 1st floor, BTM layout 2nd Stage, Bangalore
Contact Person	Mr. Ganesh Shankar
Mail Id	ganesh@fluxgentech.com
Phone No	+91 9731925888

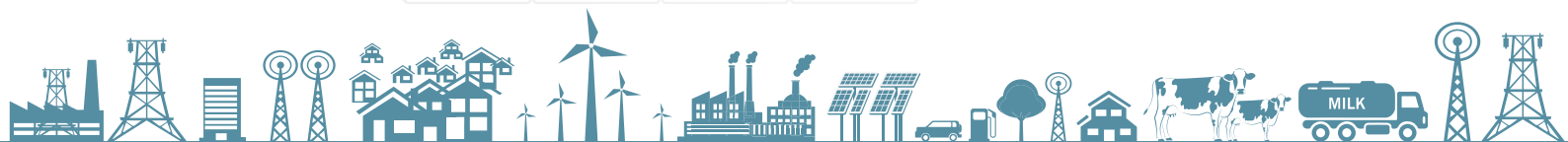

4.5 Case Studies – Process Area

4.5.1 Installation of High Regenerating Efficiency Pasteurizer

Baseline Scenario

A 2.20 Lakh LPD plant was utilizing old pasteurization with regenerative efficiency of 84%. The plant had various products such as skim milk, curd, CIP, crate washing system, etc. The heating process of the Pasteurizers is done with the help of steam. The generation pressure of steam is 8.5 kg/cm² and is utilized in various locations of the plant. The pasteurization was done at a temperature of 77°C with a holding time of 15 seconds. A hot water is heated first with a direct heating system from steam. The hot water is later used for CIP process. The steam utilized at pasteurization is 3 kg/cm².

In HTST pasteurization regenerative preheating is given to the incoming whole milk. After the preheating section the milk is taken through the separator wherein the cream is separated. The skim milk is then taken through heating with an external medium, to a desired temperature along with the required holding time. After which the milk passes through the regenerative cooling section and cooling through external medium. The schematic of the pasteurization process is provided in the figure below.

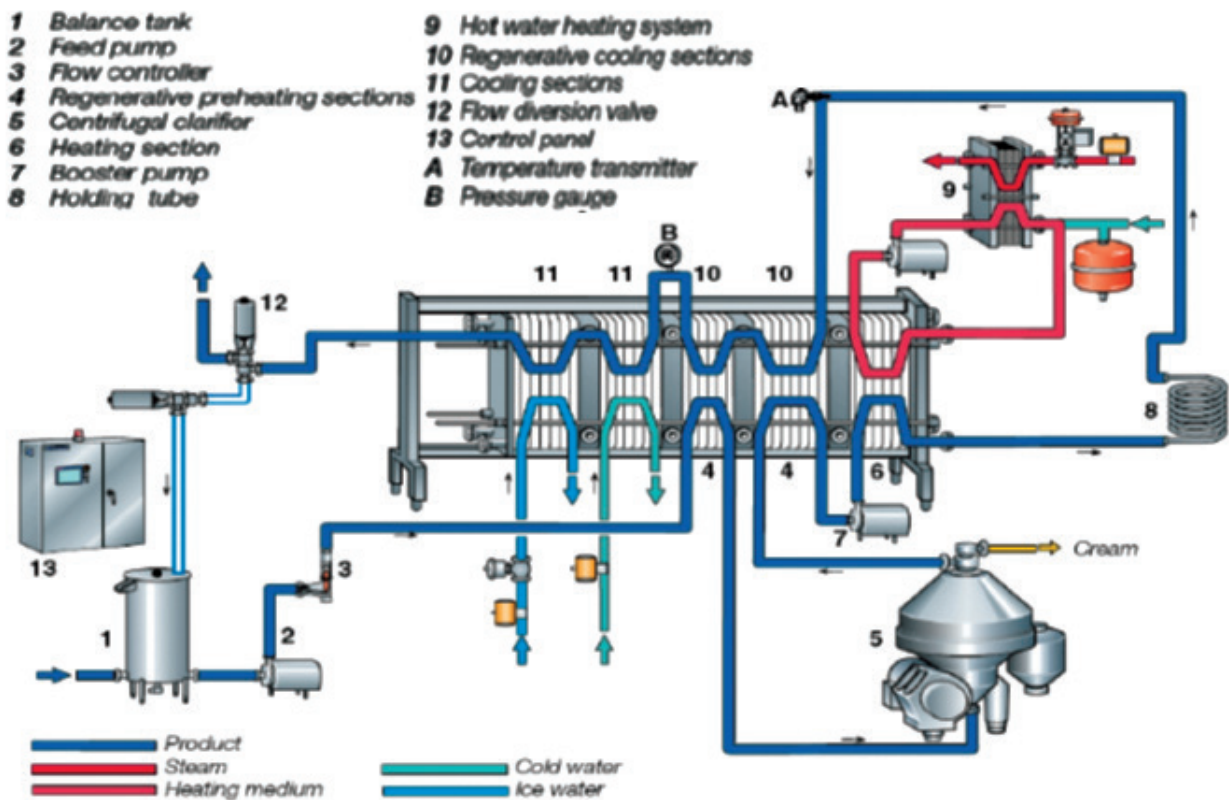

Figure 47: Pasteurization process

The temperatures at different section of the Pasteurizer is mentioned in table . The temperatures in the table show for a Pasteurizer with 84% regeneration. In this plant briquette fired boiler is used with a pressure generation of 8.5 kg/cm² and with boiler operating at an efficiency of 75%.

Proposed System

The design comparison of an 84% and high regeneration pasteurization of 93% is provided in the table below. The temperature of the hot water utilized to heat the milk is working with a temperature difference of 12°C. The plant team explored the opportunity with high efficiency Pasteurizer with a temperature difference of 4°C, significantly reducing the quantity of steam used for heating. The new 93% regenerative Pasteurizer has a wider gap for heat exchange and will occupy higher area in comparison to standard 84% regeneration Pasteurizer. The high regeneration Pasteurizer not only reduces the requirement of external hot water for heating, but also reduces the chilled water requirement in the plant.

Table 83: Comparison sheet

Media	Parameter	84% Regeneration Pasteurizer		93% Regeneration Pasteurizer	
		Temperature °C	Flow rate LPH	Temperature °C	Flow rate LPH
Chilled water	Outlet	4	30000	4	20000
	Inlet	1.5		2	
Hot water	Outlet	70	12000	78	12000
	Inlet	83		82	
PAST. Milk	Outlet	4	10000	4	10000
Milk	Inlet	80		80	
Milk(External heating with hot water)	Outlet	80		80	
Milk	Inlet	72		75	
Milk(2 nd Stage Preheating)	Outlet	72		75	
Milk	Inlet	45		61	
Milk(1 st Stage Preheating)	Outlet	45		61	
Raw milk	Inlet	4		4	

Merits

- ❖ Reduction in hot water and chilled water requirement
- ❖ Better heat transfer

Limitations

- ❖ High investment
- ❖ Requires Pasteurizer shutdown

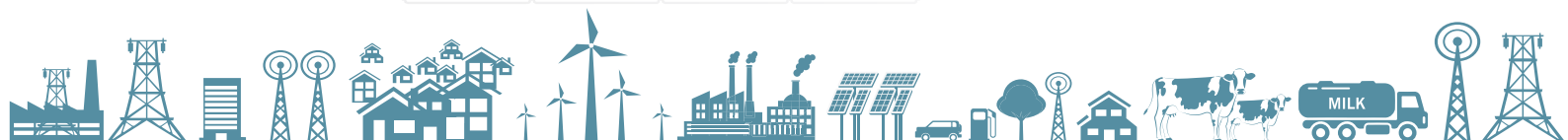

Cost Benefit Analysis

The annual monetary savings to be achieved by installation of high regenerative Pasteurizer is **INR 19.39 lakh, with an investment of INR 15.00 lakh, and a payback period of 24 months.**

Table 84: Cost Benefit Analysis – High regenerative efficiency Pasteurizer

Parameters	UOM	84% Regeneration Pasteurizer	93% Regeneration Pasteurizer	Savings due to regeneration Pasteurizer
Heating requirement from hot water	kJ/h	6,52,704	6,52,704	3,51,456
Cooling requirement from chiller	kJ/h(TR)	3,13,800 (24.8TR)	1,67,360 (13.23 TR)	1,46,440
Energy consumption of hot water taking 75% boiler efficiency	kJ/h	8,70,272	2,67,776	6,02,496
Energy consumption of chilled water system considering 0.9 kW/TR being consumed by the chiller	kW	22.30	11.90	10.40
Annual operating hours	hrs	8000.00	8000.00	
Annual thermal heat requirement	million kJ	52,216	24,099	28,116
Annual electrical chilling	lakh kWh	1.78	0.95	0.83
Cost of thermal energy	INR/million kCal	1667.00	1667.00	0.00
Cost of electrical energy	INR/kWh	6.00	6.00	0.00
Annual Cost of thermal energy consumed	INR lakhs	20.80	9.60	11.20
Annual Cost of electrical energy consumed	INR lakhs	10.70	5.71	4.99
Total cost of energy consumed	INR lakhs	31.51	15.31	16.19
Total savings with 93% regeneration Pasteurizer	INR lakhs		16.19	
Investment for high regenerative Pasteurizer	INR lakhs		15	
Payback period	months		11	
IRR	%		176.34	
NPV at 70 % Debt (12% rate)			77.00	

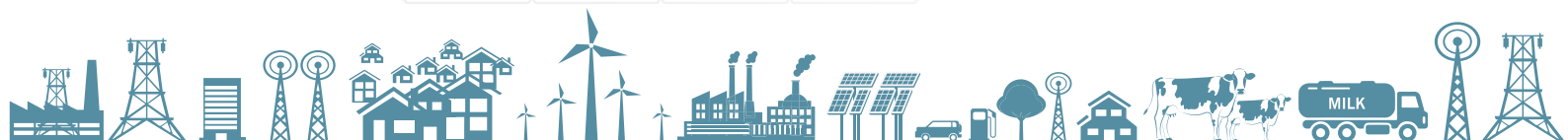

Energy & GHG Savings



Vendor Details

Table 85: Vendor details - High regenerative Pasteurizer

Equipment Detail	Regenerative Pasteurizer
Supplier Name	Alfa laval
Address	Alfa laval India Pvt Ltd Besides Kayes school, Secunderabad 500025
Contact Person	Mr. Vamshi Gaddam
Email Id	Vamshi.gaddam@alfalaval.com
Phone No	9948054222

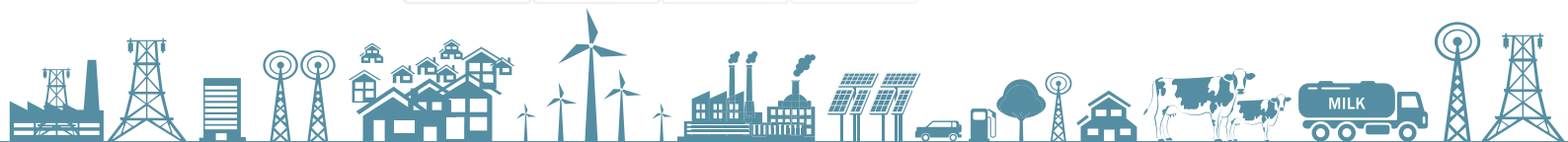

4.5.2 Preheating of incoming milk in curd Pasteurizer

Baseline Scenario

The unit has installed a 5KL curd Pasteurizer for curd processing. The Pasteurizer works for two shifts and 10 KL of curd is produced in a day. The processed milk at 4°C is fed to a balancing tank initially. From balancing tank, the milk goes to the preheating section where it is heated to 45°C using hot water through indirect heating. From preheating section, the milk is fed to the curd Pasteurizer. Inside the Pasteurizer milk at 45°C passes through two sets of regenerative heating and then finally goes to the final heating section where the milk is heated to 110°C using hot water and then holded for 8secs inside the holding section. After holding section, the milk again goes back to the regenerative section for cooling and at the final stage it gets cooled to 43°C using water from cooling tower/condenser. The water after cooling the milk goes back to the cooling tower at higher temperature. After cooling the milk is pumped to the curd processing tank where the culture is added, and agitation is done for 10-15mns. After culturing the curd is packed and then stored in incubation room for 6-8 hrs at 45°C

The unit is not preheating the incoming milk before going to the heating section as a result the steam consumption is more in curd manufacturing process. There is a good potential to preheat the incoming milk using various heat sources available in the plant.

Proposed System

It is recommended to preheat the incoming milk using the water from cooling tower/condenser. This can be done by installing a PHE before the preheating section to heat the incoming milk to 25°C using the raw water from condenser/cooling tower. This will further reduce the temperature of water coming to condenser thereby reducing the load on condenser.

Merits

- ❖ Reduction in fuel consumption
- ❖ Better heat transfer
- ❖ Process time reduces

Limitations

- ❖ Separate PHE for preheating
- ❖ Line modification to be done
- ❖ Increase in water consumption

Cost Benefit Analysis

The annual monetary savings to be achieved by preheating incoming milk is **INR 3.14 Lakhs, with an investment of INR 6.00 Lakhs, and a payback period of 23 months.**

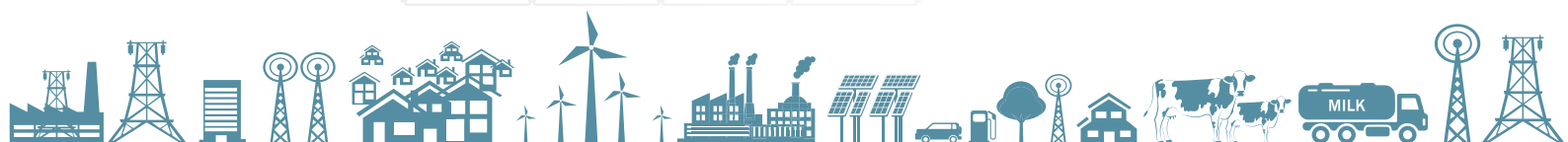
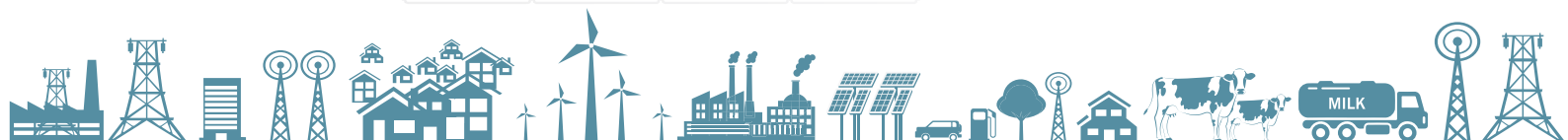

Table 86: Cost benefit analysis - Preheating of milk in curd Pasteurizer

Parameters	UOM	
Pasteurizer capacity	KL	5
Incoming Milk temperature	°C	4
Final heating temperature	°C	25
GCV	kJ/kg	18,409
Boiler Efficiency	%	75
Heat Load	kJ	4,12,960
Fuel savings	kg/hr	29.9
Operating hrs	hrs/day	5.0
Annual Operating days	days	300
Fuel cost	INR/kg	7
Annual Fuel savings	kgs	44,863.63
Annual Cost savings	INR lakh	3.1
Investment	INR lakh	6.0
Payback	months	22.9
IRR	%	72.69
NPV at 70 % Debt (12% rate)	INR lakh	12.96

Energy & GHG Savings



Reference Plant Implementation

Table 87: Reference implementation - Preheating of incoming milk in curd Pasteurizer

Project Name	Preheating of incoming milk in curd Pasteurizer
Objective	To preheat the incoming milk in curd Pasteurizer to
Unit profile	Milma Thrissur Dairy - a unit under Ernakulam Regional Co-operative Milk Producers' Unions (ERCMPU), having its plant at Mannumkad, Ramavarmapuram, Kerala offers pasteurized Vitamin – A enriched milk and products such as Curd and Ghee throughout the state.
Installation Photo	
Assumptions Made	<ul style="list-style-type: none"> ❖ Fuel cost – INR 7/kg ❖ Daily running hours - 8 ❖ Annual operating days – 365
Savings (INR lakh)	₹ 1.5
Investment (INR lakh)	₹ 3000 for piping
Simple Payback Period	Immediate
Replication potential	In all the dairy units irrespective of size having curd Pasteurizer
Outcomes	<ul style="list-style-type: none"> ❖ 33,250 units of energy generated per year ❖ Better availability of power
Unit contact details	Mr. Shaji Mon Dairy Manager Kozhikode Dairy, MRCMPU Region Mail Id : kkddairy@malabarmilma.coop Phone No : 04952800331
Cluster Reference	Kerala Cluster

Vendor Details

Table 88: Vendor details: Plate heat exchanger

Equipment Detail	Plate heat exchanger
Supplier Name	Alfa laval
Address	Alfa laval India Pvt Ltd Besides Kayes school, Secunderabad - 500025
Contact Person	Mr. Vamshi Gaddam
Mail Id	Vamshi.gaddam@alfalaval.com
Phone No	9948054222

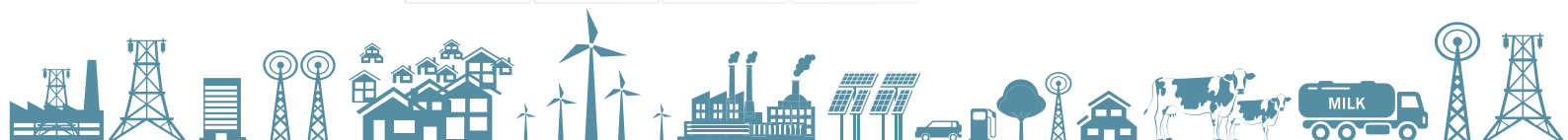

4.6 Case Studies - Renewable Energy

4.6.1 Solar rooftop system

Baseline Scenario

The unit is purchasing electricity from grid for the power requirement in its plant. The contract demand of the plant is 260 kVA, with electricity priced at INR 7.0/kWh, with an average load of 150 kW to 200 kW. The unit has enough rooftop area which can be utilized to install solar PV for self-generation of electricity rather than purchasing from grid. The site specifications for rooftop PV are given below:

Table 89: Site Specification – For Solar PV

Parameters	
Effective Rooftop available	200 sq. m. true south
Location	Latitude: - 10.56° N, Longitude: - 76.24° E
Altitude above sea level, m	7
Direct Normal Irradiance	5 kWh/m ² /day
Wind	2.1 m/sec
Humidity	83%

The following graphs highlights solar irradiance:

Latitude : 10.56 Longitude : 76.24

Annual Average : 5 kWh/m²/day

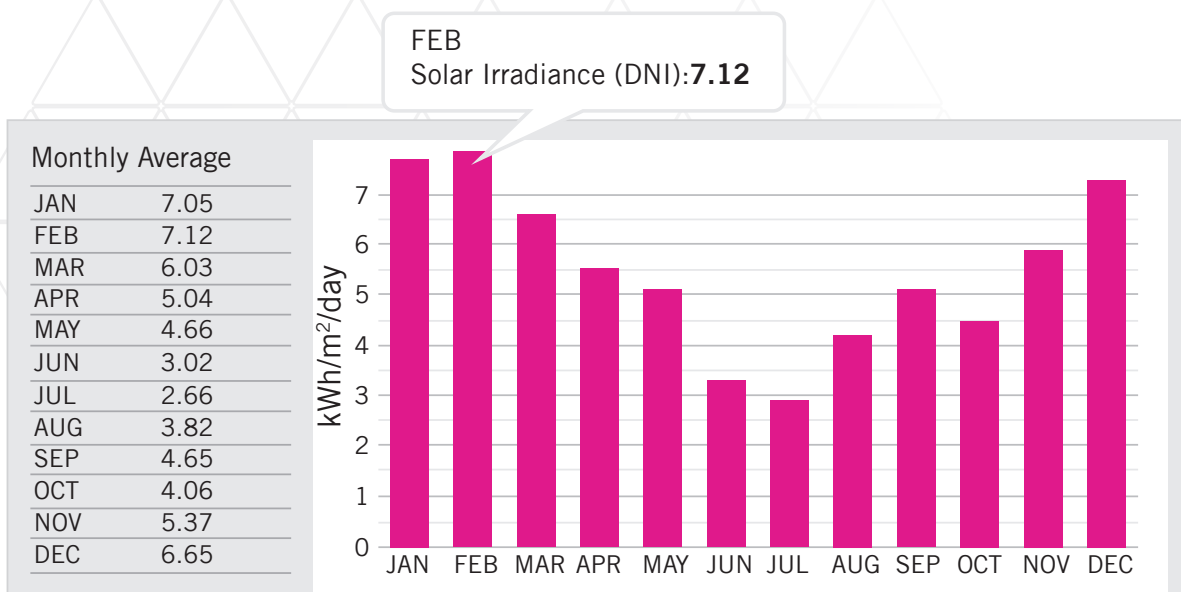
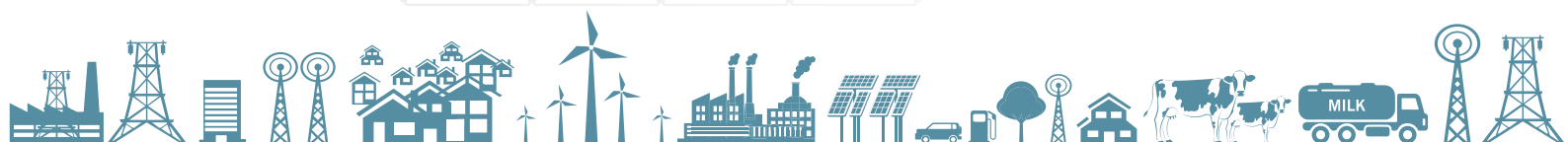

Figure 48: Solar Irradiance



Proposed System

As per the site specifications, the unit has a potential of installing 25 kWp solar rooftop which can generate around 0.40 lakh units of electricity annually. The proposed system will be an Grid Tied Solar PV power plant consisting SPV array, Module Mounting Structure, Power Conditioning Unit (PCU) consisting of Maximum Power Point Tracker (MPPT), Inverter, and Controls & Protections, interconnect cables, junction boxes, distribution boxes and switches. PV Array is mounted on a suitable structure. Grid tied SPV system is without battery and should be designed with necessary features to supplement the grid power during daytime. In grid-connected rooftop or small SPV system, the DC power generated from SPV panel is converted to AC power using power converter, and is fed to the grid either of 33 kV/11 kV three phase lines or of 440V/220V three/single phase line, depending on the local technical and legal requirements. These systems generate power during the daytime, which is utilized by powering captive loads and feeding excess power to the grid. In case the power generated is not sufficient, the captive loads are served by drawing power from the grid.

Net Metering Business Model - The net metering-based rooftop solar projects facilitate the self-consumption of electricity generated by the rooftop project and allows for feeding the surplus into the grid network of the distribution by the licensee. The type of ownership structure for installation of such net metering-based rooftop solar systems becomes an important parameter for defining the different rooftop solar models. In a grid-connected rooftop photovoltaic power station, the generated electricity can sometimes be sold to the servicing electric utility for use elsewhere in the grid. This arrangement provides payback on the investment of the installer. Many consumers from across the world are switching to this mechanism owing to the revenue yield. A commission usually sets the rate that the utility pays for this electricity, which could be at the retail rate or the lower wholesale rate, greatly affecting solar power payback and installation demand. The features/ requirements for Grid Connected Rooftop Solar PV System are as follows:

Table 90: Features/requirements for Grid Connected Solar PV Systems (Rooftop)

S. No.	Features / Requirements	Values
1	Shadow free roof area required	10 m ² /kWp or 100 ft ² /kWp.
2	Roof suitable for Solar PV system	Concrete/ GI/ tin shed (Asbestos may not be suitable)
3	Orientation of the roof	❖ South facing roof is most suitable. ❖ Installation may not be feasible beyond 5 deg slope.
4	Module installation	❖ Modules are installed facing South. ❖ Inclination of modules should be equal closer to the latitude of the location for maximum energy generation.

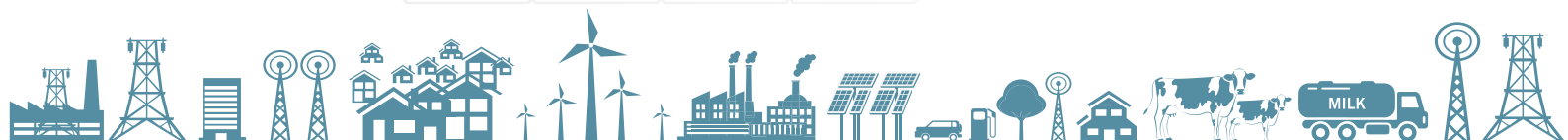

S. No.	Features / Requirements	Values
5	Cost of the Solar rooftop PV system	<p>MNRE issues benchmark cost for GCRT SPV system and the cost for general category states for 2019-20 are as follows. This includes cost of the equipment, installation and O&M services for a period of 5 years.</p> <ul style="list-style-type: none"> ❖ Above 1 kWp and up to 10 kWp: INR 54,000/ kWp ❖ Above 10 kWp and up to 100 kWp: INR 48,000/ kWp ❖ Above 100 kWp and up to 500 kWp: /INR 45,000/ kWp <p>Based on discussions with a few project developers, average cost of the system (as per market conditions) is as follows:</p> <ul style="list-style-type: none"> ❖ For 10 kWp system, INR 49,000/ kWp ❖ For 50 kWp system, INR 42,500/ kWp ❖ For 100 kWp system, INR 37,000/ kWp
6	Useful life of the system	25 years

Merits

- ❖ PV panels provide clean & green energy. During electricity generation with PV panels, there is no harmful greenhouse gas emissions.
- ❖ Technology development in solar power industry is constantly advancing, which can result in lower installation costs in the future.
- ❖ PV panels have no mechanically moving parts, except in cases of sun-tracking mechanical bases; consequently, they have far less breakages or require less maintenance than other renewable energy systems (e.g. wind turbines).

Limitations

- ❖ The initial cost of purchasing a solar PV system is high, which includes paying for solar panels, inverter, batteries, and wiring and for the installation.
- ❖ Although solar energy can be still collected during cloudy and rainy days, the efficiency of the system drops, which results in lower generation of energy.
- ❖ Installing a large PV system takes up a lot of space.

Cost Benefit Analysis

The expected savings by installation of 25 kWp solar rooftop is 40,000 units of electricity annually. The annual monetary saving for this project is **INR 2.60 lakh, with an investment of INR 12.50 lakh, and a payback period of 57 months.**

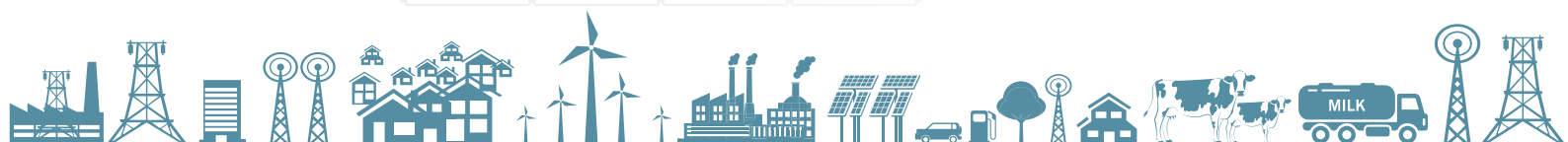

Table 91: Cost Benefit Analysis – Solar PV Systems

Parameters	UOM	
Proposed Rooftop Solar installation	kW	25
Annual units generation per kW of Solar PV	kWh per kW/year	1,600
Total Energy Generation Per Annum	kWh/year	40,000
Electricity Cost	INR/kWh	7
Cost Savings	INR lakh	2.60
Investment	INR lakh	12.50
Payback period	years	57
IRR	%	19.81
NPV at 70 % Debt (12% rate)	INR lakh	4.45

Energy & GHG Savings





Reference Plant Implementation

Table 92: Reference Plant Implementation – Solar PV Systems

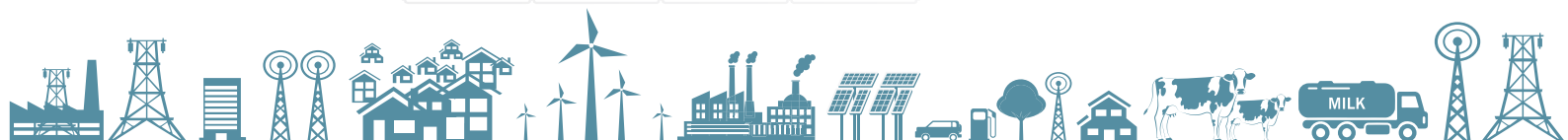
Project Name	Installation of 30 kWp solar PV system
Objective	Installation of 30 kWp grid connected solar rooftop PV
Unit profile	Kozhikode Dairy under MRCMPU Ltd has an average daily procurement of raw milk-6 Lakh Litre and with an average daily sale of processed milk-5 Lakh Litre Other products- Curd, Ghee, Peda, Butter, Butter milk, Ice cream, Palada, Burfi etc



Project Name		Installation of 30 kWp solar PV system	
Installation Photo			
Assumptions Made	<ul style="list-style-type: none"> ❖ Power cost – INR 5.5/kWh ❖ Daily running hours - 8 ❖ Annual operating days – 365 		
Savings (INR lakh)	₹ 1.78		
Investment (INR lakh)	₹ 21		
Simple Payback Period	11 years		
Replication potential	In all the dairy units irrespective of size and milk chilling centers		
Outcomes	<ul style="list-style-type: none"> ❖ 33,250 units of energy generated per year ❖ Better availability of power 		
Unit contact details	Mr. Shaji Mon Dairy Manager Kozhikode Dairy, MRCMPU Region Mail Id : kkddairy@malabarmilma.coop Phone No : 04952800331		
Cluster Reference	Madhya Pradesh Cluster		

Vendor Details

Table 93: Vendor Details – Solar PV

Equipment Detail	Solar PV System
Supplier Name	Varizone Solar Pvt. Ltd.
Address	Shop no. 2/3, Amrut Nagar, Hari Nagar-2, Opp. Swaminaryan Temple, Udhna, Surat
Contact Person	Mr. Parshwa Shah
Email Id	varizonesolar@gmail.com
Phone No	+91 9426111113

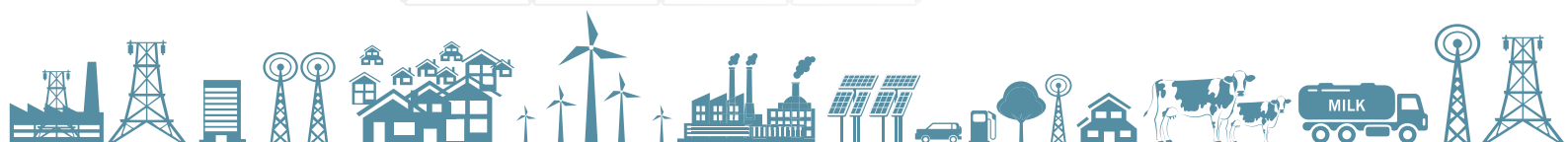

4.6.2 Solar Thermal System

Baseline Scenario

The unit has installed one FO-fired boiler for steam generation, which is used in process applications such as ghee, curd, ice cream section, etc. All the heating process in dairy is through indirect heating. The table below shows the details of the boiler installed in the plant:

Table 94: Boiler Details

Boiler	Fuel Type	Design Capacity (TPH)	Operating Pressure (kg/cm ²)	Operating Condition	Operating hrs
Boiler	FO Fired	1 TPH	9	Running	8

Currently, the temperature of feed water was observed to be 25°C, and there is no mechanism for preheating of feed water inside the plant. The average feed water requirement for the plant during normal running hours is 0.375 TPH and feed water is available at 25°C. The lower the temperature of feed water is, the higher is the fuel consumption inside the boiler to generate steam. For a conventional boiler, increasing the feed water temperature by 15°C will result in an increase in overall thermal efficiency of 3%. There is a good potential to install solar thermal inside the plant to harness solar energy and generate hot water. The site specifications are shown in the table below:

Table 95: Site specifications

Parameters	
Total area available	600 m ² .
Location	Latitude: 10.56° N, Longitude: 76.24° E
Altitude above sea level, m	7
Direct Normal Irradiance	5 kWh/m ² /day
Wind	2.1 m/sec
Humidity	83%
Pressure	1,015 hPa

Proposed System

It is recommended to install 3.5 KL solar thermal system with evacuated tube technology for supplying hot water at 65°C to preheat boiler feed water. Conventional solar thermal system consisting of flat plate collectors have the surface area flat, and as a result, maximum efficiency occurs when the sun is directly overhead at midday. At other times, the sun's rays are striking the collector at varying angles, bouncing off the glazing material, thereby reducing their efficiency.

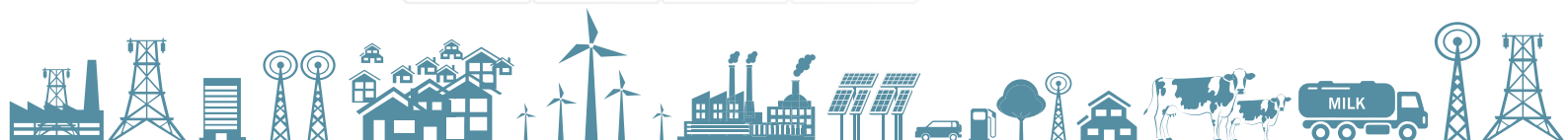

The evacuated tube collector mainly comprises of double glass-walled long evacuated tubes in which the outer surface of the inner tube is coated with a Selective Absorber Coating for solar heat collection. These glass tubes are cylindrical in shape. Therefore, the angle of the sunlight is always perpendicular to the heat absorbing tubes which enables these collectors to perform well even when sunlight is low, such as when it is early in the morning or late in the afternoon, or when shaded by clouds.

Latitude : 10.56 Longitude : 76.24

Annual Average : 5 kWh/m²/day

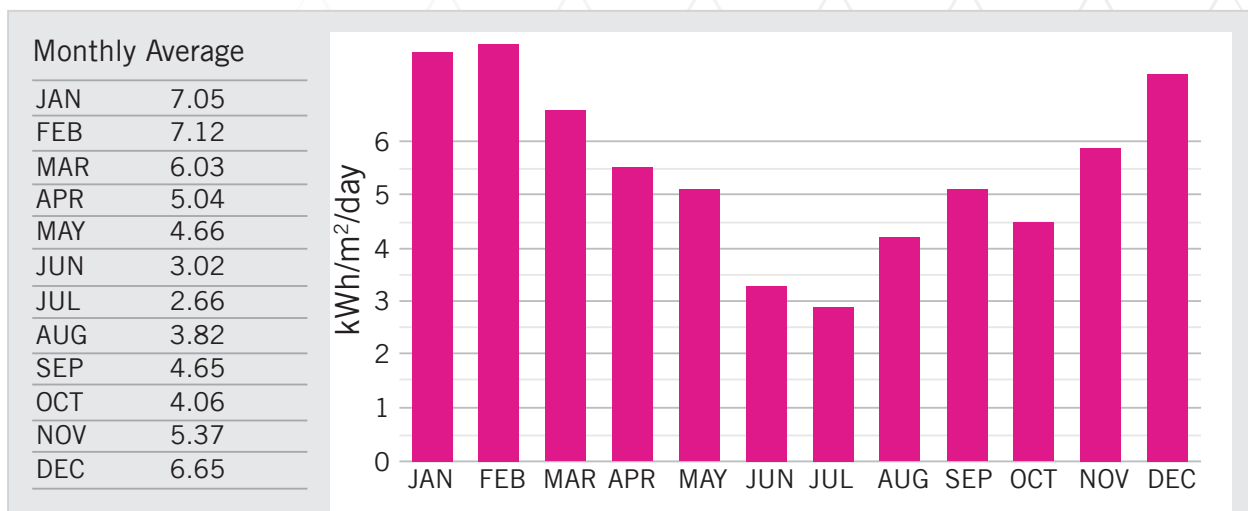

Figure 49: Average Solar Irradiance

Air is removed, or evacuated, from the space between the two tubes to form a vacuum, which eliminates conductive, convective and radiation heat losses. The heat transfer fluid is systematically circulated into the inner tubes where it absorbs the heat from the selective coating – which in turn is continuously heated by the available solar radiation. ETC type is a more efficient solar heat collector (conversion efficiency of over 90%).



Figure 50: Evacuated Tube

Unlike flat panel collectors, evacuated tube collectors do not heat the water directly within the tubes. Instead, air is removed or evacuated from the space between the two tubes, forming a vacuum (hence the name evacuated tubes). This vacuum acts as an insulator reducing any heat loss significantly to the surrounding atmosphere either through convection or radiation making the collector much more efficient than the internal insulating that flat plate collectors have to offer. With the assistance of this vacuum, evacuated tube

collectors generally produce higher fluid temperatures than their flat plate counterparts, so it may become very hot in summer.

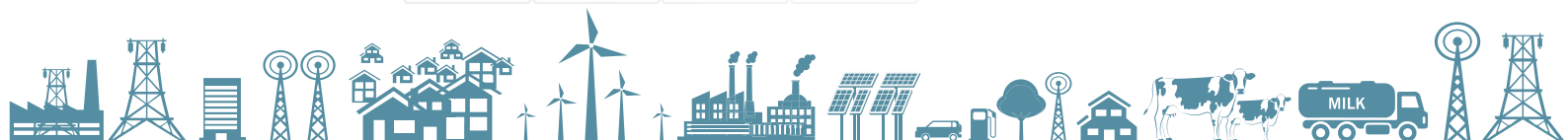

The ETC type collector module is designed with an industrial-grade manifold header type consisting of 30 to 80 tubes. The average rated output of each module is 1 kW for every 12 ETC tubes of 58 mm dia x 1,800 mm length. The average rated output of each module is 1 kW for every 12 ETC tubes of 58 mm dia x 1,800 mm length.

Features of Solar Thermal System

1. Solar thermal Modules

- a. ETC type Solar Thermal Modules.
- b. ETC Glass tubes: 1,800 mm length, OD: 58mm, ID: 48 mm
- c. Total weight of module including structure and filled-water = Approx. 40 kg/m².
- d. End Connection: Both ends of each manifold equipped with flanged end.

2. Module structural Supports – Made of MS L-angle, hot dip galvanized. (Suited for rooftop mounting).

3. Interconnecting pipes between modules – GI; Insulated with 50 mm thick rockwool, and aluminum clad.

4. Area required – Area required for the solar thermal modules: Approx. 4 m²/kW shade-free rooftop area is required for modules, including inter-spaces.

5. Rooftop Load – The distributed load of the ETC Type module and structure will be a maximum of 35 kg/m².

Desired water quality for a long running life of the system:

Table 96: Water Quality Requirement for Solar Thermal

Parameter	Unit	Specifications
Colour		Colourless
Odour		Unobjectionable
Turbidity	NTU	5
pH		6.5 to 8.5
Total Dissolved Solids	mg/l	50
Total Alkalinity	mg/l	20
Total Hardness	mg/l	30
Calcium	mg/l	7.5
Magnesium	mg/l	3
Chloride	mg/l	25
Sulphate	mg/l	20

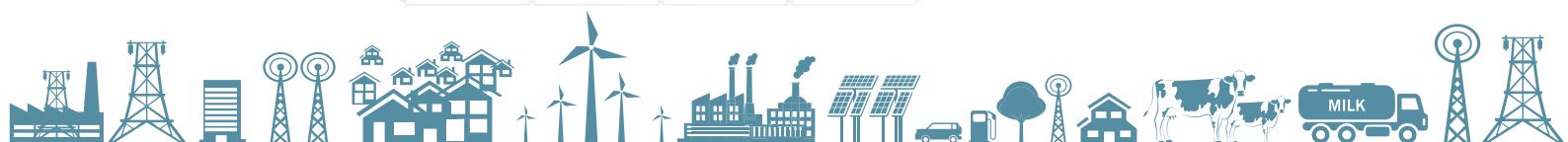

Parameter	Unit	Specifications
Iron	mg/l	0.003
Nitrate	mg/l	4.5
Fluoride	mg/l	1

Merits

- ❖ Reduced dependence on fossil fuels.
- ❖ Solar thermal energy does not cause pollution.
- ❖ Technology development in solar power industry is constantly advancing, which can result in lower installation costs in the future.

Limitations

- ❖ The initial cost of purchasing a solar thermal system is high.
- ❖ Although solar energy can be collected during cloudy and rainy days, the efficiency of the system drops, which results in lesser generation of energy.
- ❖ The area required for installing for large PV system can take up a lot of space.

Cost Benefit Analysis

The expected fuel savings by installation of solar thermal is 4,922 litres of FO annually. The annual monetary saving for this project is **INR 2.21 lakh, with an investment of INR 6.89 lakh, and a payback period of 3.1 years.**

Table 97: Cost Benefit Analysis – Solar Thermal Systems

Parameters	UOM	
Hot water requirement	LPD	3,000
Total boiler operational hours	hrs	8
Temperature required	°C	65
Cost of Furnace Oil	INR/L	45
Boiler Capacity	TPH	1
Boiler Efficiency	%	75
GCV of fuel	kJ/kg	39,580
Hot water requirement per day	LPD	3,000
Feed water temperature	°C	25

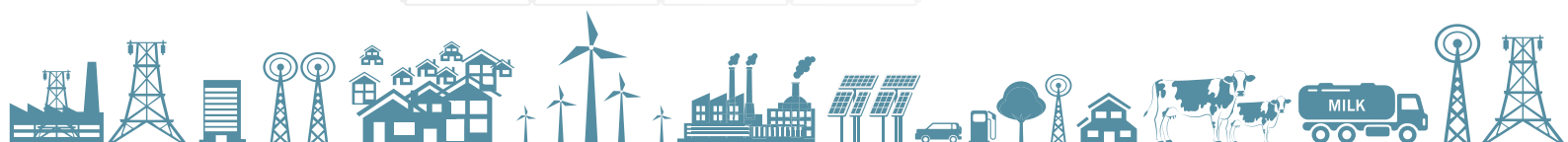

Parameters	UOM	
Heat loss in pipeline	%	15%
Heat energy required to raise the temperature including losses	kJ	5,77,392
Heat energy required to raise the temperature including losses	kW	160.47
Effective sun shine hours	kW	6.00
Heat Energy to be produced per effective hour	kW	27
Selected System Capacity	kW	36
Shadow free roof area required	m ²	144
Fuel saved per day	litres/day	16.41
No of operating days	days	300
Annual fuel savings	litres	4,922
Annual Cost Savings	INR lakh	2.21
Investment	INR lakh	6.88
Payback	years	3.1
IRR	%	48.24
NPV at 70% debt (at 12% rate)	INR lakh	8.07

Energy & GHG Savings

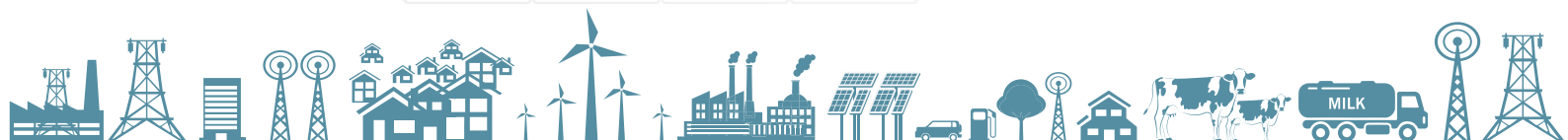

Reference Plant Implementation

Table 98: Reference Plant Implementation – Solar Thermal System

Project Name	Installation of 15,000 LPD Solar Thermal System
Objective	Installation of 15,000 LDP solar thermal system to preheat the boiler feed water
Unit profile	Trivandrum dairy- a unit under Thiruvananthapuram Regional Co-operative Milk Producers' Unions (TRCMPU) of MILMA having its plant at Ambalathara, Trivandrum, Kerala offers pasteurized Vitamin – A enriched milk and various milk-based products such as Butter, Ghee, Paneer, Curd, Butter milk and Ice cream throughout the state.
Installation Photo	
Assumptions Made	<ul style="list-style-type: none"> ❖ Feed water temperature – 28°C ❖ Boiler efficiency – 70% ❖ Fuel Cost – Rs 6.5/kg (Briquette) ❖ Annual working hours - 3600
Savings (INR lakh)	₹ 2.00
Investment (INR lakh)	₹ 21
Simple Payback Period	11 years
Replication potential	In all the dairy units irrespective of size and milk chilling centers
Outcomes	<ul style="list-style-type: none"> ❖ 31,500 kg of briquette saved annually ❖ Annual energy saving of 13 TOE
Unit contact details	<p>Mr. Balasubramony MILMA – Thiruvananthapuram, TRCMPU region Mail Id : milmatdengg@gmail.com Phone No : 0471-2382562, 2382148</p>
Cluster Reference	Madhya Pradesh Cluster

Vendor Details

Table 100: Vendor Details – Solar Thermal Systems

Equipment Detail	Solar Thermal System
Supplier Name	Aspiration Energy
Address	Aspiration Energy Pvt Ltd Mandaveli, Chennai - 600028
Contact Person	Mr. Logesh N
Email Id	logesh@aspirationenergy.com
Phone No	+91 9840409624

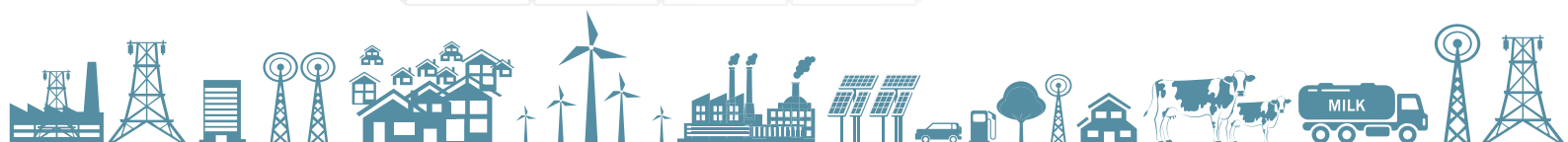

4.6.3 Solar-Wind Hybrid system

Baseline Scenario

The unit is purchasing electricity from grid for the electrical energy requirement. The contract demand of the plant is 450 kVA, with an electricity price of INR 6.5/kWh, and average operating load is 260 kW to 300 kW.

Renewable energy is deemed to be the best substitute for conventional fossil fuel. Implementation of renewable energy posts various challenges, such as capital cost and consistency of power output, of which the latter can be solved by the installation of a Solar – Wind hybrid system. The plant has enough rooftop area which can be utilized to install a solar-wind hybrid system that can harness solar energy and wind energy to generate electricity.

Proposed System

The Solar – Wind Hybrid system is also known as solar mill. The solar mill generates:

- ❖ Daytime energy from the sun and wind.
- ❖ Day & night energy from the wind energy.
- ❖ Energy even on cloudy days.
- ❖ More energy on hot sunny days due to cooling effect on solar panels by wind.



Figure 51: Solar wind hybrid system

It consists of three vertical axis wind turbines coupled to three permanent magnet generators. Automatic mechanical braking is provided once the wind speed goes beyond the cut-off speed. On board smart electronics include dynamic Maximum Power Point Tracking (MPPT). It uses wind and solar resources on a 24/7/365 basis, allowing access to energy and very little interruption of services. The design life of solar mill is 25 years.

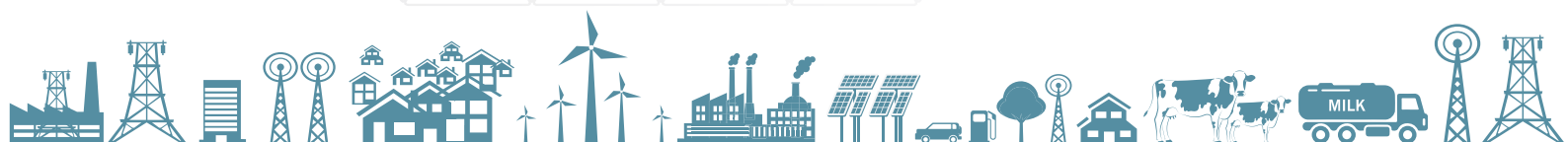

Specifications

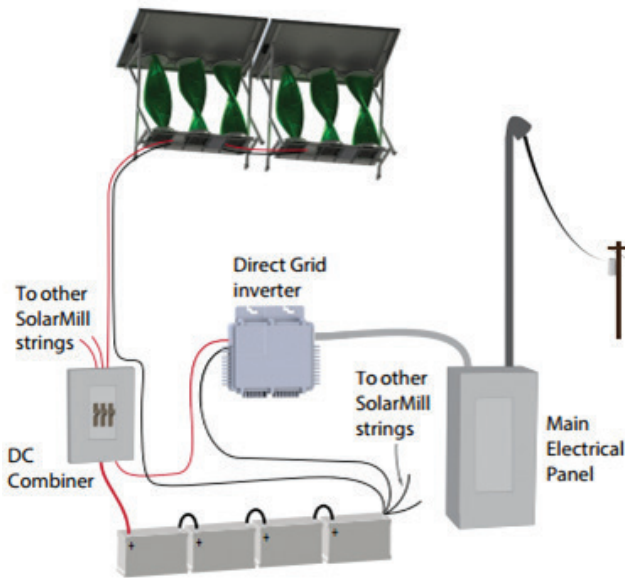

Figure 52 Hybrid mill connected to supply

The increase of renewable power per square foot of roof is obtained by combining two power sources. For a rooftop installation, combining solar and wind power is a complementary combination. For example, many locations are less windy in the middle of the day when the sun is at its peak, and the wind picks up after dusk. Other advantages are solar module providing protection for the wind portions of the mechanism from direct rain and hail, and assisting with the direction of air into the turbines.

Since this compact installation is designed for rooftops and urban atmosphere, savonius type of wind turbine is chosen for its low running speed and relative insensitivity to turbulence. Power generation begins at a wind speed of 5 kmph. Independent MPPT for both wind and solar is calibrated. Maximum power point tracking (MPPT) is an algorithm included in charge controllers used for extracting maximum available power. The power from both wind and solar generation is routed into a common 48V DC bus which has built-in charge control for a lead acid battery bank.

Modes of Use

In grid tied system, the bank of batteries is connected to one or more Direct Grid micro-inverters, which connect to the user's electrical panel. The inverters push power back to the grid efficiently when the batteries become fully charged.

In off grid storage, the batteries can be used to supply power to electrical devices in off grid settings. This electrical energy can power DC powered devices through a voltage converter, or can power AC devices through an inverter.

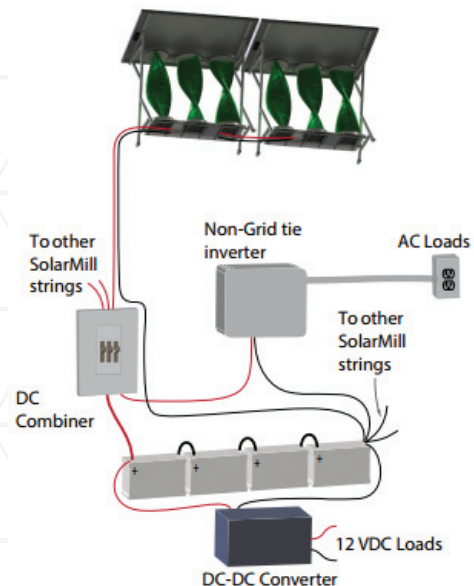
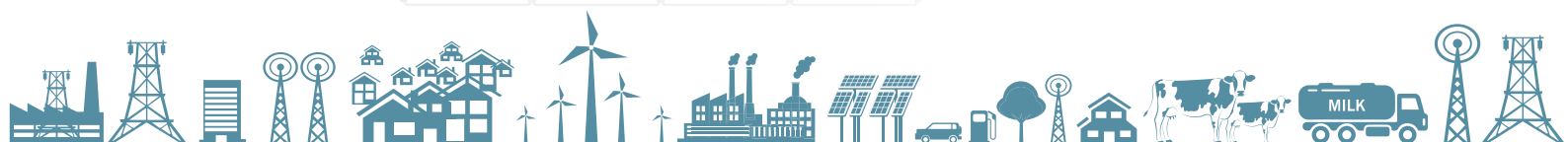

Figure 53 Hybrid mill connected to loads



Merits

- ❖ Power generation during daytime as well as nighttime.
- ❖ Reliable power generation even on cloudy days.
- ❖ A compact hybrid solar mill to meet a portion of the plant's load after detailed study with vendors.
- ❖ Power generation starts at 2-5 m/s and mechanical braking occur beyond 18 m/s.
- ❖ The power generation can be monitored online.

Limitations

- ❖ Higher investment.

Cost Benefit Analysis

The expected savings in electrical energy to be achieved by installation of a 50 kWp Solar - Wind hybrid system is 1,32,000 units annually. The annual monetary saving for this project is **INR 8.60 lakh, with an investment of INR 45.00 lakh, and a payback period of 63 months.**

Table 101: Cost Benefit Analysis – Solar Wind Hybrid Systems

Parameters	UOM	
Installed Capacity of Solar wind Mill	kWp	50
Average generation per day per kWp	kWh	6.0
Area Required	m ²	60
Annual operating days	Days	365
Electricity Tariff	INR/kWh	6.5
Average Annual Energy Saving on conservative basis	kWh	1,09,500
Annual cost savings	INR lakh	7.11
Investment	INR lakh	50
Simple Payback Period	Years	7
NPV at 70% Debt (12% rate)	INR lakh	13.15
IRR (%)	%	20.88

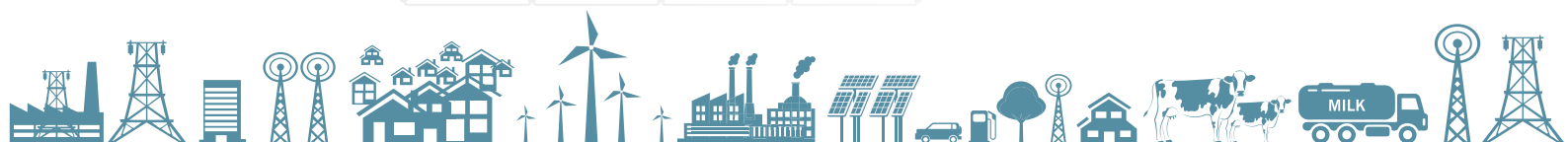

Energy & GHG Savings



Vendor Details

Table 102: Vendor Details – Solar-Wind Hybrid Systems

Equipment Detail	Solar - wind hybrid system
Supplier Name	Windstream Technologies
Address	G2-SSH Pride, Plot 273, Road No-78, Jubilee Hills, Hyderabad 500096
Contact Person	Mr. Bhaskar Sriram
Email Id	bhaskars@windstream-inc.com
Phone No	+91 99599 18782

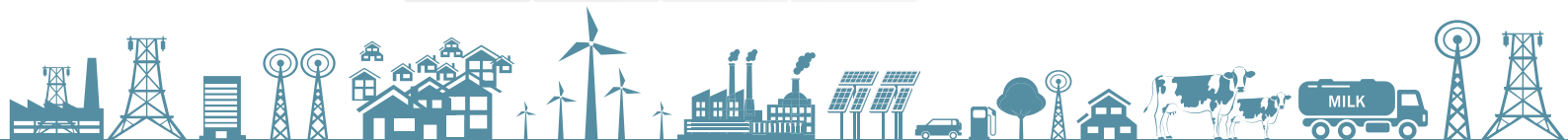

5. Conclusion

In a typical dairy plant, heating and cooling operations are dominant energy users. Due to the wide variation in product mix among the dairy units, overall energy and specific energy consumption indicators vary significantly from plant to plant, making it extremely difficult to compare for performance or for identifying efficiency improvement opportunities. Other reasons for such wide variation also include level of technology adopted, vintage of these facilities, capacity utilization and fuel mix used in their operations. Significant energy efficiency improvement opportunities in dairy units exist in heating and cooling applications via adoption of co-generation technology, de-superheaters, evaporative cooling systems, utilization of renewable energy; biomass fired boilers and increased automation. Through this compendium, some of the key technologies that are highly replicable in the cluster have been identified, and for these technologies the case examples are included.

The identified technologies can be categorized into three heads, namely, Level 1, Level 2, and Level 3, based on the investment requirement and the payback, as follows:

- ❖ **Level 1:** Low investment
 - ❖ VFD for chilled water pumps
 - ❖ Steam operated pumping traps
 - ❖ VFD in chiller compressor
 - ❖ Thermal energy storage for BMC
 - ❖ VFD for air compressor
 - ❖ Energy Efficient Pumps
 - ❖ De-superheater for chiller compressor
 - ❖ IoT for water management
 - ❖ kVAr Energy Compensator for Chiller Compressor
 - ❖ Energy Efficient Agitator for IBT
 - ❖ BMC remote monitoring system
 - ❖ Preheating of incoming milk in curd Pasteurizer
- ❖ **Level 2:** Medium investment
 - ❖ Condensate recovery system
 - ❖ Solar Thermal system
 - ❖ Replacement of low speed reciprocating compressor with high speed reciprocating chiller

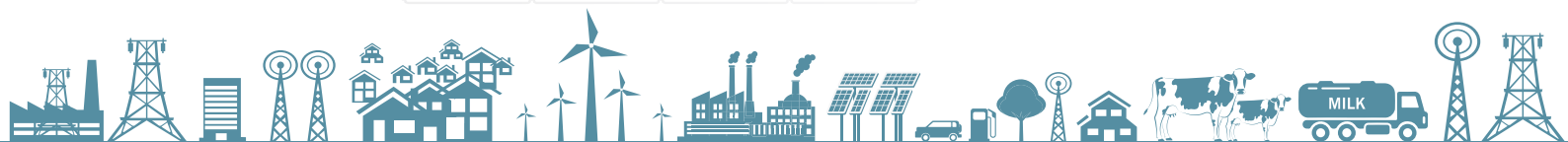

❖ **Level 3:** High investment

- ❖ Package type bio reactor
- ❖ Solar rooftop system
- ❖ Conversion of furnace oil fired boiler to intelligent biomass fired boiler
- ❖ Direct cooling method – IBT
- ❖ Methane capture from dairy effluents
- ❖ Installation of screw refrigeration compressor with VFD
- ❖ Double effect steam driven vapour absorption chiller heater
- ❖ Solar wind hybrid system
- ❖ Installation of High Regenerating Efficiency Pasteurizer

Table 103: Summary of Energy conservation measures

Sr. No.	Technologies	Ease of Implementation			Priority of activity (based on PB)		
		Easy	Moderate	Difficult	Short	Medium	Long
Steam Generation and Distribution							
1	Conversion of Furnace Oil Fired Boiler to Fully Automated Biomass Fired Boiler			√			√
2	Condensate Recovery System		√		√		
3	Steam Operated Pumping Traps	√				√	
Refrigeration Systems							
4	Installation of Screw Refrigeration Compressor		√				√
5	VFD in Chiller Compressor	√				√	
6	Evaporative Condensers		√			√	
7	Energy Efficient Agitator for IBT	√			√		
8	Falling Film Chiller		√			√	
9	Direct Cooling Method – IBT			√			√
10	Double effect steam driven vapour absorption chiller heater			√			√
11	Desuperheater for Chiller Compressors	√				√	
12	kVAr Energy Compensator for Chiller Compressor	√				√	
13	VFD for chilled water pumps	√			√		

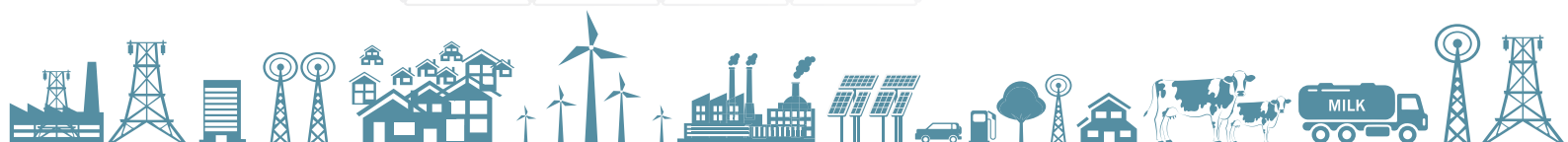

Sr. No.	Technologies	Ease of Implementation			Priority of activity (based on PB)		
		Easy	Moderate	Difficult	Short	Medium	Long
Bulk Milk Coolers							
14	Thermal Energy Storage for BMC	√			√		
15	BMC Remote Monitoring System	√				√	
Utilities							
16	VFD for Air Compressor	√			√		
17	Energy Efficient Pumps	√				√	
18	Package Type Biogas Reactor		√				√
19	Methane Capture from dairy effluents			√			√
20	IoT based Water Management System		√		√		
Process							
21	Installation of High Regenerating Efficiency Pasteurizer			√		√	
22	Preheating of incoming milk in curd Pasteurizer		√			√	
Renewable Energy							
23	Solar rooftop system	√					√
24	Solar Thermal System		√				√
25	Solar-Wind Hybrid system	√					√

The energy efficiency/renewable energy projects detailed in the case studies in this compendium indicate that there is a good potential for benefits in both low hanging and medium-to-high investment options. The dairies can implement the low hanging fruits (with smaller investments) faster, as with minimum or no investments, several savings can be achieved. However, for the high investment projects, a detailed review in the form of DPR can be prepared. The attractiveness of the project can also be assessed from the unit abatement cost (UAC). The UAC is defined as the cost/investment of reducing one unit of energy or pollution. The options having lower UAC are attractive to reduce a unit of energy consumption as lower investments are required to achieve energy savings. The following graph highlights the comparison of Unit Abatement Cost as Investment (INR Lakh)/Energy Saving achieved (TOE), for the major proposals identified at the Madhya Pradesh Dairy cluster.

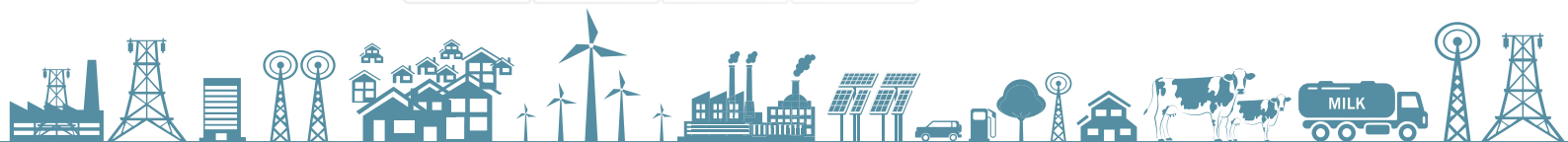

UAC: INVESTMENT (INR LAKH)/ENERGY SAVINGS (TOE)

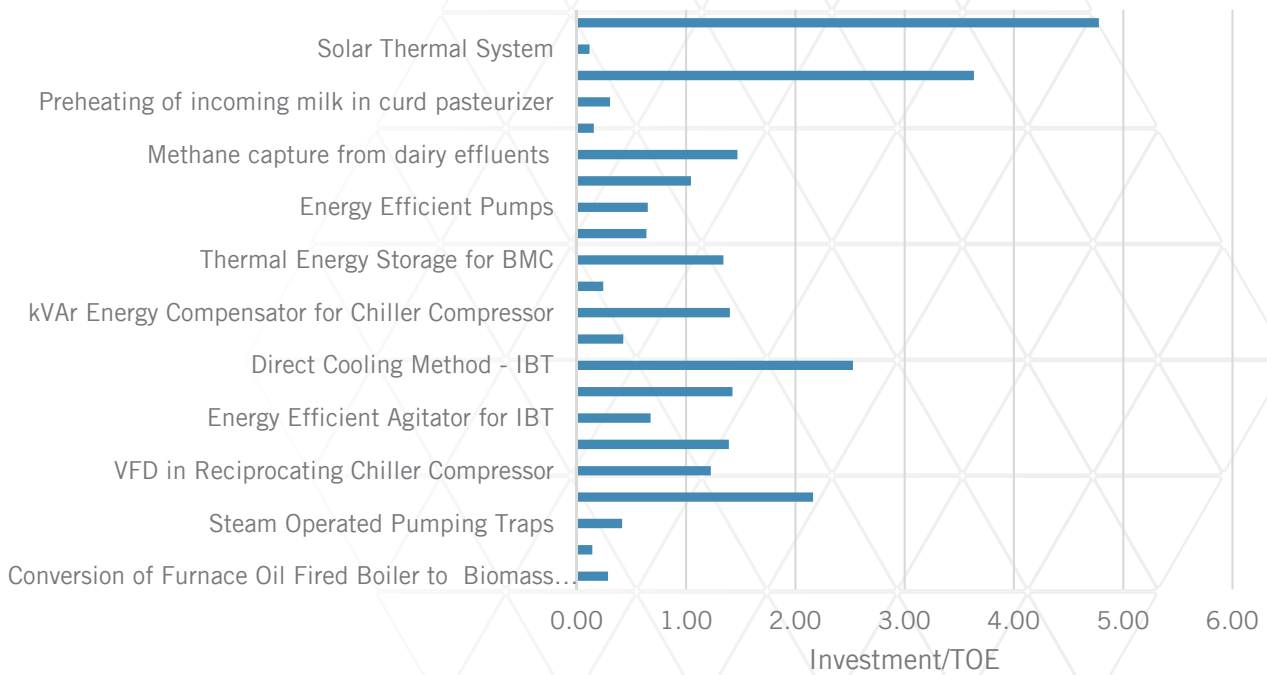
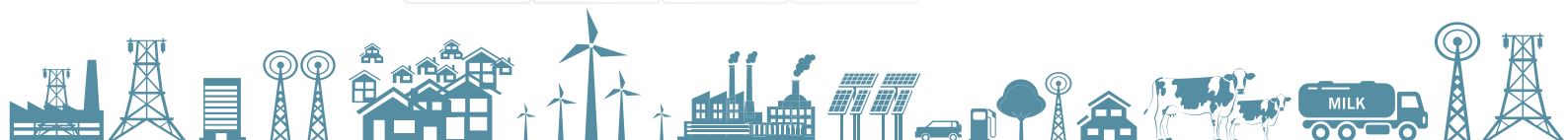

Figure 54: Unit Abatement Cost - Energy Efficient Technologies

The Madhya Pradesh dairy industry should view this manual positively and utilize this opportunity to implement the best operating practices and energy saving ideas during design and operation stages, and thus move towards achieving world class energy efficiency.



Bibliography

1. DAHD, G. (2018). National Action Plan for Dairy Development - Vision 2022. New Delhi: Department of Animal Husbandry, Dairying and Fisheries, Ministry of Agriculture, Government of India.
2. FAO. (2019, November 25). Retrieved from Gateway to dairy production and products: <http://www.fao.org/dairy-production-products/production/en/>
3. GCMMF. (2019, November 29). About Us. Retrieved from Amul: <https://amul.com/>
4. GLPCL. (2019, November 29). Gujarat Livelihood Promotion Company Limited. Retrieved from Gujarat Livelihood Promotion Company Limited: <http://glpc.co.in/showpage.aspx?contentid=176>
5. NDDDB. (2004). Energy Management in Milk Powder Plants. India: National Dairy Development Board.
6. NDDDB. (2019, November 25). Milk Production in India. Retrieved from NDDDB: <https://www.nddb.coop/information/stats/milkprodindia>
7. Tetra Pak. (2019, November 29). <https://www.tetrapak.com/processing/pasteurization/tetra-pak-Pasteurizer-d>. Retrieved from <https://www.tetrapak.com/processing/pasteurization/tetra-pak-Pasteurizer-d>: <https://www.tetrapak.com/processing/pasteurization/tetra-pak-Pasteurizer-d>

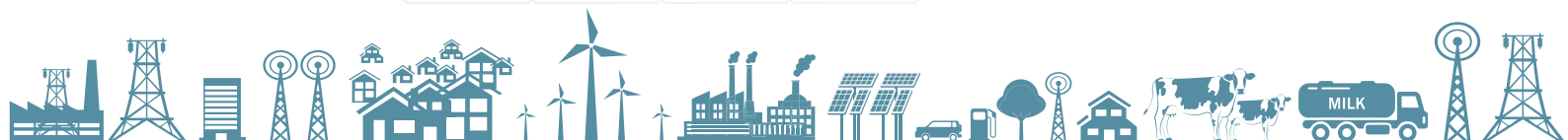

For more details, please contact



**UNITED NATIONS
INDUSTRIAL DEVELOPMENT ORGANIZATION**

Vienna International Centre
P.O. Box 300 · 1400
Vienna · Austria
Tel.: (+43-1) 26026-0
ENE@unido.org
www.unido.org

UNIDO
Regional office in India
UN House
55 - Lodi Estate,
New Delhi-110 003, India
office.india@unido.org



Bureau of Energy Efficiency

Government of India, Ministry of Power

4th Floor, Sewa Bhawan,
R. K. Puram,
New Delhi - 110 066
India
Tel.: (+91) 011 2617 9699-0
gubpmu@beenet.in
www.beeindia.gov.in